

BE AG & INDUSTRIAL

BOOKING PROGRAM

2023

CHAIN HARDWARE PG. 154-155



64.198.002



64.020.038

BUCKET MOUNT ACCESSORIES PG. 129

64.500.705G



64.500.700

ONE PIECE SOLID FORGED HOOKS

HAY CUTTING & RAKING PG. 44-50



55.030.001



BU-215A

55.204.268



45.064.562

45.000.257

LIFTING EQUIPMENT PG. 270-274



35.200.003



35.400.035

HANDHELD SPRAYERS PG. 73



90.704.001



90.704.002



90.704.006

NEW LOW PRICES!



90.704.016



90.700.150

BRABEREQ.COM

PARTS@BRABEREQ.COM

PHONE: 604-850-7770

FAX: 604-850-7774

TOLL FREE PHONE: 1-877-588-3311

TOLL FREE FAX: 1-800-665-7334

NUMERICAL TABLE OF CONTENTS

PAGE	SECTION	PAGE	SECTION
6-11	WHAT'S NEW	131-136	TRACTOR ATTACHMENTS
12	FEATURED ITEMS	137-142	TRAILER ACCESSORIES
13-16	OVERSTOCK	143-150	TRAILER JACKS
17-23	PTO DRIVELINES & COMPONENTS	151-155	CARGO CONTROL
24-25	GEARBOXES	156	LOAD BINDERS
26-33	SEATS - AGRICULTURAL	157-164	CHAIN HARDWARE
34-37	SEATS - LAWN & GARDEN	165-170	SMALL HARDWARE
38-40	SEATS - INDUSTRIAL	171-175	HYDRAULIC
41-44	CULTIVATOR & PLOW PARTS	176-177	TRACTOR ACCESSORIES
45-48	HAYING PARTS	178-185	GREASE GUNS & ACCESSORIES
49-54	SICKLE GUARDS & ACCESSORIES	186-190	WHEEL ASSEMBLIES
55-71	TILLER BLADES & HAMMERS	191-192	SHOP SUPPLIES
72-74	GARDEN HOSES & ACCESSORIES	193-195	SAFETY EQUIPMENT
75-92	SPRAYERS, PUMPS & ACCESSORIES	196	CABLE TIES
93	FITTINGS & SWIVELS	197	SHOP EQUIPMENT
94-96	NOZZLES	198-212	ASSORTED KITS
97-98	SPRAY WANDS & ACCESSORIES	213-219	LED LIGHTS
99	HOSE REELS	220-251	3 POINT HITCH & LINKAGE
100-101	12V & ROLLER PUMPS	252-261	POWER TRANSMISSION PRODUCTS
102	FANS	262-266	RANCH HARDWARE
103-110	POWER EQUIPMENT	267	DIESEL TRANSFER TANKS
111	CAMLOCKS	268	JOB BOXES
112-113	VALVES & ACCESSORIES	269	BOOSTER CABLES
114-121	GAUGES	270	FARM JACKS
122	ENGINES	271-276	LIFTING EQUIPMENT
123-130	LAWN & GARDEN	277-279	RETAIL DISPLAY BOARDS

ALPHABETICAL TABLE OF CONTENTS

PAGE	SECTION	PAGE	SECTION
220-251	3 POINT HITCH & LINKAGE	156	LOAD BINDERS
100-101	12V & ROLLER PUMPS	94-96	NOZZLES
198-212	ASSORTED KITS	13-16	OVERSTOCK
269	BOOSTER CABLES	103-110	POWER EQUIPMENT
196	CABLE TIES	252-261	POWER TRANSMISSION PRODUCTS
111	CAMLOCKS	17-23	PTO DRIVELINES & COMPONENTS
151-155	CARGO CONTROL	262-266	RANCH HARDWARE
157-164	CHAIN HARDWARE	277-279	RETAIL DISPLAY BOARDS
41-44	CULTIVATOR & PLOW PARTS	193-195	SAFETY EQUIPMENT
267	DIESEL TRANSFER TANKS	26-33	SEATS - AGRICULTURAL
122	ENGINES	38-40	SEATS - INDUSTRIAL
102	FANS	34-37	SEATS - LAWN & GARDEN
270	FARM JACKS	197	SHOP EQUIPMENT
12	FEATURED ITEMS	191-192	SHOP SUPPLIES
93	FITTINGS & SWIVELS	49-54	SICKLE GUARDS & ACCESSORIES
72-74	GARDEN HOSES & ACCESSORIES	165-170	SMALL HARDWARE
114-121	GAUGES	75-92	SPRAYERS, PUMPS & ACCESSORIES
24-25	GEARBOXES	97-98	SPRAY WANDS & ACCESSORIES
178-185	GREASE GUNS & ACCESSORIES	55-71	TILLER BLADES & HAMMERS
45-48	HAYING PARTS	176-177	TRACTOR ACCESSORIES
99	HOSE REELS	131-136	TRACTOR ATTACHMENTS
171-175	HYDRAULIC	137-142	TRAILER ACCESSORIES
268	JOB BOXES	143-150	TRAILER JACKS
123-130	LAWN & GARDEN	112-113	VALVES & ACCESSORIES
213-219	LED LIGHTS	6-11	WHAT'S NEW
271-276	LIFTING EQUIPMENT	186-190	WHEEL ASSEMBLIES

WHAT'S NEW

ON PAGES 175-176

18V LITHIUM ION GREASE GUN 67.018.000

- Heavy duty die cast aluminum head
- Air vent (bleeder valve)
- 3 Way loading, 397g (14 oz) cartridge, suction or fast refill bulk loader valve
- Ergonomic handle with rubber grip
- Built in anti-debris filter

30"
EXTRA LONG
GREASE HOSE
WITH BEND
RESTRICTORS

WITH STANDARD
14 OZ
(397G)
GREASE CARTRIDGE
OR WITH
BULK FILLING

DELIVERS APPROX.
3 OZ
PER MINUTE
HIGH FLOW RATE

MAX PSI
10,000
POWERS THROUGH
CLOGGED GREASE
FITTINGS



MINI PISTOL GRIP GREASE GUN PROFESSIONAL / DEVELOPS 4,500 PSI 21.100.001



- Includes 4" pipe and 12" hose
- Heavy Duty zinc die cast vented gun head
- Thick wall steel barrel knurled for secure grip
- Pistol grip with PVC provides secure grip
- 2 way loading
 - 3 oz (85g) grease cartridge
 - Suction fill
- 1.5 oz (43 g) in 100 strokes
- 90° & 180° delivery pipe locations
- Accessible check valve for easy cleaning of hardened / contaminated grease



PROFESSIONAL SERIES

PISTOL GRIP GREASE GUNS 21.100.004



WORKSHOP SERIES

21.100.006



- Includes pipe and hose
- Steel barrel with knurled secure grip
- Pistol grip with PVC grips
- 2/3 way loading
- Includes heavy duty 4 jaw coupler



PROFESSIONAL SERIES

SUCTION GUN WORKSHOP / 1600Z CAPACITY 21.300.001



- Includes 12" flexible hose
- Zinc plated steel head
- Heavy duty steel barrel with knurled secure grip
- Bottom zinc plated cap can be removed for easy cleaning
- Designed to remove or add gear oils to transfer cases, gearboxes or differentials



WORKSHOP SERIES

LEVER ACTION GREASE GUN 21.200.004



WORKSHOP SERIES

21.200.006



- Includes pipe and hose
- Steel barrel with knurled secure grip
- Lever with ergonomic rubber grip
- 2/3 way loading
- Accessible check valve for easy cleaning of hardened/contaminated grease
- Includes heavy duty 4 jaw coupler



PROFESSIONAL SERIES

**MOBILE AIR OPERATED OIL DISPENSER
FOR 48-55 GALLON DRUMS
PRESSURE REGULATOR WITH GAUGE**
21.500.202



- Digital oil control valve with +/- 0.5 % accuracy
- Pressure regulator with gauge
- Pulsation dampener
- Trolley constructed of heavy gauge steel with tough powder coat finish
- 8" front polyurethane wheels & 6" rear locking swivel castors
- Holds 48-58 gallon drums
- Drum clamp designed into handle
- For use with motor oils, gear oils and antifreeze
- Can be used with up to SAE 320 and gear oil up to # 630
- 21.500.200 includes 16FT oil dispensing hose
- 21.500.202 includes 50FT oil dispensing hose on a heavy duty auto retracting reel

**MOBILE AIR OPERATED OIL DISPENSER
FOR 48-55 GALLON DRUMS
PRESSURE REGULATOR WITH GAUGE**
21.500.200



PUMP SPECIFICATIONS	
AIR INLET SIZE	1/4" NPT
MAX FLOW RATE	3.2 GPM
MAX OIL FLOW	12.2 L/MIN
DISCHARGE PORT	1/2" MNPT
MIN AIR PRESSURE	43.5PSI
MAX AIR PRESSURE	116PSI
SUCTION TUBE HEIGHT	37"
RATIO	5:1
MAX OUTLET PRESSURE	218 PSI
FOR CONTAINER SIZE	55 GAL

OIL PUMP
21.700.006



DIGITAL OIL VALVE
21.700.005



- Display available in L/min or GAL/min

50' REEL WITH HOSE
21.700.002



PULSATION DAMPENER
21.700.008



WHAT'S NEW

ON PAGE 171

HYDRAULIC TOP LINK KITS WITH HOSES & Q/C TIPS

20 - 28" CATEGORY 1 HYDRAULIC TOP LINK KIT
46.120.008

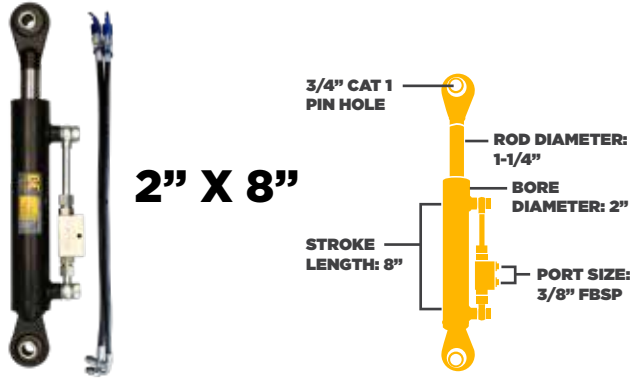

20 - 28" CATEGORY 2 HYDRAULIC TOP LINK KIT
46.220.008

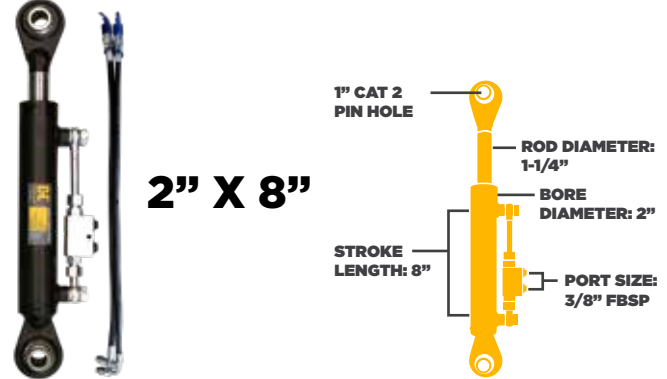

21.5 - 31.5" CATEGORY 2 HYDRAULIC TOP LINK KIT
46.225.010

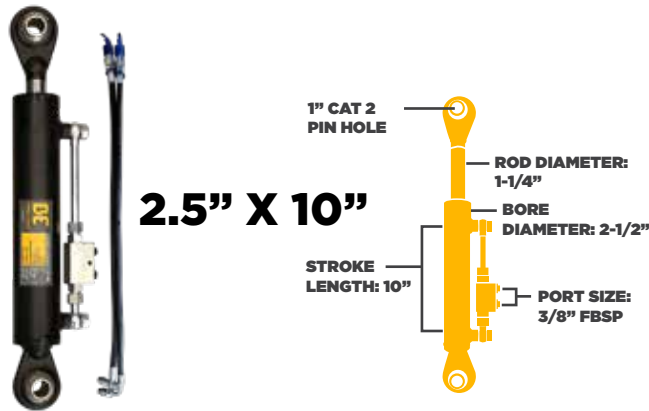

22 - 30" CATEGORY 2 HYDRAULIC TOP LINK KIT
46.230.008

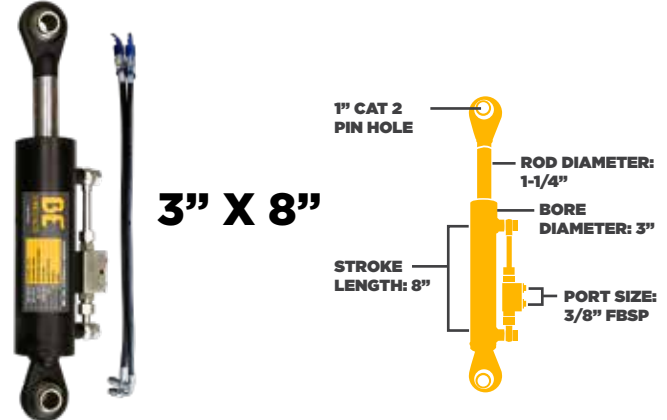

PART NUMBER	46.120.008	46.220.008	46.225.010	46.230.008
CATEGORY	1	2	2	2
COLLAPSED LENGTH	20"	20"	21.5"	22"
EXTENDED LENGTH	28"	28"	31.5"	30"
HOSE LENGTH	36"	36"	36"	36"
OPERATING PRESSURE	2,175 PSI	2,175 PSI	2,175 PSI	2,175 PSI
PUSH CAPACITY	6,490 LBS	6,490 LBS	10,300 LBS	14,600 LBS
PULL CAPACITY	3,830 LBS	3,830 LBS	7,640 LBS	10,850 LBS



HYDRAULIC TOP LINK HOSE KIT WITH Q/C TIPS
46.000.038



- 36" hose length
- 1/2" NPT thread tractor end
- 3/8" BSP thread cylinder end
- 3/8" SAE 100 2RAT hose type

**MAX PSI
4800**



HYDRAULIC FLOOR JACKS

- Built In Small Parts Tray
- Built-in safety valve protects against jack over-loading
- Hydraulic oil by-pass system protects ram from being over-extended
- "Quick Start" double pump technology for fast operation to contact point



PART NO.	35.400.102	35.400.002	35.400.035
CAPACITY	2 TON (LOW PROFILE)	2 TON	3-1/2 TON
MIN HEIGHT	2.7"	4.4"	5.2"
MAX HEIGHT	24"	20"	21"
TOTAL LIFT	21.3"	15.6"	15.8"

LONG FRAME HEAVY DUTY FLOOR JACK

- Innovative design of turbo lift offers a quick lift for professional performance
- Heavy gauge steel frame helps prevent distortion and twisting
- Safety by-pass and over-load systems protect hydraulics
- Foot pedal operated power unit
- Handle-actuated release valve provides metered control at any desired lowering speed
- Wide stance and low center of gravity provide optimum stability under load stress



PART NO.	35.410.005	65.410.010
CAPACITY	5 TON	10 TON
MINI HEIGHT	6.3"	6.3"
MAX HEIGHT	23.6"	23.6"
TOTAL LIFT	17.3"	17.3"

DOUBLE LOCK JACK STANDS

- Counter-weighted pawl serves as a safe, secure locking device to prevent the load from accidentally disengaging
- Sturdy welded-steel construction for superior safety and strength
- One piece multi-position ductile ratchet bar provides greater strength and durability
- Quick adjustment mechanism that securely locks into desired position



PART NO.	35.200.002	35.200.003	35.200.006	35.200.012
CAPACITY (PER PAIR)	2 TON	3 TON	6 TON	12 TON
BASE SIZE	7.59" X 6.88"	8.15" X 7.4"	11.22" X 9.84"	11.81" X 10.63"
MINIMUM HEIGHT	11.1"	11.8"	15.7"	17.7"
MAXIMUM HEIGHT	16.9"	17.5"	24.4"	27.5"

WHAT'S NEW

ON PAGES 269 - 274

HYDRAULIC BOTTLE JACKS

- Heat-treated extension screw allows for low pick-up height adjustment and maximum lift height
- U.S. patented built-in bypass device protects hydraulic system from overpumping damage
- Unique cross-type forged release valve assures positive control
- Wide rugged base provides stability and strength
- In-line pump allows for easy jack positioning under load



PART NO.	35.300.002	35.300.004	35.300.006	35.300.008	35.300.012	35.300.112	35.300.020
CAPACITY	2 TON	4 TON	6 TON	8 TON	12 TON	12 TON SHORTY	20 TON
LIFTING	4.5"	4.6"	5"	5.8"	5.9"	3.9"	5.3"
ADJUST	2"	2.4"	2.7"	3.1"	3.1"	2.4"	2.3"
MIN. HEIGHT	7.1"	7.6"	8.5"	9.1"	9.4"	7.5"	9.5"
MAX. HEIGHT	13.6"	14.6"	16.2"	18"	18.4"	13.8"	17.1"

MOTORCYCLE / ATV JACK

- Swivel rear heavy duty castor wheels
- Heavy duty Steel Construction provides stability and rigidity
- Non-slip pedal provides easy lifting operation
- Rubber padded lifting platform protects object from scratching



PART NO.	35.001.500
CAPACITY	1,500 LB
LIFTING	9.9"
MIN. HEIGHT	4.6"
MAX. HEIGHT	14.5"

PORTABLE POWER BODY REPAIR KITS

- Cases are portable for easy use in shop or on the road
- Custom fitted, rugged, blow-molded storage case
- 10 ton set has wheels for easy movement
- A must for body collision repair use
- Designed for applications of pushing, spreading and pressing of vehicle body panels as well as various component parts and assemblies
- A variety of attachments are included
- Pumps are rated from 8,000 to 10,000 PSI



PART NO.	35.100.004	35.100.010
CAPACITY	4 TON	10 TON

TRUE CATEGORY 1 QUICK HITCH QH1N



SOLID FORGED 3/8" BUCKET HOOK SET BOLT-ON / WELD-ON 64.500.700



PART#	SIZE	GRADE	WLL
64.500.700*	3/8"	G70	6600 LB
64.500.701**	3/8"	G70	6600 LB

* RETAIL FRIENDLY BLISTER PACK

** BULK CARTON PACKAGING

REAR WEIGHT BOX 3.67 FT³ / 550 LB CAPACITY BE-RWB1



FILL GUIDE	
FILL TYPE	WEIGHT PER FT ³
CONCRETE	150 LBS
GRAVEL	110 LBS
SAND	100 LBS

PART #	BE-RWB1
HITCH	CAT 1
BOX VOLUME	3.67 FT ³
CAPACITY (WITH BOX)	575 LBS
CAPACITY (FILL ONLY)	550 LBS
QUICK HITCH COMPATIBLE	YES
SHIPPING WEIGHT	104 LBS
OVERALL DIMENSIONS	26-1/8" X 13-7/8" X 28-3/4"

UNIVERSAL BUCKET ACCESSORY PLATE 64.500.705



64.500.705

GRADE 8 HARDWARE INCLUDED



JOHN DEERE BUCKET ACCESSORY PLATE 64.500.705G



64.500.705G

PART#	HOOK SIZE	GRADE	WLL	D RINGS	RECEIVER SIZE	HITCH PIN HOLE SIZE	MOUNT	PLATE DIMENSIONS
64.500.705	5/16"	G70	4700 LB	1/2"	2"	5/8"	UNIVERSAL	22" X 4-3/8" X 1/4"
64.500.705G*	5/16"	G70	4700 LB	1/2"	2"	5/8"	JOHN DEERE	22" X 6" X 1/4"

* 64.500.705G FITS JOHN DEERE STYLE BUCKETS: 53", 57", 57"HD, 61", & 73"

FEATURED ITEMS!

SPECIAL PRICING ON FAST MOVING ITEMS

LOAD BINDERS

5/16" - 3/8" WLL 5400 LB
64.100.002



RATCHET LOAD BINDER

5/16" - 3/8" WLL 5400 LB
64.199.002



FOLDING HANDLE LOAD BINDER

64.198.002



CHAIN SIZE		WLL
(G70)	(G43)	
5/16"	3/8"	5400

LOAD BINDER SECURING BRACKET

64.100.004



CABLE TYPE BINDER LOCK

64.100.104



POST POUNDER

71.004.002 AVAILABLE ONLY IN CANADA

71.004.002R AVAILABLE ONLY IN USA



CLEVIS SLIP HOOK W/LATCH G70

1/4" 64.110.006

5/16" 64.110.007

3/8" 64.110.008



G70 CHAIN ASSEMBLIES

5/16" X 16' 64.016.516

5/16" X 20' 64.020.516

3/8" X 16' 64.016.038

3/8" X 20' 64.020.038



GRAB HOOK G70

1/4" 64.100.009

3/8" 64.100.010

5/16" 64.100.011



EURO TRACTOR ATTACHMENT WELD-ON MOUNTING BRACKETS WOKAO600



2" DROP TRAILER BALL MOUNT 64.500.320



2" TRAILER BALL 1" EXTERNAL THREAD 64.500.350



SPECIAL PRICING WHILE QUANTITIES LAST

AIR COMPRESSOR JUMP STARTER

67.999.474



- 12V/24V
- 500A Cranking Amp/1200A Peak Amp
- 20Ah Sealed lead-acid battery
- Air compressor
- X 12V Power outlet
- Built in high brightness LED work light
- On/Off Switch for safety
- Automatic circuit overload protection
- Reverse hook-up alarm and indication
- USB port



LITHIUM-ION DELUXE ROLL & SPRAY

PART# 90.709.030

- Battery: lithium-ion technology
- Input: 18V, 2.2 Ah
- Liquid flow: 2.4 L/min
- Spray distance: > 10m
- Work time: 45-65 min
- Charge time: 2.5 Hours



PORTABLE SAFETY LIGHT BATTERY OPERATED

LS001

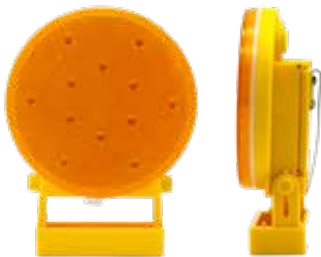

FLOOD LIGHT - 17 EPISTAR LEDS

LF5101

51W

3825 LUMENS



PORTABLE FLOOD LIGHT - 5 EPISTAR LEDS

LF1501

15W

1125 LUMENS



LEATHER PALM GLOVES SIZE - LARGE

67.999.100



LEVER ACTION GREASE GUN DEVELOPS 10,000 PSI

67.211.000



SUPER HEAVY DUTY LEVER ACTION GREASE GUN DEVELOPS 10,000 PSI

67.111.110



12" GREASE GUN HOSE WITH HD COUPLER

67.000.010



OVERSTOCK!

SPECIAL PRICING WHILE QUANTITIES LAST

EYE WEAR
CLEAR LENS, CLEAR FRAME
20 PACK
1209C



EYE WEAR
MIRROR LENS, BLACK FRAME
20 PACK
1209B



GALVANIZED AIRCRAFT CABLE
3/32" X 500' ROLL
64.424.999



200' HOSE REEL
85.410.020



HOSE REEL WITH
NEW SPRING
LOCKING MECHANISM



400' HOSE REEL
85.410.040



HOSE REEL WITH
NEW SPRING
LOCKING MECHANISM



200' MANUAL HOSE REEL
85.401.020



400' MANUAL HOSE REEL
85.401.040



WALTERSCHEID TYPE WWE PTO (CV 1 END)
WWE W2480 TYPE WIDE ANGLE 80° 540 QD YOLKS
CV ASSEMBLY 1 SIDE. 64" OAL, COLLAPSED, 53 HP
69.999.001



UNIVERSAL WRAP SEAT

SEA-50DIBE

- Industrial wrap
- Fore/aft adjustable
- Document pocket in seat back
- Black

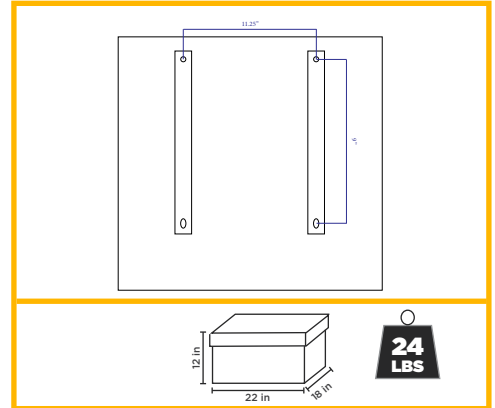

UNIVERSAL WRAP SUSPENSION SEAT

SEA-509SDIBE

- Industrial Wrap
- Adjustable back rest
- Fore/aft adjustable
- Weight adjustable suspension
- Document pocket in seat back
- Black

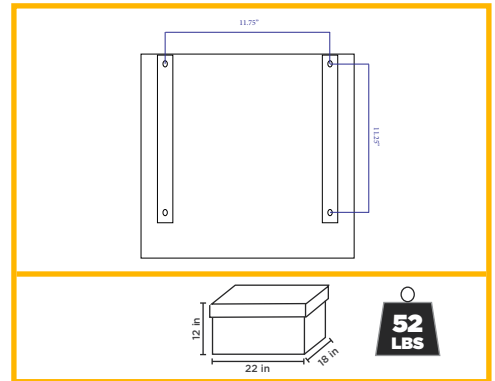

UNIVERSAL NON SUSPENSION SEAT

SEA-508BE

- Leatherette upholstery
- Non-suspension
- Includes slide track
- Black

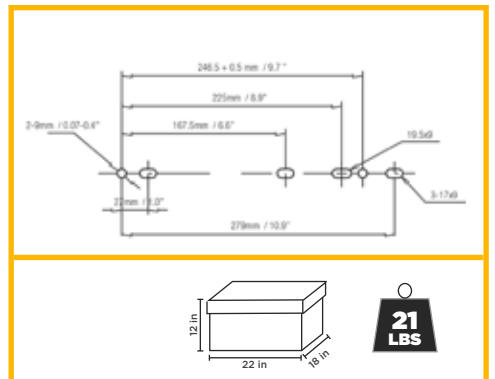

BLACK UNIVERSAL SUSPENSION SEAT

SEA-12USSBE

- Leatherette upholstery
- Fore/aft adjustment
- Weight adjustable suspension
- Black

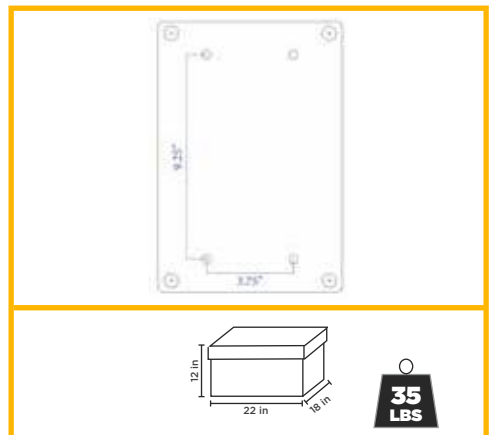

OVERSTOCK!

SPECIAL PRICING WHILE QUANTITIES LAST

UNIVERSAL SLIDE SEAT SEA-8WSBE

- PVC cover
- Non-suspension
- Includes slide track

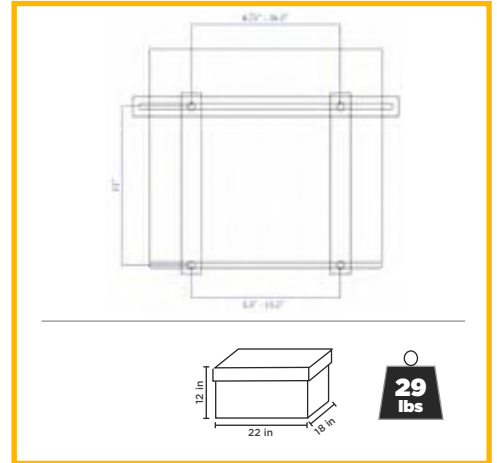

LOW BACK PAN SEAT SEA-7PNBE

- Steel pan frame
- Waterproof
- Includes drain holes
- Black

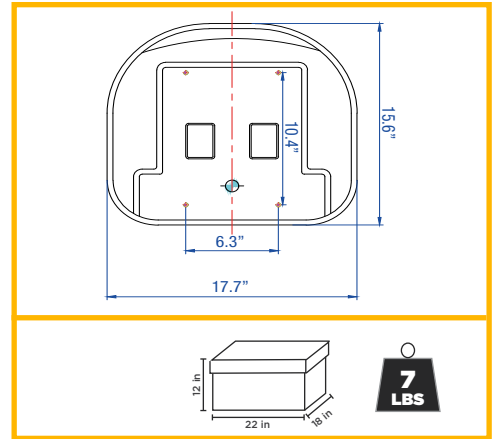

UNIVERSAL INDUSTRIAL SUSPENSION SEAT SEA-SU35500BE

- Leatherette upholstery
- Folding seat back
- Fore/aft adjustable
- Weight adjustable suspension
- Black

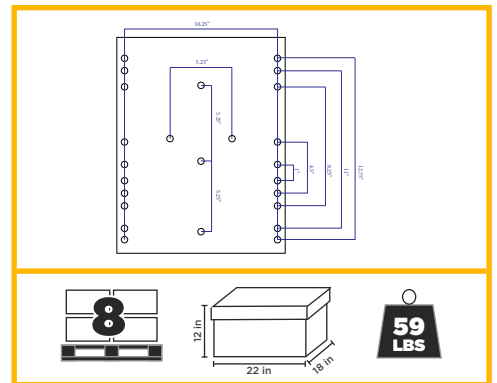

UNIVERSAL INDUSTRIAL SUSPENSION SEAT SEA-SHA35500BE

- Moulded vinyl cushion
- Swivel for entry/exit
- Folding seat back and armrest
- Mechanical suspension
- Black

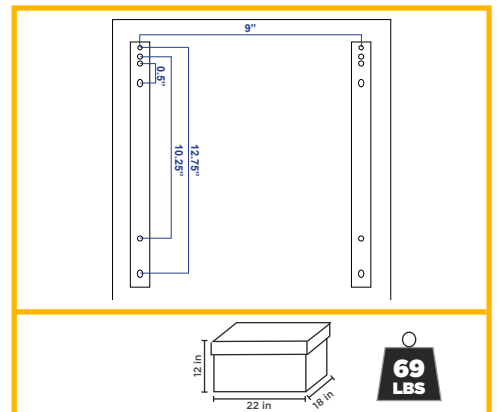

PTO DRIVELINES

PTO PLAN-O-GRAM
POP-PTO4



**DESIGNED TO WORK WITH
STANDARD LOZIER SHELVING UNITS**
COLOR CODING AND ALPHABETICAL SYSTEM
SIMPLIFIES & MAKES PROGRAM
CONSUMER FRIENDLY

**CONTACT US TODAY
FOR INFORMATION AND PRICING ON OUR
PTO PROGRAM.**
RECEIVE THE MERCHANDISERS FREE WITH THE
PURCHASE OF THE COMPLETE PROGRAM.

PTO DISPLAY STAND
69.000.000



PTO - BOXED

PART#	DESCRIPTION	BEST USE	HP	SERIES
69.885.001	PTO, BY-PY #1 25" 540 QD X 2 C-C	FERTILIZER SPREADERS	16 HP	1
69.885.260	PTO, BY-PY#2 52" 540 QD X 1.25 C-C	POST HOLE DIGGERS	21 HP	2
69.885.049	PTO, #4 25" 540 X 1-3/8 RB C-C	ROTARY CUTTERS	35 HP	4
69.885.051	PTO, #4 52" 540 X 1-3/8 RB C-C	ROTARY CUTTERS	35 HP	4
69.885.004	PTO, BY-PY #4 34" 540 QD X 2 C-C	LIGHT DUTY MOWERS , TILLERS, ROTARY CUTTERS	35 HP	4
69.885.456	PTO, BY-PY #4 48" 540 QD X 2 C-C	LIGHT DUTY MOWERS , TILLERS, ROTARY CUTTERS	35 HP	4
69.885.005	PTO,#5 540 SB CLUTCH X 540 C-C	SNOWBLOWERS, TILLERS	47 HP	5
69.885.664	PTO, BY-PY #6 57" 540 QD X 2 C-C	FLAIL MOWERS	64 HP	6



PTOS - GENERAL PURPOSE

PART#	DESCRIPTION	BEST USE	HP	SERIES
69.888.001	BY-PY #1 540 QD X 2, 34" C-C QD PIN	GENERAL PURPOSE	16 HP	1
69.888.002	BY-PY #2 540 QD X 2, 34" C-C QD PIN	GENERAL PURPOSE	21 HP	2
69.888.006	BY-PY #6 540 QD X 2, 34" C-C QD PIN	GENERAL PURPOSE	64 HP	6
69.575.356	BY-PY #6 540 X 1000 QTD, 34" C-C QD PIN	GENERAL PURPOSE	64 HP	6
69.888.007	BY-PY #7 540 QD X 2, 34" C-C QD PIN	GENERAL PURPOSE	75 HP	7
69.888.008	BY-PY #8 540 QD X 2, 34" C-C QD PIN	GENERAL PURPOSE	95 HP	8



WALTERSCHEID TYPE CROSS KITS - BOXED

PART#	DESCRIPTION	SERIES
10-01-00	CROSS KIT, 22 MM X 55 MM, 16 HP	W2100
35-00-00	CROSS KIT, 32 MM X 76 MM, 53 HP	W2400
36-00-00	CROSS KIT, 36 MM X 89 MM, 90 HP	W2500



BY-PY TYPE CROSS KITS - BOXED

PART#	DESCRIPTION	SERIES
71201	CROSS KIT, 22 MM X 54.8 MM, 16 HP	1
71202	CROSS KIT, 23.8 MM X 61.3 MM, 21 HP	2
71203	CROSS KIT, 27 MM X 70 MM, 30 HP	3
71204	CROSS KIT, 27 MM X 74.5 MM, 35 HP	4
71205	CROSS KIT, 30.2 MM X 80 MM, 47 HP	5
71206	CROSS KIT, 30.2 MM X 92 MM, 64 HP	6
71207	CROSS KIT, 35 MM X 94 MM, 75 HP	7
71208	CROSS KIT, 35 MM X 106.3 MM, 95 HP	8



NORTH AMERICAN IMPERIAL CROSS KITS

PART#	DESCRIPTION	SERIES
200-06	CROSS KIT, .97" X 2.28", 20 HP	6N
200-12	CROSS KIT, 1.06" X 2.50", 30 HP	12N
200-14	CROSS KIT, 1.13" X 2.62", 50 HP	14N
200-35	CROSS KIT, 1.25" X 3.20", 80 HP	35N



YOKE

PART#	DESCRIPTION	SERIES
507010351P	YOKE, #1 1-3/8" 6 QD PIN	1
507020351P	YOKE, #2 1-3/8" 6 QD PIN	2
211029151	YOKE, #2 SHEAR BOLT 1-1/4"	2
21-10-00P	YOKE, #4 1-3/8" 6 SP QD PIN	4
21-24-151	YOKE, #4 1-3/8" 1/2" BOLT	4
507050351P	YOKE, #5 1-3/8" 6 SP QD PIN	5
606505001	CLUTCH, #5 1-3/8" 6 S/BOLT	5
22-10-00P	YOKE, #6 1-3/8" 6 SP QD PIN	6



BY-PY STANDARD PTOS

PART#	DESCRIPTION	BEST USE	HP	SERIES
69.888.264	BY-PY #2 540 QD X 2, 57" C-C	GENERAL PURPOSE	21 HP	2
69.888.464	BY-PY #4 540 QD X 2, 52" C-C	GENERAL PURPOSE	35 HP	4



BY-PY RADIAL PTOS

PART#	DESCRIPTION	BEST USE	HP	SERIES
69.888.013HD	BY-PY #4 540 QD X RADIAL PIN CLUTCH 800 NM 1500 MM C-C	ROTARY RAKES	35 HP	4



BY-PY ROUND BORE SHEAR BOLT PTOS

PART#	DESCRIPTION	BEST USE	HP	SERIES
69.888.049	BY-PY #4 QD 540 X 1-3/8" RB, 1/2" SHEAR BOLT, 34" C-C	SMOOTH BORE ROTARY CUTTERS	35 HP	4
69.777.053	BY-PY #4 QD 540 X 1-1/4" RB, 3/8" BOLT HOLE, 52" C-C	POST HOLE AUGERS WITH 1 1/4" SHAFT	35 HP	4
69.888.059	BY-PY #5 QD 540 X 1-3/8" RB, 1/2" SHEAR BOLT, 43" C-C	COMMON 6' ROTARY CUTTERS	47 HP	5
69.888.069	BY-PY #6 QD 540 QD X 1-3/8 RB 1/2" BOLT HOLE, 41" OAL	HD BRUSH CUTTERS. 6' TO 7'	64 HP	6



BY-PY SHEAR BOLT PTOS

PART#	DESCRIPTION	BEST USE	HP	SERIES
69.888.400	BY-PY #4 540 QD X 2, 34" C-C SHEAR BOLT CLUTCH 1700 NM*	540 ROTARY CUTTERS LIGHT TILLERS	35 HP	4
69.750.006	BY-PY #6 540 SB SHEAR BOLT CLUTCH, 41" OAL	540 BRUSH CUTTERS MEDIUM TILLERS	64 HP	6
69.888.046	BY-PY #8 540 QD X SB TORQUE LIMIT SHEAR BOLT CLUTCH, 34" C-C	MEDIUM/HD TILLERS & SNOW BLOWERS	95 HP	8



BY-PY OVERRUNNING PTOS

PART#	DESCRIPTION	BEST USE	HP	SERIES
69.888.011	BY-PY #5 34" C-C 540 X OVR OVER RUNNING CLUTCH	ROTARY RAKES	47 HP	5



WALTERSCHEID TYPE STANDARD PTOS

PART#	DESCRIPTION
69.000.010	W2500 SERIES 44" 540 QD X 2 90 HP HD STAR SHAFTING
69.000.018	W2500 1500 MM EXTRA LONG NO END YOLKS, 66" OAL

OAL = OVERALL LENGTH COLLAPSED
C-C = INNER CROSS TO INNER CROSS LENGTH COLLAPSED

REPLACEMENT
END YOKES
AVAILABLE

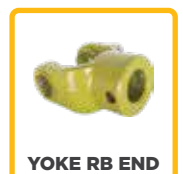

PTO DRIVELINES



WALTERSCHEID TYPE WWE PTOS (CV 1 END)

PART#	DESCRIPTION
69.000.035	WWE 2380 WIDE ANGLE 80° 540 RPM ONE END, 34" C-C, 38 HP
69.000.042	WWE 2580 WIDE ANGLE 80° 540 QD BOTH ENDS, 34" C-C, 90 HP
69.000.033	WWE 2580 WIDE ANGLE 80° 1-3/4 20 SPLINE BOTH ENDS 540 QD BOTH ENDS, 48" C-C, 90 HP
69.999.001	WWE W2480 TYPE WIDE ANGLE 80° 540 QD YOLKS CV ASSEMBLY 1 SIDE, 64" OAL COLLAPSED, 53 HP



WALTERSCHEID TYPE WWZ PTOS (CV BOTH ENDS)

PART#	DESCRIPTION
69.000.034	WWZ 2380 WIDE ANGLE 80° BOTH ENDS, 34" C-C, 38 HP 540 GENERAL PURPOSE DOUBLE CV
69.999.002	WWZ W2480 TYPE WIDE ANGLE 80° 540 QD YOKES, CV ASSEMBLY BOTH SIDES, 44" OAL COLLAPSED, 53 HP



WALTERSCHEID TYPE SLIP & CAM CLUTCH PTOS

PART#	DESCRIPTION
69.000.047	W2500 860 MM 1-3/8 6 W/4 PLATE FRICTION DISC CLUTCH, 44" OAL



PTOS - SPECIALTY APPLICATIONS

PART#	DESCRIPTION	BEST USE	HP
69.777.260	BY-PY #2 QD 540 X 1-1/4" RB, 52" C-C	POST HOLE AUGERS	21 HP
69.777.550	BY-PY #5 540 QD X 4 PLATE 540 HD, 42" OAL	540 BRUSH CUTTERS TILLERS	47 HP



COMPLETE SLIP CLUTCH & PTO!
SEE BELOW FOR DETAILS

ADJ FRICTION
DISC CLUTCH

PTOS - SPECIALTY APPLICATIONS

PART#	DESCRIPTION	BEST USE	HP
69.777.039	BY-PY #6 540 QD X 2, 40" OAL, 2 PLATE ADJ SLIP CLUTCH	540 MEDIUM TILLERS. 2 PLATE	64 HP
69.888.040	BY-PY #6 540 QD X 2, 42" OAL, 4 PLATE ADJ SLIP CLUTCH	540 MEDIUM DUTY TILLERS.	64 HP

OAL = OVERALL LENGTH COLLAPSED
C-C = INNER CROSS TO INNER CROSS LENGTH COLLAPSED

SLIP CLUTCHES

UNIVERSAL 2 PLATE SLIP CLUTCH
1-3/8" 540 MALE - 1-3/8", 540 FEMALE
 69.000.100



UNIVERSAL 2 PLATE SLIP CLUTCH
1-3/8" RB FEMALE - 1-3/8", RB MALE
 69.000.101



UNIVERSAL 2 PLATE SLIP CLUTCH
1-3/8" RB FEMALE - 1-3/8" 540 MALE
 69.000.102



BE REPLACEMENT PTO SHIELDS ASSEMBLIES

NEW STYLE

69.888.996	SERIES 1 - 4
69.888.997	SERIES 5 - 8



PTO SHIELDS COME COMPLETE WITH INNER AND OUTER SHIELDINGS, BELL CONES, ALL BRG'S AND SAFETY CHAIN

1/2" X 3-1/2" SHEAR BOLT KIT WITH LOCK NUT
 67.000.005



QUICK DISCONNECT YOKE PIN KIT
 401000001



QD YOKE PIN KIT

PART#	W	L	A	B
401000001	76.5	14	9	24

*DIMENSIONS IN MM

540 MALE INTERMEDIATE SHAFT
540 X 540 HARDENED ENDS
 90.100.995



PTO ADAPTER
1-3/8" FEMALE - 1-3/8" X 6 MALE
 500PA

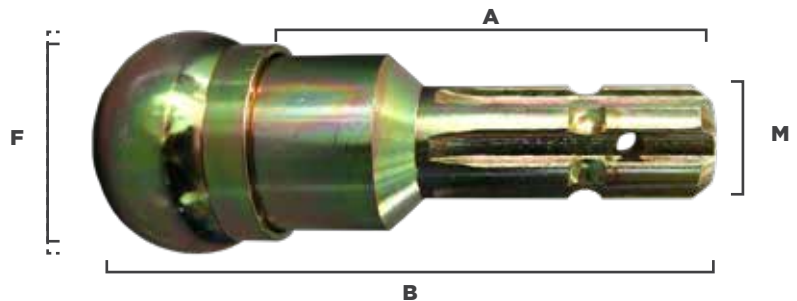

PTO ADAPTERS

PART#	REPLACEMENT PIN	A INCREASE SHAFT LENGTH	B OVERALL LENGTH	M SPLINE MALE	F QD SPLINE FEMALE
500PA	500P	4-1/8"	7-1/4"	1-3/8" X 6	1-3/8" X 6
501PA	500P	4-1/4"	7-1/4"	1-3/8" X 6	1-3/8" X 21
502PA	500P	4-1/2"	7-1/4"	1-3/8" X 21	1-3/8" X 6
503PA	500P	4-1/2"	7-1/4"	1-3/8" X 21	1-3/8" X 21

PTO EXTENDER

1-3/8" FEMALE QUICK DISCONNECT - 1-3/8" X 6 SPLINE

508PA

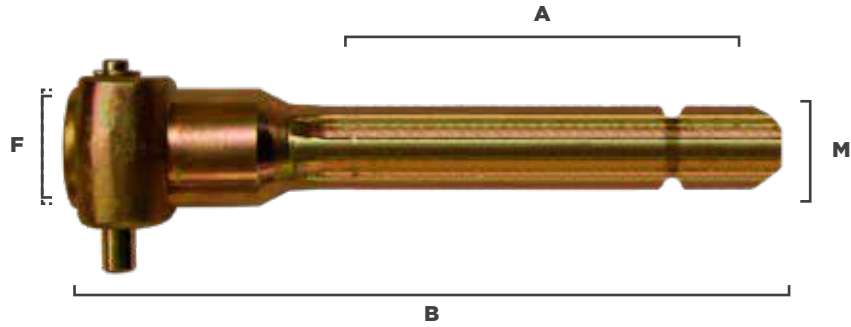

PTO EXTENDER

PART#	A INCREASE SHAFT LENGTH	B OVERALL LENGTH	M SPLINE MALE	F QD SPLINE FEMALE
508PA	8"	11-1/4"	1-3/8" X 6	1-3/8" X 6

PTO ADAPTER

1-3/8" FEMALE - 1-1/8" X 6 MALE

550PA

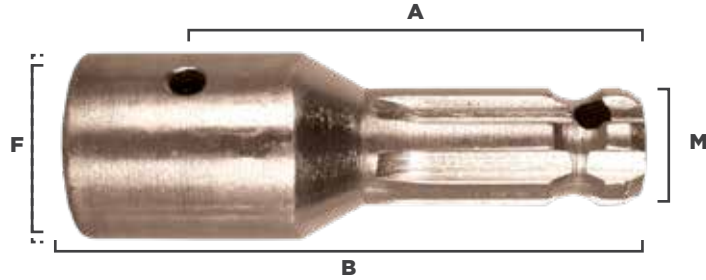

PTO ADAPTERS

PART#	ROLL PIN	A INCREASE SHAFT LENGTH	B OVERALL LENGTH	M SPLINE MALE	F QD SPLINE FEMALE
550PA	11/32"	2-1/2"	5-3/8"	1-1/8" X 6	1-3/8" X 6
551PA	11/32"	2-1/2"	4-3/4"	1-3/8" X 6	1-1/8" X 6
552PA	11/32"	1-1/8"	3-3/16"	1-3/8" X 6	1-1/8" X 6
553PA	11/32"	4"	5-3/4"	1-3/8" X 6	1-3/8" X 6
555PA	11/32"	3-7/8"	4-13/16"	1-3/8" X 6	30 MM ROUND (SMOOTH)

PTO ADAPTER

1-3/4" X 20 FEMALE - 1-3/8" X 21 MALE

580PA

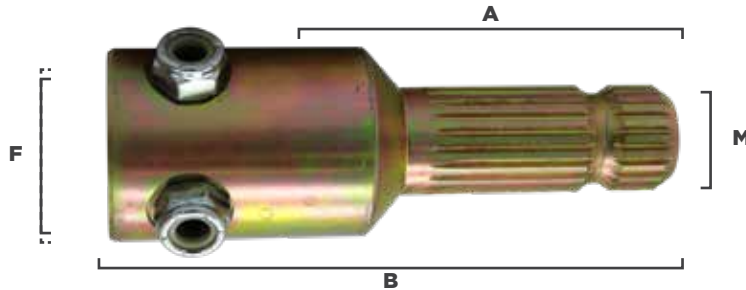

PTO ADAPTERS

PART#	TYPE	A INCREASE SHAFT LENGTH	B OVERALL LENGTH	M SPLINE MALE	F SPLINE FEMALE
580PA	CLAMP ON	5-1/2"	7-1/8"	1-3/8" X 21	1-3/4" X 20
581PA	CLAMP ON	5-1/2"	7-1/8"	1-3/8" X 6	1-3/4" X 20

PTO ADAPTERS

OVERRUNNING CLUTCH

1-3/8" M X 1-1/8" F

585PA



1-3/8" M X 1-3/8" F

586PA

PTO OVERRUNNING CLUTCH

540 X 540

587PA

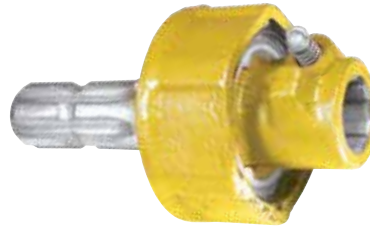

REDUCING INSERT

1-3/8" - 1-1/8" LONG

600PA



1-3/8" - 1-1/8" SHORT

601PA

PTO ADAPTER

1-3/8" X 5/8" 6 SPLINE FEMALE

602PA

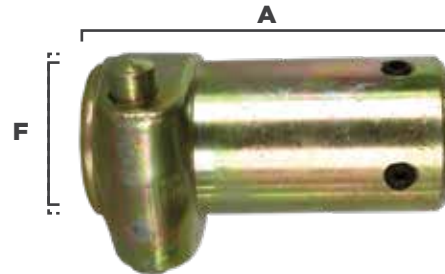

PTO ADAPTERS

PART#	KEY	REPLACEMENT PIN	A	F FEMALE
602PA	3/16"	610PA	4-11/32"	1-3/8" X 5/8" 6 SPLINE
603PA	3/16"	610PA	4-11/32"	1-3/8" X 3/4" 6 SPLINE
604PA	3/16"	610PA	4-11/32"	1-3/8" X 7/8" 6 SPLINE
605PA	1/4"	610PA	4-11/32"	1-3/8" X 15/16" 6 SPLINE
606PA	1/4"	610PA	4-11/32"	1-3/8" X 1" 6 SPLINE
607PA	1/4"	610PA	4-11/32"	1-3/8" X 1-1/8" 6 SPLINE

PTO ADAPTER

1-3/8" X 6 SPLINE FEMALE - 7/8" MALE

PD-225

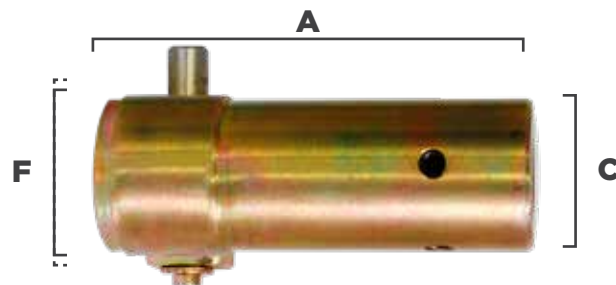

PTO ADAPTER

PART#	KEY	A OVERALL LENGTH	M SPLINE MALE	F SPLINE FEMALE
PD-225	1/4"	5-1/8"	7/8"	1-3/8" X 6

ROTARY CUTTER GEARBOX

RC25.4G

MACHINE TYPE	4' ROTARY CUTTER SQUARE BODY	OUTPUT SHAFT (#1) SIZE	1-1/2"
HP RATING	50 HP	OUTPUT SHAFT (#1) TYPE	12 SPLINE
GEAR RATIO	1:1.93	OUTPUT SHAFT (#2) SIZE	N/A
INPUT SHAFT SIZE	1-3/8"	OUTPUT SHAFT (#2) TYPE	N/A
INPUT SHAFT TYPE	ROUND	MOUNTING PATTERN	4 BOLT PATTERN (5/8"), 4-3/4" SPACING



ROTARY CUTTER GEARBOX

RC25.4G-RB

MACHINE TYPE	4' ROTARY CUTTER ROUND BODY	OUTPUT SHAFT (#1) SIZE	1-1/2"
HP RATING	50 HP	OUTPUT SHAFT (#1) TYPE	12 SPLINE
GEAR RATIO	1:1.93	OUTPUT SHAFT (#2) SIZE	N/A
INPUT SHAFT SIZE	1-3/8"	OUTPUT SHAFT (#2) TYPE	N/A
INPUT SHAFT TYPE	ROUND	MOUNTING PATTERN	4 BOLT PATTERN (5/8"), 4-3/4" SPACING



ROTARY CUTTER GEARBOX

RC25.5G

MACHINE TYPE	5-6' ROTARY CUTTER SQUARE BODY	OUTPUT SHAFT (#1) SIZE	1-1/2"
HP RATING	50 HP	OUTPUT SHAFT (#1) TYPE	12 SPLINE
GEAR RATIO	1:1.46	OUTPUT SHAFT (#2) SIZE	N/A
INPUT SHAFT SIZE	1-3/8"	OUTPUT SHAFT (#2) TYPE	N/A
INPUT SHAFT TYPE	ROUND	MOUNTING PATTERN	4 BOLT PATTERN (3/4"), 4-3/4" SPACING



ROTARY CUTTER GEARBOX

RC25.5G-RB

MACHINE TYPE	5-6' ROTARY CUTTER ROUND BODY	OUTPUT SHAFT (#1) SIZE	1-1/2"
HP RATING	50 HP	OUTPUT SHAFT (#1) TYPE	12 SPLINE
GEAR RATIO	1:1.46	OUTPUT SHAFT (#2) SIZE	N/A
INPUT SHAFT SIZE	1-3/8"	OUTPUT SHAFT (#2) TYPE	N/A
INPUT SHAFT TYPE	ROUND	MOUNTING PATTERN	4 BOLT PATTERN (3/4"), 4-3/4" SPACING



ROTARY CUTTER GEARBOX

RC25.5.540G

MACHINE TYPE	5-6' ROTARY CUTTER SQUARE BODY	OUTPUT SHAFT (#1) SIZE	1-1/2"
HP RATING	50 HP	OUTPUT SHAFT (#1) TYPE	12 SPLINE
GEAR RATIO	1:1.46	OUTPUT SHAFT (#2) SIZE	N/A
INPUT SHAFT SIZE	1-3/8"	OUTPUT SHAFT (#2) TYPE	N/A
INPUT SHAFT TYPE	6 SPLINE	MOUNTING PATTERN	4 BOLT PATTERN (3/4"), 4-3/4" SPACING



ROTARY CUTTER GEARBOX

RC25.5.540G-RB

MACHINE TYPE	5-6' ROTARY CUTTER ROUND BODY	OUTPUT SHAFT (#1) SIZE	1-1/2"
HP RATING	50 HP	OUTPUT SHAFT (#1) TYPE	12 SPLINE
GEAR RATIO	1:1.46	OUTPUT SHAFT (#2) SIZE	N/A
INPUT SHAFT SIZE	1-3/8"	OUTPUT SHAFT (#2) TYPE	N/A
INPUT SHAFT TYPE	6 SPLINE	MOUNTING PATTERN	4 BOLT PATTERN (3/4"), 4-3/4" SPACING



HEAVY DUTY ROTARY CUTTER GEARBOX

RC25.6HDG

MACHINE TYPE	6' HEAVY DUTY ROTARY CUTTER	OUTPUT SHAFT (#1) SIZE	2"
HP RATING	70 HP	OUTPUT SHAFT (#1) TYPE	15 SPLINE
GEAR RATIO	1:1.46	OUTPUT SHAFT (#2) SIZE	N/A
INPUT SHAFT SIZE	1-3/8"	OUTPUT SHAFT (#2) TYPE	N/A
INPUT SHAFT TYPE	6 SPLINE	MOUNTING PATTERN	4 BOLT PATTERN(1"), 6" SPACING



POST HOLE DIGGER GEARBOX

PHDG4

MACHINE TYPE	POST HOLE DIGGER	OUTPUT SHAFT (#1) SIZE	2"
HP RATING	40 HP	OUTPUT SHAFT (#1) TYPE	ROUND
GEAR RATIO	2.92:1	OUTPUT SHAFT (#2) SIZE	N/A
INPUT SHAFT SIZE	1-1/4"	OUTPUT SHAFT (#2) TYPE	N/A
INPUT SHAFT TYPE	ROUND	MOUNTING PATTERN	STEPPED PIN 7/8" X 3/4" X 7"



FERTILIZER SPREADER GEARBOX

PFS45G

MACHINE TYPE	FERTILIZER SPREADER (SPIN TYPE)	OUTPUT SHAFT (#1) SIZE	1"
HP RATING	40 HP	OUTPUT SHAFT (#1) TYPE	ROUND
GEAR RATIO	1:1	OUTPUT SHAFT (#2) SIZE	N/A
INPUT SHAFT SIZE	1-3/8"	OUTPUT SHAFT (#2) TYPE	N/A
INPUT SHAFT TYPE	6 SPLINE	MOUNTING PATTERN	2 BOLT PATTERN (10 MM), 80 MM SPACING



FERTILIZER SPREADER GEARBOX

PFS45G-L

MACHINE TYPE	FERTILIZER SPREADER (SPIN TYPE)	OUTPUT SHAFT (#1) SIZE	1"
HP RATING	40 HP	OUTPUT SHAFT (#1) TYPE	ROUND
GEAR RATIO	1:1	OUTPUT SHAFT (#2) SIZE	N/A
INPUT SHAFT SIZE	1-3/8"	OUTPUT SHAFT (#2) TYPE	N/A
INPUT SHAFT TYPE	6 SPLINE	MOUNTING PATTERN	2 BOLT PATTERN (10 MM), 80 MM SPACING



SNOWBLOWER GEARBOX

SBSN57-2015G

MACHINE TYPE	SNOWBLOWER	OUTPUT SHAFT (#1) SIZE	1-1/4" (FAN)
HP RATING	53 HP	OUTPUT SHAFT (#1) TYPE	ROUND (FAN)
GEAR RATIO	1:1.46	OUTPUT SHAFT (#2) SIZE	1.24" (AUGER)
INPUT SHAFT SIZE	1-3/8"	OUTPUT SHAFT (#2) TYPE	19 SPLINE (AUGER)
INPUT SHAFT TYPE	6 SPLINE	MOUNTING PATTERN	4 BOLT PATTERN (7/16"), 4-1/4" SPACING



ALL BECO TRACTOR SEATS COME FULLY PACKAGED IN HIGH QUALITY RETAIL BOXES



EXTRA THICK CARDBOARD FOR A DURABLE, LONG LASTING BOX

COLOR & NUMBERING SYSTEM TO MAKE FINDING THE RIGHT SEAT EASY

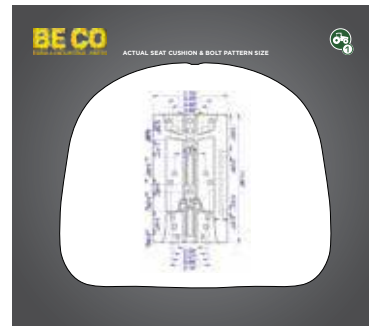

ACTUAL SIZE SEAT CUSHION & DETAILED BOLT PATTERN ON THE LID OF THE BOX



UNIVERSAL SUSPENSION SEAT

SEA-300RMBE

- Leatherette upholstery
- Steel frame
- Molded cushion
- Adjustable with 5 mounting angles
- Fore/aft adjustment
- Weight adjustable suspension
- Includes mounting plate
- Includes slide track
- Black

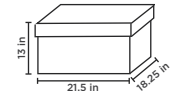
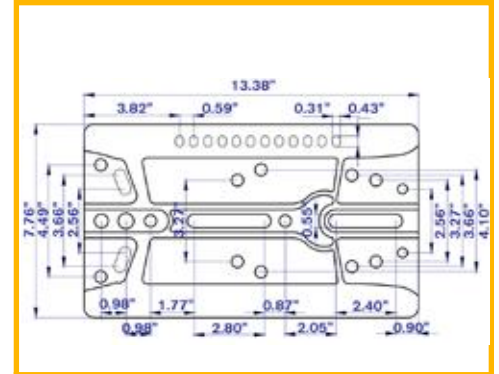

UNIVERSAL SUSPENSION SEAT

SEA-300RMBLUBE

- Leatherette upholstery
- Steel frame
- Molded cushion
- Adjustable with 5 mounting angles
- Fore/aft adjustment
- Weight adjustable suspension
- Includes mounting plate
- Includes slide track
- Blue

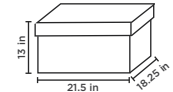
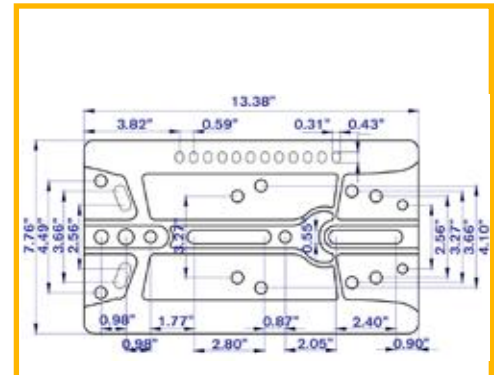
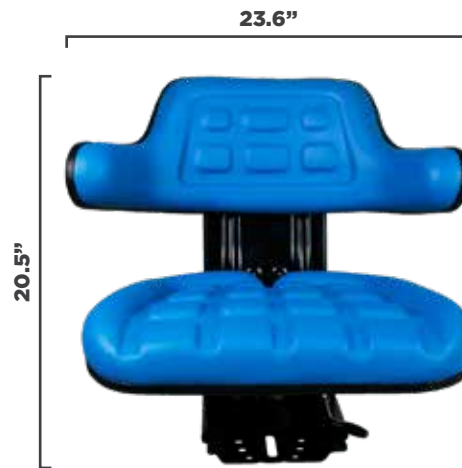

UNIVERSAL SUSPENSION SEAT

SEA-300RMYEBE

- Leatherette upholstery
- Steel frame
- Molded cushion
- Adjustable with 5 mounting Angles
- Fore/aft adjustment
- Weight adjustable suspension
- Includes mounting plate
- Includes slide track
- Yellow

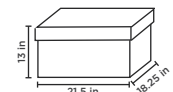
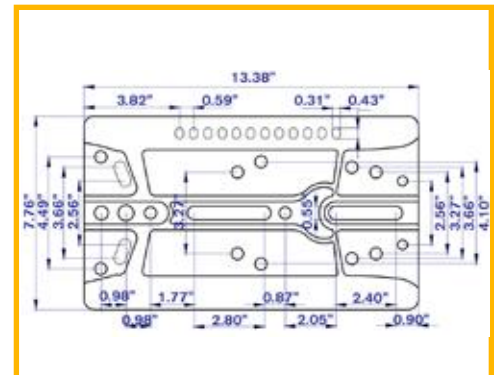
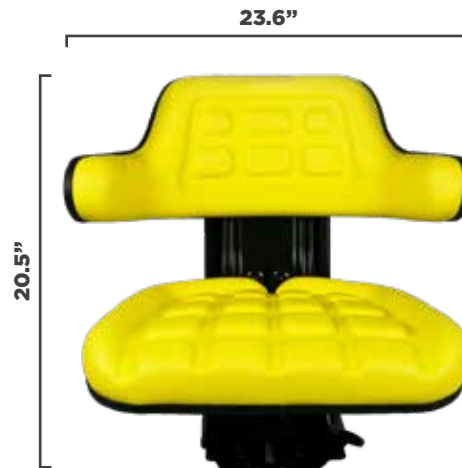

UNIVERSAL SUSPENSION SEAT

SEA-ECO2100BE

- Leatherette upholstery
- Steel frame
- Heavy duty vinyl cover
- Molded cushion
- Adjustable base with 5 mounting angles
- Fore/aft adjustable
- Weight adjustable suspension
- Includes mounting plate
- Includes slide track
- Black

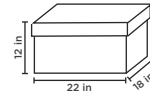
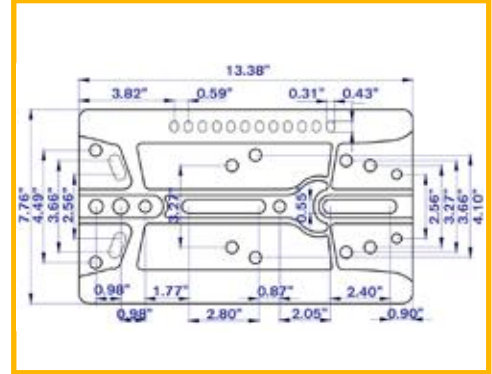

UNIVERSAL SUSPENSION SEAT

SEA-ECO2100BLUBE

- Leatherette upholstery
- Steel frame
- Heavy duty vinyl cover
- Molded cushion
- Adjustable base with 5 mounting angles
- Fore/aft adjustable
- Weight adjustable suspension
- Includes mounting plate
- Includes slide track
- Blue

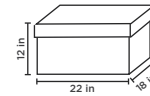
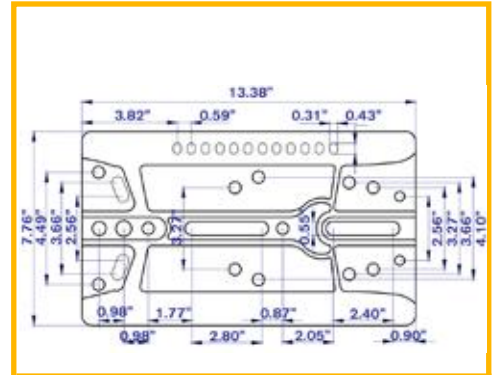

UNIVERSAL SEAT WITH SLIDE RAILS

SEA-50800BE

- Leatherette Upholstery
- Steel frame
- Heavy duty vinyl cover
- Molded cushion
- Adjustable slides
- Black

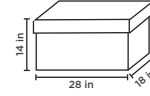
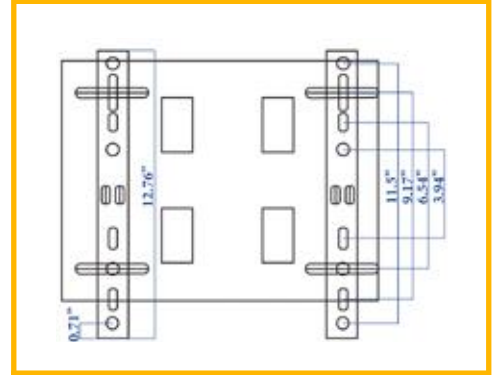

AGRICULTURAL SEATS

UNIVERSAL SUSPENSION SEAT

SEA-50800YBE

- Leatherette Upholstery
- Steel frame
- Heavy duty vinyl cover
- Molded cushion
- Adjustable slides
- Yellow

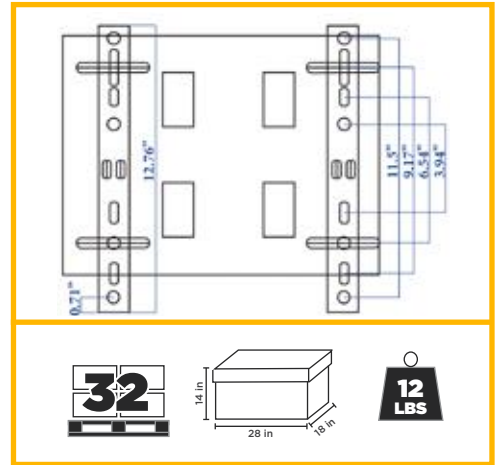
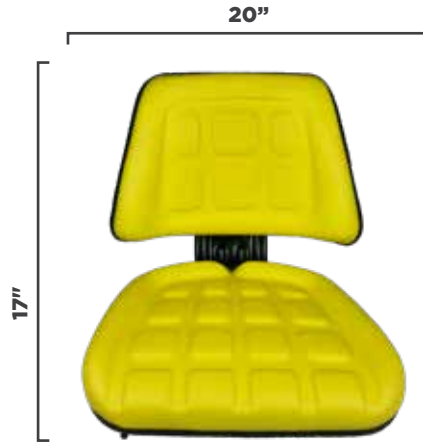

UNIVERSAL SUSPENSION SEAT

SEA-IH6012BE

- High density foam
- Heavy duty vinyl cover
- 3 piece molded cushion set
- Steel back
- Does not included mounting hardware
- Waterproof
- Includes drain holes
- See SEA-JZS561 for hardware
- Black & White

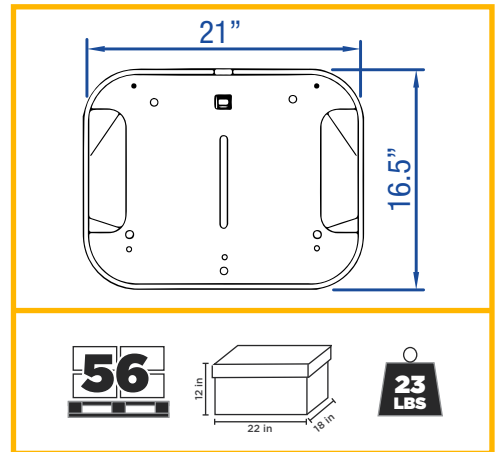

3 PIECE CUSHION SET

SEA-JD0550YE

- High density foam
- Heavy duty vinyl cover
- 3 piece molded cushion set
- Does not include mounting hardware
- Yellow

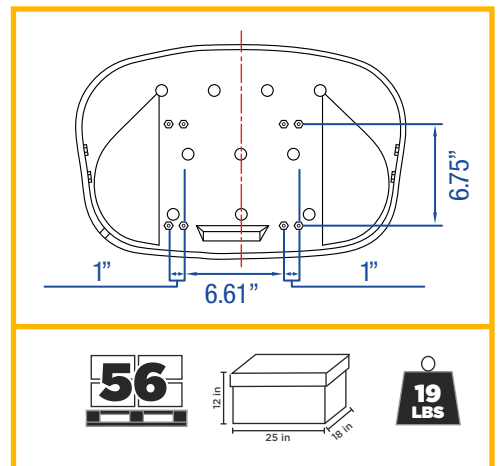

MOUNTING HARDWARE

SEA-JZS561

- Mounting Hardware
- For IH Black White Cushion Set
- See SEA-IH6012BE



2 PIECE CUSHION SET

SEA-JD5550YE

- High density foam
- Heavy duty vinyl cover
- 2 piece molded cushion set
- Steel back
- Waterproof
- Yellow

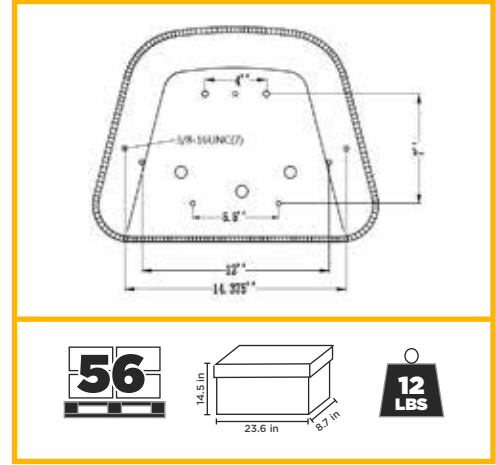
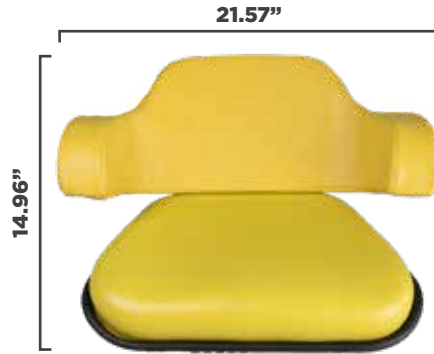

NARROW DELUXE SUSPENSION SEAT

SEA-COM2210

- Leatherette Upholstery
- Fore/aft Adjustment
- Weight Adjustable Suspension
- Narrow
- Black

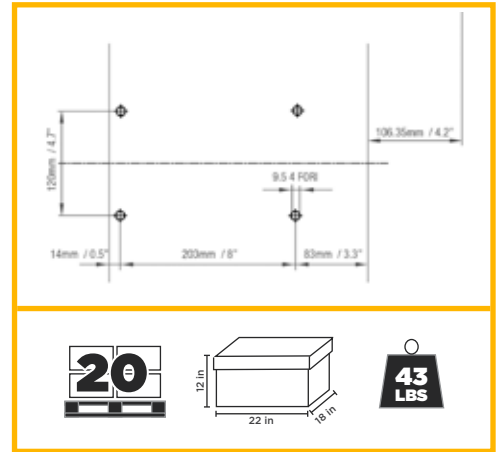

UNIVERSAL NARROW SEAT

SEA-11NBE

- Leatherette upholstery
- Vinyl covered molded cushion
- Fore/aft adjustable
- Non-suspension
- Waterproof
- Includes drain holes
- Black

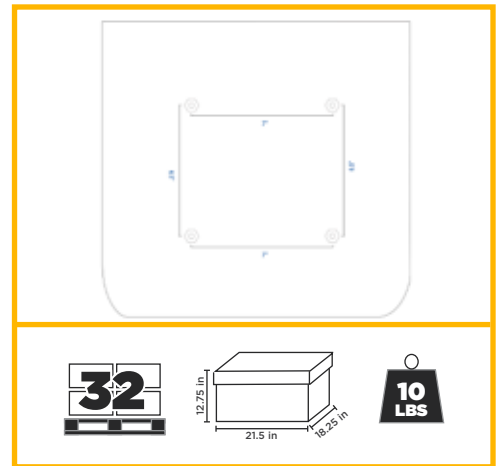

FLIP-UP BRACKETS

SEA-94000BE

- Mounting Hardware
- For 11NBEX Cushion Set See SEA-11NBE



ECONOMY CAB SUSPENSION SEAT

SEA-SC253000

- Premium black cloth
- Fore/aft adjustable
- Mechanical suspension
- Adjustable arm & head rests
- Includes seat belt
- Black

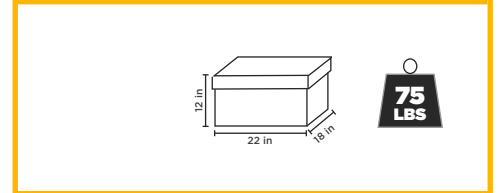
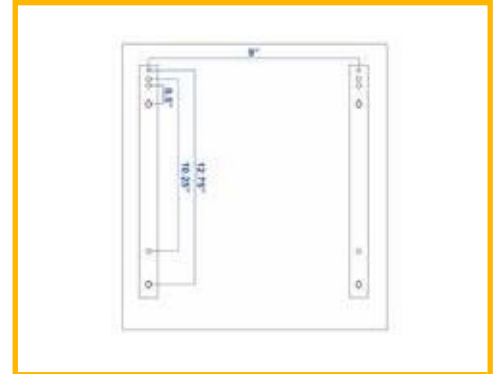

DELUXE CAB SUSPENSION SEAT

SEA-18DCSBE

- Premium cloth
- Fore/aft adjustment
- Air suspension
- Adjustable arm & head rests
- Includes seat belt
- Grey

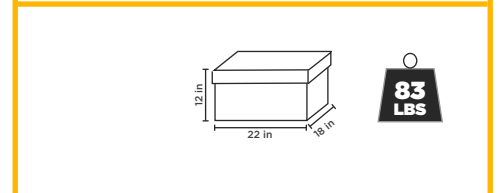
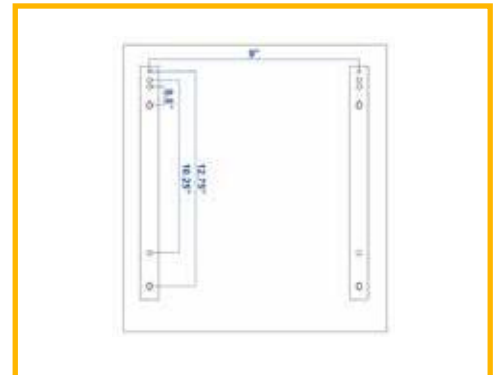

BLACK PAN SEAT

SEA-138BE

- Steel pan seat
- Includes hardware
- Black

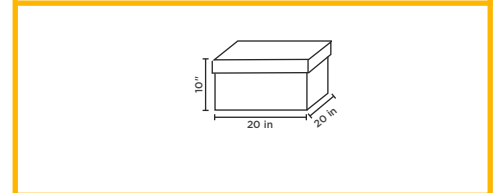
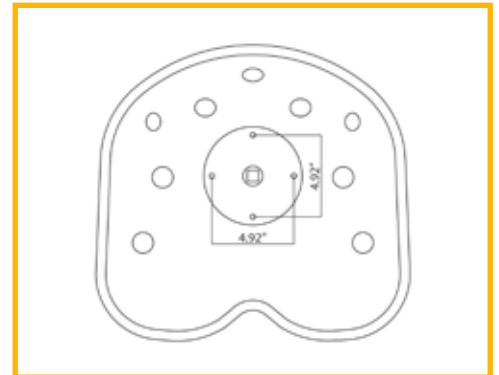

CONTOURED DELUXE SEAT

SEA-450BE

- Waterproof
- Includes drain holes
- Heavy duty slides
- Black

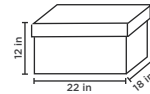
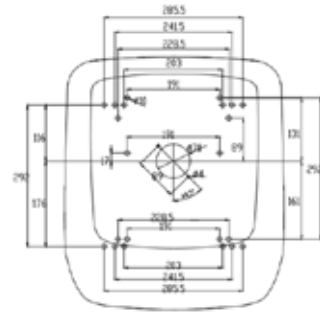

UNIVERSAL NARROW SEAT

CMP3100

- Steel back
- Narrow
- Black

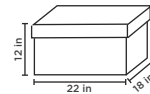
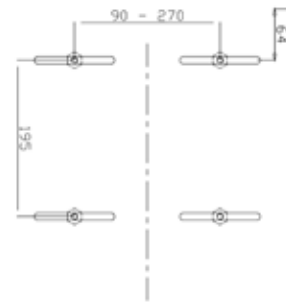

UNIVERSAL WIDE SEAT

CMP6100

- Steel back
- Non-adjustable
- Wide
- Black

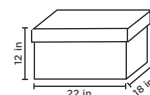
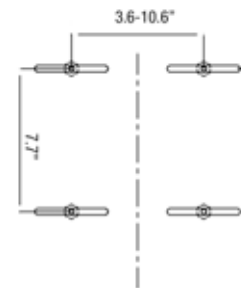

GREY SEAT COVER

SEA-50100BE

- 1 Piece Cushion
- Grey

**GREY SEAT COVER**

SEA-50200BE

- 1 Piece Cushion
- Grey
- Heavy Duty

**RED & WHITE SEAT COVER**

SEA-50300BE

- 1 Piece cushion
- Red & White

**BLACK SEAT COVER**

SEA-50500BE

- 1 Piece Cushion
- Black



BLACK UNIVERSAL WIDE SEAT SEA-LG6LBE

- Heavy duty vinyl
- Steel pan frame
- Waterproof
- Black



BLACK UNIVERSAL WIDE SEAT BOXED EDITION - 8 PACK SEA-LG6LBE-8



*MUST BE PURCHASED IN MULTIPLES OF 8

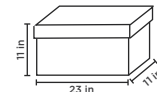
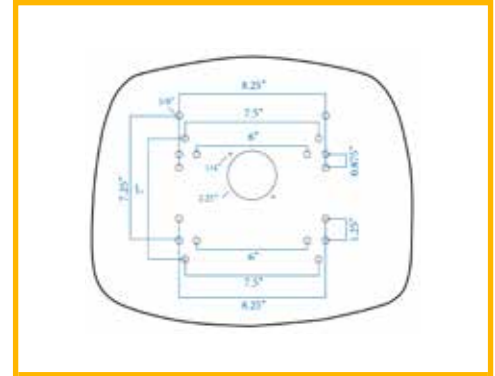

BLACK UNIVERSAL SEAT SEA-LG6BE

- Heavy duty vinyl
- Steel pan frame
- Waterproof
- Black

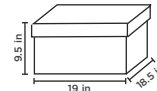
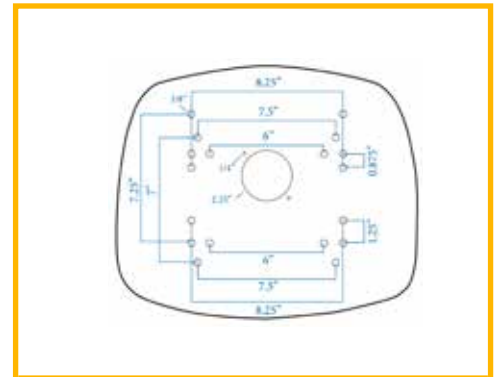

YELLOW UNIVERSAL SEAT SEA-LG6YBE

- Heavy duty vinyl
- Steel pan frame
- Waterproof
- Yellow

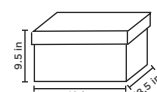
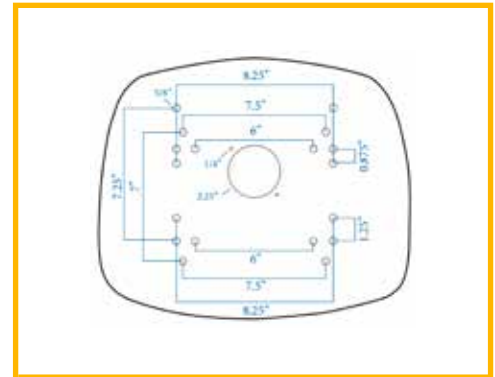

DELUXE HIGH STEEL BACK SEAT

SEA-135BE

- High density foam
- High steel back
- Universal mount
- Waterproof
- Extended back rest
- Black



DELUXE HIGH STEEL BACK SEAT

SEA-135YBE

- High density foam
- High steel back
- Universal mount
- Waterproof
- Extended back rest
- Yellow

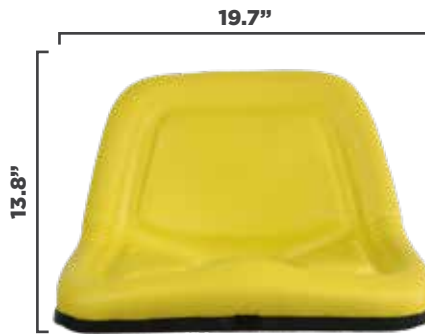

HIGH BACK COMPACT SEAT

SEA-800007

- Heavy duty vinyl
- Molded frame
- Universal mount
- Waterproof
- Black



LOW BACK SEAT

SEA-INI054

- Heavy duty vinyl
- Steel frame
- Deluxe cushion
- Low back
- Universal mount
- Waterproof
- Includes drain holes
- Black

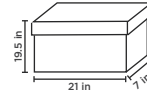
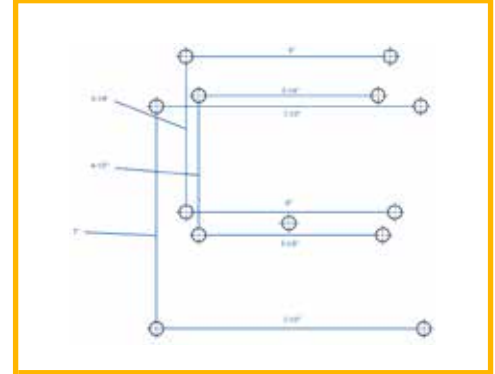

DELUXE ULTRA HIGH BACK SEAT

SEA-14010BE

- Integral polyurethane
- Heavy duty cover
- Includes flip brackets
- Waterproof
- Includes drain holes
- Includes slide track
- Accepts operator presence switch
- Black

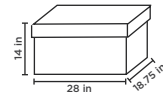
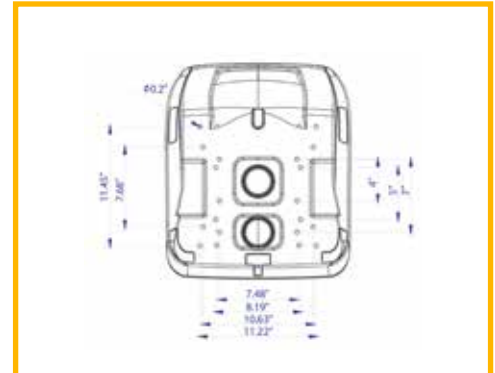
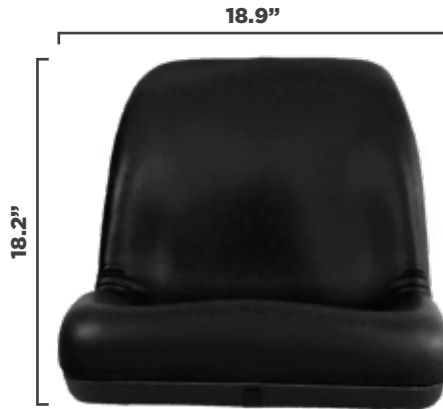

DELUXE ULTRA HIGH BACK SEAT

SEA-14010YBE

- Integral polyurethane
- Heavy duty cover
- Includes flip brackets
- Waterproof
- Includes drain holes
- Includes slide track
- Accepts operator presence switch
- Yellow

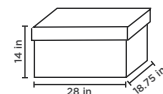
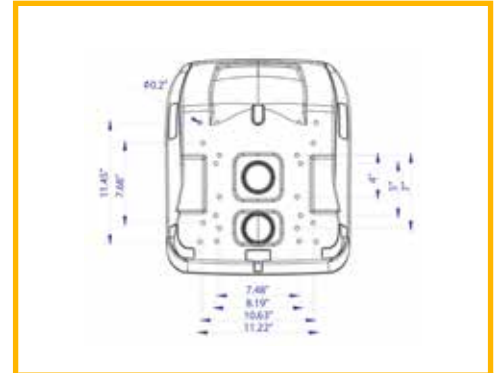
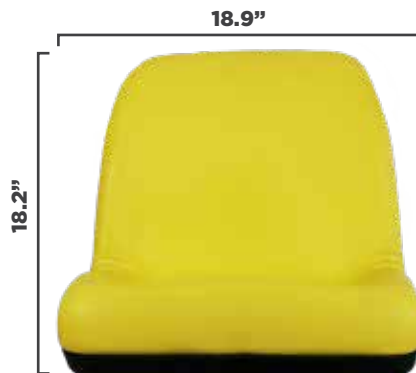

PADED PAN SEAT

SEA-100BE

- Heavy duty vinyl
- Steel pan frame
- Universal mount
- Waterproof
- Includes drain holes
- Black

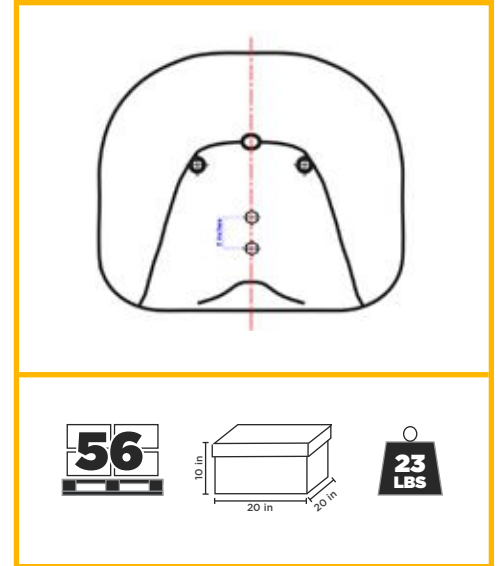

CONTOURED HIGH BACK SEAT

SEA-450SBE

- Waterproof
- Includes drain holes
- Heavy duty slides
- Black

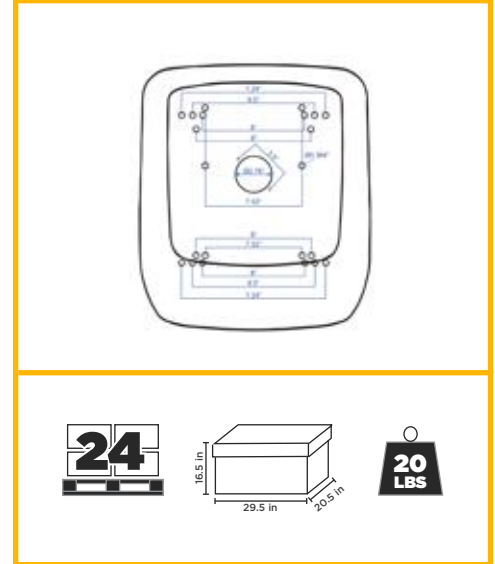

HIGH BACK COMPACT SEAT

SEA-53000BE

- Steel pan frame
- Heavy duty vinyl cover
- Includes drain holes
- Includes slide track
- Accepts operator presence switch

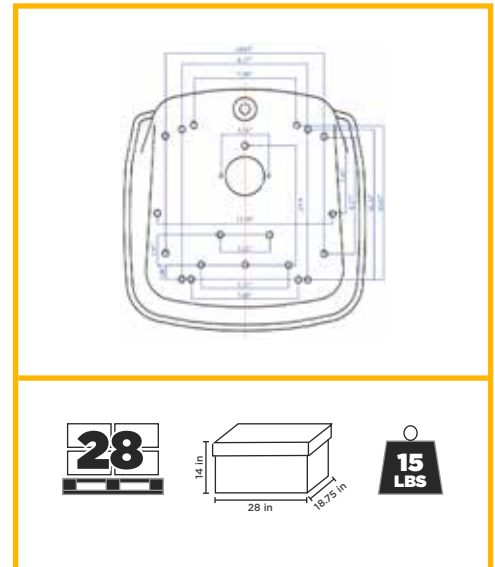

UNIVERSAL SKID STEER SEAT

SEA-46000BE

- Heavy duty vinyl
- Steel pan frame
- Waterproof
- Includes drain holes
- Heavy duty slides with studs
- Accepts operator presence switch

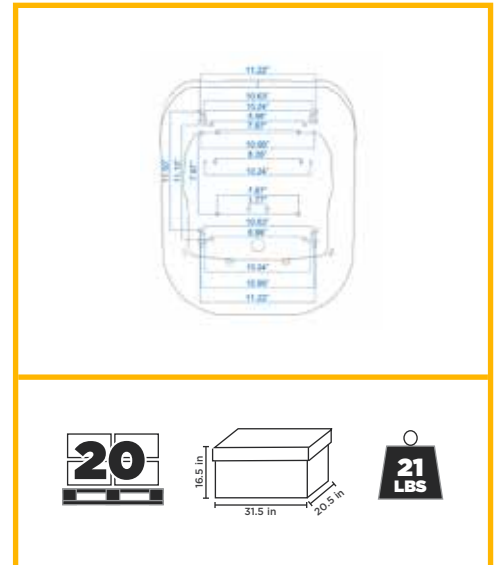

PREMIUM HIGH BACK SEAT

SEA-44002BE

- Heavy duty vinyl
- 3 Position lumbar support
- Adjustable arm rests
- Folding seat back
- Adjustable slides
- Document pocket in seat back

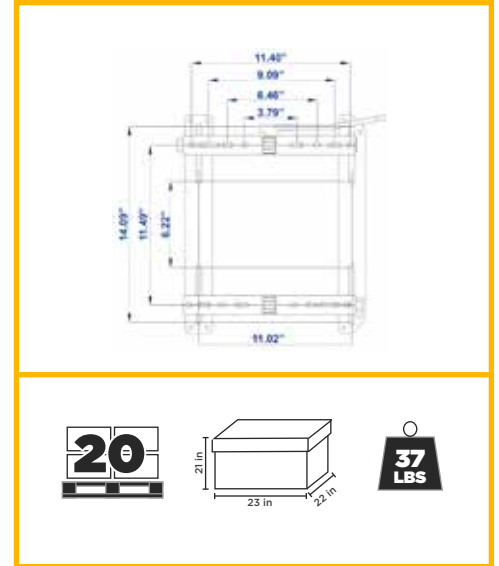

PREMIUM HIGH BACK SEAT

SEA-44000BE

- 2 piece cushion set
- Folding seat back
- 3 Position lumbar support
- Adjustable arm and back rests
- Water resistant
- Adjustable slides
- Document pocket in seat back
- Black

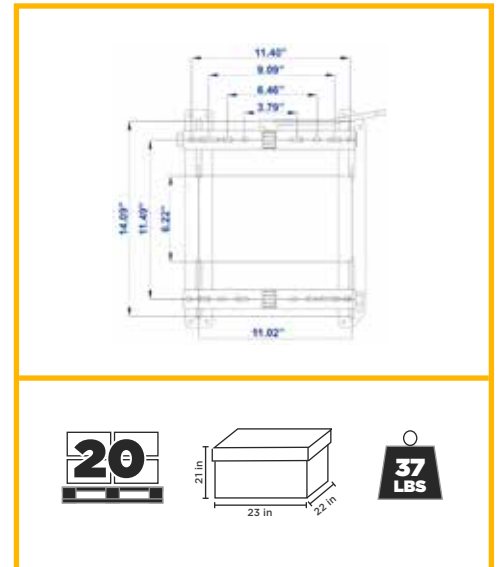

CONTOURED HIGH BACK SEAT

SEA-300INDBE

- Leatherette upholstery
- High density foam cushion
- Non-folding seat back
- Fore/aft adjustable
- Operator presence switch
- Black

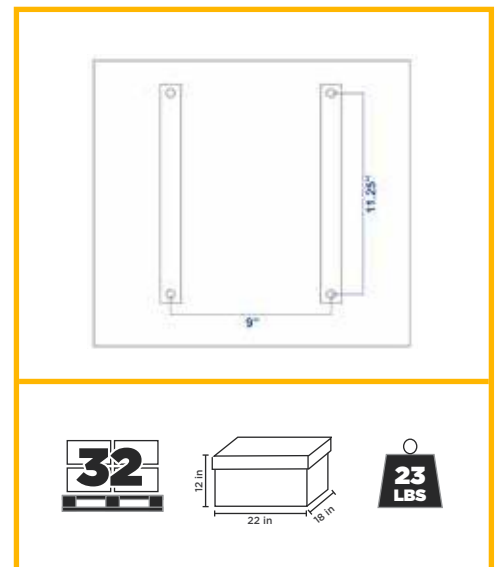

DELUXE FOLD DOWN BACK SEAT

SEA-35500BE

- Leatherette upholstery
- Steel frame with trimmed edges
- Heavy duty vinyl cover
- Molded cushion
- Folding seat back
- Fore/aft adjustable
- Adjustable arm rests
- Includes slide track
- Black

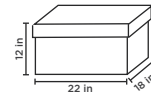
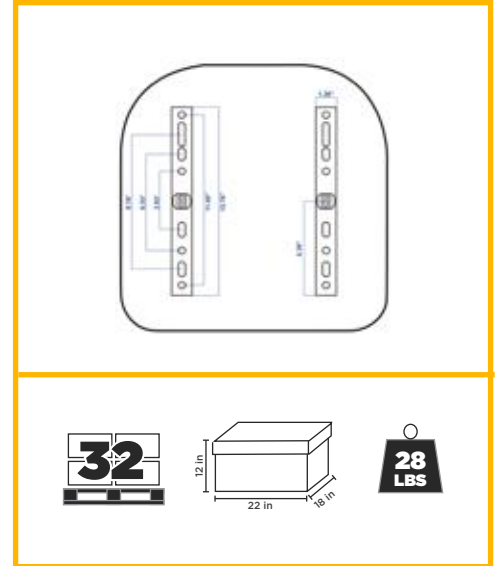

DANISH CULTIVATOR & PLOW PARTS

7" SWEEP
2 HOLE,
OEM 372560A1
 56.372.560



7" SWEEP
2 HOLE,
OEM 1547097C2
 56.547.097



2-3/4" SWEEP
2 HOLE, 2-3/4" X 6 MM
 56.000.019



10" SWEEP
10" X 1/4", 3/8" HOLE
 56.000.014



7" SWEEP
7" X 6 MM, 3/8" HOLE
 56.000.008



4" SWEEP
4" X 6 MM, 3/8" HOLE
 56.000.007



4", 5 SIDED SWEEP
4" X 5 SIDED, 3/8" HOLE
 56.000.025



2-3/4" SWEEP
2-3/4" X 6 MM, 3/8" HOLE
 56.000.006



2-3/4" SWEEP
2 3/4" X 6 MM, 7/16" HOLE
 56.444.006



C-SHANK SWEEP
4", 2 HOLE
 56.104.247



BOLT ASSEMBLIES

3/8" X 1-1/2"
 56.000.004

3/8" X 1-3/4"
 56.000.016

7/16 X 1-3/4"
 56.000.034



BOX QTYS
100/BOX

C-SHANK CULTIVATOR & PLOW PARTS

CLAMP
S-TINE 560/61
12 X 50 BAR F/32 X 10
56.000.002



CLAMP
2" TUBE 50 X 50 BAR F/32
56.000.005



HEAVY DUTY CLAMP
50 X 50 BAR F/45 X 12
56.000.021



HEAVY DUTY CLAMP
2-1/2" X 2-1/2" BAR F/45 X 12
56.000.022



REVERSIBLE POINT
40 X 60 X 200 REVERSIBLE
3/8" HOLE
56.000.003



REVERSIBLE POINT
40 X 6 X 215 REVERSIBLE
3/8" HOLE
56.000.017

7/16 HOLE VERSION
PART# 56.444.017



2 HOLE POINT
CULT REV 2 X 10, 1-3/4"
CENTERS 2 HOLE BE FIELD
CULTIVATORS
ART-460



REVERSIBLE POINT
60 X 6 X 260 REVERSIBLE
3/8" HOLE
56.000.020



STANDARD 10 MM S-TINE
32 X 10 X 550 / 1-1/4" X 3/8" X 22"
56.000.001



HEAVY DUTY 12 MM S-TINE
32 X 12 X 550 / 1-1/4" X 1/2" X 22"
56.000.010

45 X 12 X 660 HIGH CLEARANCE
56.000.018



NEW SERIES DIAMOND CULTIVATOR SWEEPS GUARANTEED FIT & QUALITY!

HARDNESS TESTED AT HRC 46-50 BRINELL HB 434-500

2-1/2" FORGED CULTIVATOR POINT
56.000.012



**4" FORGED CULTIVATOR POINT
SHORTNECK**
56.000.028



**2-1/2" FORGED CULTIVATOR POINT
WITH NUB**
56.000.013



**4" FORGED CULTIVATOR POINT
LONGNECK**
56.000.029



3" FORGED CULTIVATOR POINT
56.000.011



DIAMOND TINE

PART#	DESCRIPTION	A	B	C	D	E
61.200.002	HARROW 7"	9/16"	1-7/8"	7"	5/8"	5/8"

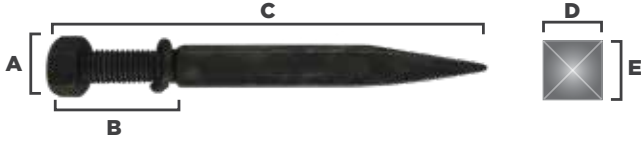

DIAMOND TINE

PART#	DESCRIPTION	A	B	C	D	E
61.200.004	HARROW 8"	9/16"	2"	8"	5/8"	5/8"



DIAMOND TINE

PART#	DESCRIPTION	A	B	C	D	E
61.200.016	7/16" THREAD	5/8"	7/8"	8"	7/8"	5/8"
61.200.017	1/2" THREAD	5/8"	7/8"	8"	7/8"	5/8"
61.200.018	7/16" THREAD	5/8"	7/8"	8"	7/8"	5/8"
61.200.019	1/2" THREAD	5/8"	7/8"	8 1/2"	7/8"	5/8"

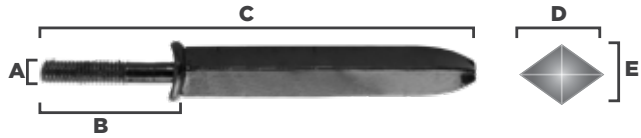

DIAMOND TINE

PART#	DESCRIPTION	A	B	C	D	E
61.200.020	W/HEAD	5/8"	-	8"	7/8"	5/8"



DIAMOND TINE

PART#	DESCRIPTION	A	B	C	D	E
61.200.021	NO HEAD	5/8"	-	8"	7/8"	5/8"



SQUARE TINE

PART#	DESCRIPTION	A	B	C	D	E
61.200.031	NO HEAD	5/8"	-	8"	5/8"	5/8"



SQUARE TINE

PART#	DESCRIPTION	A	B	C	D	E
61.200.032	NO HEAD	5/8"	-	10"	5/8"	5/8"



SQUARE TINE

PART#	DESCRIPTION	A	B	C	D	E
61.200.040	3/4" X 8" NO HEAD	3/4"	-	8"	3/4"	3/4"



DIAMOND/SQUARE TINE

PART#	DESCRIPTION	A	B	C	D	E
61.200.045	3/4" X 10" TINE, SQUARE NO HEAD	3/4"	-	10"	3/4"	3/4"
61.200.047	3/4" X 11" TINE, DIAMOND W/HEAD	3/4"	-	11"	3/4"	3/4"
61.200.049	3/4" X 12" TINE, DIAMOND W/HEAD	3/4"	-	12"	3/4"	3/4"
61.200.051	3/4" X 14" TINE, DIAMOND W/HEAD	3/4"	-	14"	3/4"	3/4"



RUBBER RAKE TINES

UNIVERSAL RUBBER RAKE TINE

45.300.916



YOKE HEIGHT	1-3/8"
BOLT HOLE DIAMETER	5/16"
TINE LENGTH FROM BOTTOM OF YOKE	7-1/4"
TINE DIAMETER	1/4"

REPLACES OEM	65609, 850612, AE24953, RMT-
INTERCHANGES WITH	300916, T16-0182

NH RUBBER RAKE TINE

45.300.114



YOKE HEIGHT	1-3/8"
BOLT HOLE DIAMETER	5/16"
TINE LENGTH FROM BOTTOM OF YOKE	7-1/4"
TINE DIAMETER	1/4"

REPLACES OEM	65668, 850613
INTERCHANGES WITH	300114, T16-0154

RUBBER RAKE TOOTH

45.300.213



YOKE HEIGHT	1-3/8"
BOLT HOLE DIAMETER	5/16"
TINE LENGTH FROM BOTTOM OF YOKE	7-1/4"
TINE DIAMETER	1/4"

REPLACES OEM	139041, 850614
INTERCHANGES WITH	300213, T16-0166

RUBBER RAKE TOOTH

45.300.718



YOKE HEIGHT	1-5/8"
BOLT HOLE DIAMETER	3/8"
TINE LENGTH FROM BOTTOM OF YOKE	10"
TINE DIAMETER	9/32"

REPLACES OEM	AE56204, EF288801, 2888-001
INTERCHANGES WITH	300718, T16-0185

DOUBLE RAKE TINE

45.300.510



YOKE HEIGHT	1-3/8"
BOLT HOLE DIAMETER	5/16"
TINE LENGTH FROM BOTTOM OF YOKE	7-1/4"
TINE DIAMETER	1/4"

REPLACES OEM	2117RH, 400341, 491478
INTERCHANGES WITH	352052, T16-0190

RUBBER RAKE TOOTH

45.300.411



YOKE HEIGHT	1-1/8"
BOLT HOLE DIAMETER	5/16"
TINE LENGTH FROM BOTTOM OF YOKE	7-1/2"
TINE DIAMETER	1/4"

REPLACES OEM	7500630, H60003, 504-055, 106000
INTERCHANGES WITH	300411

FINGER WHEEL TINE

45.092.611

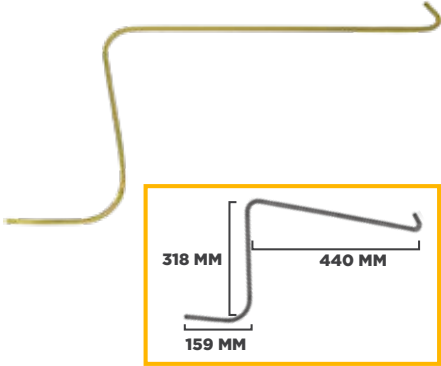

FINGER WHEEL TINE

45.036.133

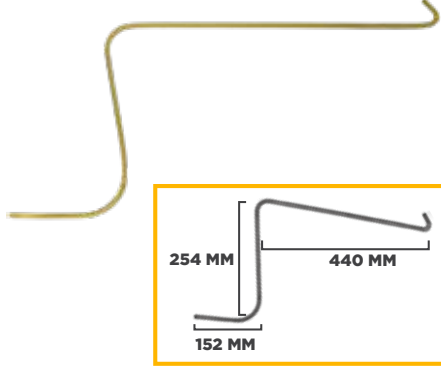

FINGER WHEEL TINE

45.000.176

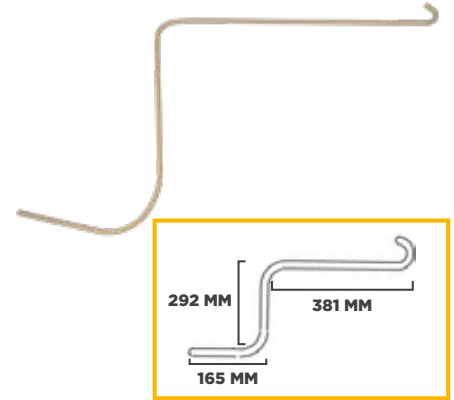

**NH RAKE TINE
TOP KUHN JUNIOR
OEM 64562**

45.064.562



**JD RAKE TINE
OEM TP257SE**

45.000.257



**JD RAKE TINE
OEM 186SE**

45.160.320



**IH RAKE TINE
OEM 457374R1/462978R**

45.160.126



**JD BALER TINE
OEM E61295**

45.061.295



**NH BALER TINE
OEM 131673**

45.131.673



BE-TR300 NARROW RAKE TINE
RH, HAYBOB
45.000.106

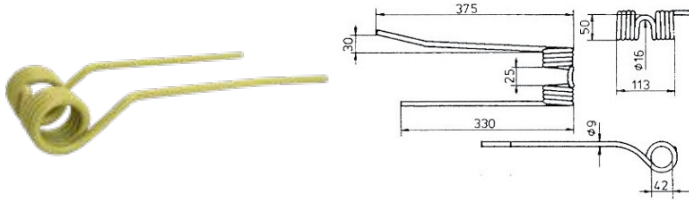

KUHN GRS RAKE TINE
KUHN # 57601100 FITS GRS 20, 21, 24
45.000.013

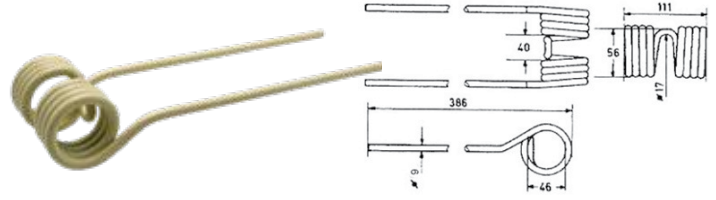

BE-TR300 NARROW RAKE TINE
LH, HAYBOB
45.000.107

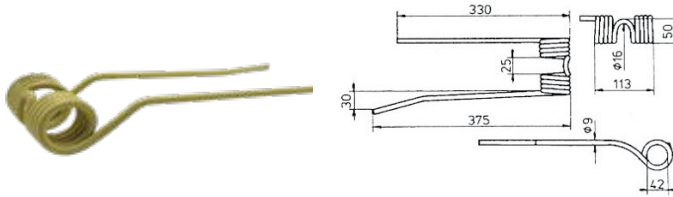

PZ-ZWEEGERS RAKE TINE
LH, FANEX # 339
45.000.025

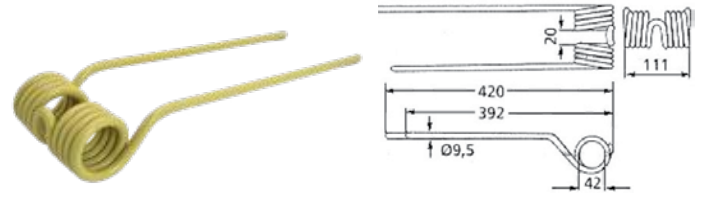

BE-TR300 WIDE RAKE TINE
LH, HAYBOB
45.000.110

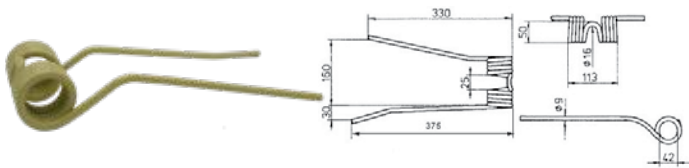

PZ-ZWEEGERS RAKE TINE
RH, FANEX # 340
45.000.026

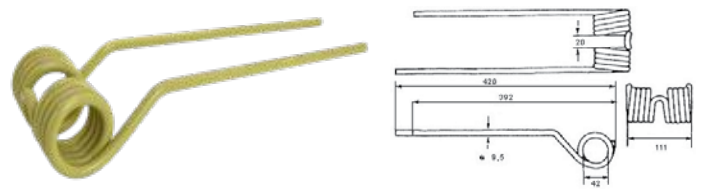

BE-TR300 WIDE RAKE TINE
RH, HAYBOB
45.000.111

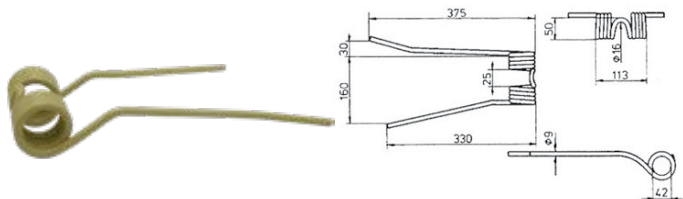

DA ROS GR TINE
DA ROS, MODELS GR300/330/380/410
OEM 6900220
45.000.220

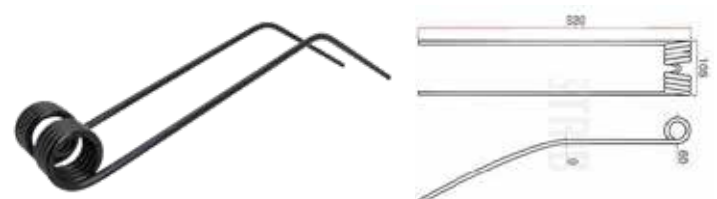

FELLA TEDDER TINE
FELLA TH SERIES
45.000.350

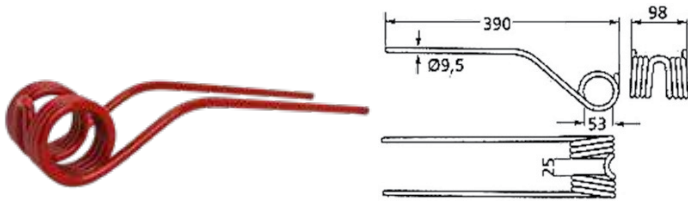

KUHN GS RAKE TINE
KUHN # 57701700 FITS: GA 230, 280, 300, 402
45.000.400

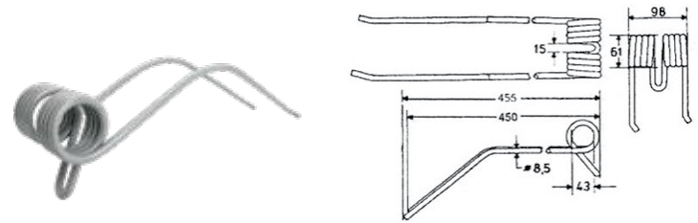

FELLA TS RAKE, OLD STYLE
TS 290, 320, 330, 335DN, 631
45.000.351

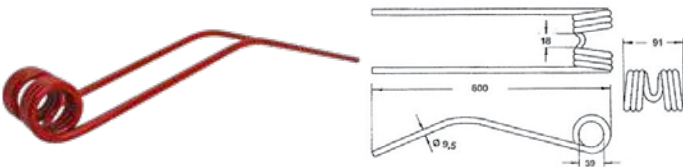

CLAAS LINER VOLTO RAKE TINE
CLAAS 9568151
45.000.700

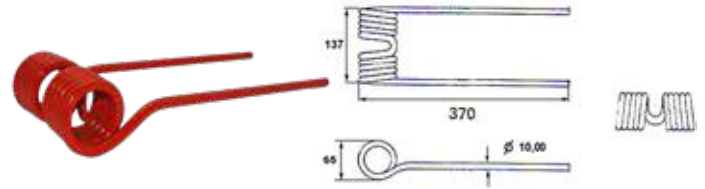

FELLA TS RAKE NEW STYLE
TS 340, 390, 425, 455, 670, 781
45.000.361

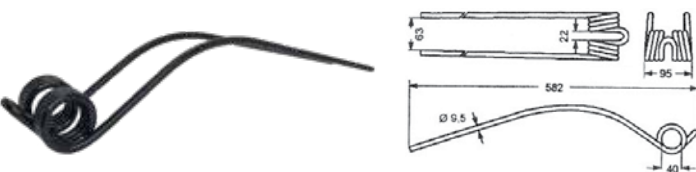

CLAAS LINER N/S RAKE TINE
CLAAS 9557100
45.000.710

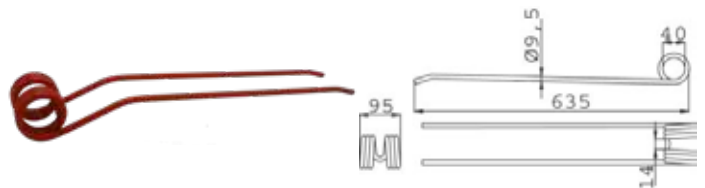

FELLA TS RAKE NEW STYLE NARROW
TS 1601, 1601
45.000.362



CLAAS LINER O/S RAKE TINE
CLAAS 9536290
45.000.750

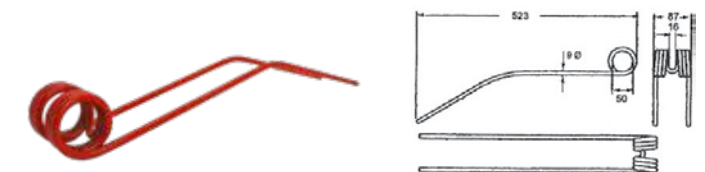

SICKLE GUARDS

DOUBLE FINGER GUARD

PART#	55.030.014
FITS MACHINE	CASE IH, CATERPILLAR, CHALLENGER, CLAAS
REPLACES OEM	676235N
INTERCHANGES	FQ207



DOUBLE FINGER GUARD

PART#	55.030.031
FITS MACHINE	CASE IH, NEW HOLLAND, NEW IDEA
REPLACES OEM	1326787C3, 483500R4, 187346A1
INTERCHANGES	BU210, FQ210



DOUBLE FINGER GUARD

PART#	55.030.001
FITS MACHINE	BADGER NORTHLAND, CASE IH, HESSTON, MACDON, MASSEY FERGUSON, NEW HOLLAND
REPLACES OEM	683994M1, 700707147, 88615982, 700716292, 23064, 28013, 683476M1, 683994M1, 219191, 858778, 86521587, 86553340, 86615982
INTERCHANGES	HA215M, BU215A, FQ215



DOUBLE FINGER GUARD

PART#	55.030.215
FITS MACHINE	BADGER NORTHLAND, CASE IH, HESSTON, MACDON, MASSEY FERGUSON, NEW HOLLAND
REPLACES OEM	683994M1, 700707147, 88615982, 700716292, 23064, 28013, 683476M1, 683994M1, 219191, 858778, 86521587, 86553340, 86615982
INTERCHANGES	BU215H, FQ215DH



DOUBLE FINGER GUARD

PART#	55.030.018
FITS MACHINE	CASE IH, MACDON
REPLACES OEM	87560324, 87421451, 47687886, 118344
INTERCHANGES	BU215H, FQ215H



DOUBLE FINGER GUARD

PART#	55.030.344
FITS MACHINE	CASE IH, MACDON
REPLACES OEM	87560324, 87421451, 47687886, 118344
INTERCHANGES	BU215H, FQ215H



DOUBLE FINGER GUARD

PART#	55.030.002
FITS MACHINE	MACDON, NEW HOLLAND
REPLACES OEM#	219190
INTERCHANGES	BU218, FQ218



DOUBLE FINGER GUARD

PART#	55.030.718
FITS MACHINE	MACDON, NEW HOLLAND
REPLACES OEM#	219190
INTERCHANGES	BU218H, FQ218



DOUBLE FINGER GUARD

PART#	55.030.104
FITS MACHINE	GEHL, JOHN DEERE
REPLACES OEM	E48093, E82559, 072057
INTERCHANGES	BU220, FQ220



DOUBLE FINGER GUARD

PART#	55.030.225
FITS MACHINE	AGCO, GLEANER, MASSEY FERGUSON
REPLACES OEM	71116504, 71341601, 71386962
INTERCHANGES	BU225, FQ225



DOUBLE FINGER GUARD

PART#	55.030.306
FITS MACHINE	AGCO, CCIL
REPLACES OEM	J-1306
INTERCHANGES	BU230



DOUBLE FINGER GUARD

PART#	55.030.070
FITS MACHINE	MACDON, MASSEY FERGUSON
REPLACES OEM	1041468M1GV, 798G235, BU235GV, G235, TP-W30341GV, TPW30341GV
INTERCHANGES	BU235, FQ235



DOUBLE FINGER GUARD

PART#	55.030.005
FITS MACHINE	JOHN DEERE, MASSEY FERGUSON, NEW HOLLAND, NEW IDEA, WHITE
REPLACES OEM	H113571, H145791, H153719, H171031, H61954, H75386, 228392M1, 228392M2, 134024, 714611, 9510220
INTERCHANGES	MCM240A, FQ240A, BU240



DOUBLE FINGER GUARD

PART#	55.030.017
FITS MACHINE	JOHN DEERE
REPLACES OEM	Z11228
INTERCHANGES	



DOUBLE FINGER GUARD

PART#	55.030.106
FITS MACHINE	CASE IH, FIELD QUEEN, GEHL, HESSTON, NEW HOLLAND, NEW IDEA, VERSATILE
REPLACES OEM	700700845, 611179, 611902, 49239, 748178, 65327, V94711
INTERCHANGES	HA66-2, HA245, BU245, FQ245



DOUBLE FINGER GUARD

PART#	55.030.250
FITS MACHINE	CASE IH, GEHL, HESSTON, JOHN DEERE, NEW HOLLAND
REPLACES OEM	049312, 060494, E71880, 257654
INTERCHANGES	BU250, FQ250



DOUBLE FINGER GUARD

PART#	55.030.007
FITS MACHINE	CASE IH, GEHL, NEW IDEA
REPLACES OEM	613838R2, 187350A1, 044779, 61383R2
INTERCHANGES	BU270, FQ270



DOUBLE FINGER GUARD

PART#	55.030.275
FITS MACHINE	LOVE, JOHN DEERE, MASSEY FERGUSON, NEW HOLLAND
REPLACES OEM	271971
INTERCHANGES	BU275, FQ275



DOUBLE FINGER GUARD

PART#	55.030.280
FITS MACHINE	NEW HOLLAND, NEW IDEA
REPLACES OEM#	290385
INTERCHANGES	BU280, FQ280



DOUBLE FINGER GUARD

PART#	55.030.290
FITS MACHINE	JOHN DEERE, VERSATILE
REPLACES OEM#	V1605, SW1605, 9705050
INTERCHANGES	BU290, FQ290



DOUBLE FINGER GUARD

PART#	55.030.299
FITS MACHINE	CASE IH
REPLACES OEM	1307299C1, 1307299C2, 87442324
INTERCHANGES	BU299, FQ299



DOUBLE FINGER GUARD

PART#	55.030.201
FITS MACHINE	AGCO, CHALLENGER, JOHN DEERE, HONEY BEE, NEW HOLLAND
REPLACES OEM	10616.10, 16500.10
INTERCHANGES	G81-0201



DOUBLE FINGER GUARD

PART#	55.030.015
FITS MACHINE	CASE IH, MASSEY FERGUSON
REPLACES OEM	44102900, 44104500
INTERCHANGES	



TRIPLE FINGER GUARD

PART#	55.030.006
FITS MACHINE	JOHN DEERE
REPLACES OEM	H229537, H213398, H205992, H205448
INTERCHANGES	



TRIPLE FINGER GUARD

PART#	55.030.043
FITS MACHINE	JOHN DEERE
REPLACES OEM	H213405, H229539
INTERCHANGES	FG5043



TRIPLE FINGER GUARD

PART#	55.030.543
FITS MACHINE	JOHN DEERE
REPLACES OEM	H229537, H213398, H205992, H205448
INTERCHANGES	



TRIPLE FINGER GUARD

PART#	55.030.004
FITS MACHINE	VINTAGE FORD, JOHN DEERE
REPLACES OEM	H229538, AH213055, H213507
INTERCHANGES	FG7053



TRIPLE FINGER GUARD

PART#	55.030.753
FITS MACHINE	VINTAGE FORD, JOHN DEERE
REPLACES OEM	H229538, AH213055, H213507
INTERCHANGES	FG7053H



TRIPLE FINGER GUARD

PART#	55.030.053
FITS MACHINE	JOHN DEERE
REPLACES OEM#	H213508, H229540
INTERCHANGES	FG8053



TRIPLE FINGER GUARD

PART#	55.030.853
FITS MACHINE	JOHN DEERE
REPLACES OEM	H213508, H229540
INTERCHANGES	FG8053H



EXTRA HEAVY, UNDER SERRATED, CHROME

PART#	55.211.001
SIZE	3-1/4" X 2-1/16"
FITS MACHINE	CASE-IH, KOSCH, MASSEY NEW HOLLAND, NEW IDEA, OWATONNA, ROWSE
REPLACES OEM	826722C1, 826722C2, K165, 1036362M1, 29875, OU577HS, 340-32049, M22831

10 PACK



HEAVY, UNDER SERRATED, CHROME

PART#	55.211.022
SIZE	3-1/4" X 2"
FITS MACHINE	JE LOVE, JOHN DEERE, FORD, TRIUMPH AGCO-ALLIS
REPLACES OEM	L191, E76373, Z7030H, 141198, 646, 70802541

10 PACK



HEAVY, TOP SERRATED, CHROME

PART#	55.212.012
SIZE	3-1/4" X 2-1/16"
FITS MACHINE	FORD, NEW HOLLAND, HESSTON, VERSATILE
REPLACES OEM	94579, 049254, 596321R1, 604921H

10 PACK



EXTRA HEAVY, TOP SERRATED, CHROME

PART#	55.212.001
SIZE	3-1/4" X 2-1/16"
FITS MACHINE	CASE-IH NEW HOLLAND, HESSTON, MASSEY, OWATONNA
REPLACES OEM	049213, 596321R3, 700705300, 86616527, 6839366M1, 340-16457

10 PACK



EXTRA HEAVY, TOP SERRATED, CHROME

PART#	55.204.170
SIZE	3-1/4" X 2-1/8"
FITS MACHINE	JOHN DEERE, MACDON, NEW HOLLAND, CASE-IH
REPLACES OEM	W34602CR, W35888CR, 34390, 107170M1, 137448C1CR, 84342590

10 PACK



EXTRA HEAVY, TOP SERRATED, LARGE TOOTH, CHROME

PART#	55.203.325
SIZE	3-1/4" X 2-1/16"
FITS MACHINE	CASE-IH, NEW HOLLAND, OWATONNA, HESSTON
REPLACES OEM	112074A1, 86616588, 86615988, 9622744, 86616691, SS340-32015, 70075299

10 PACK



EXTRA HEAVY, TOP SERRATED, LARGE TOOTH, CHROME

PART#	55.204.268
SIZE	3-1/4" X 2-1/16"
FITS MACHINE	CASE-IH, NEW HOLLAND, OWATONNA, HESSTON
REPLACES OEM	191256A1, SS596321R3, 596321R4, 86616689, 700705300, SS700705300, SS340-32015CR

10 PACK



EXTRA HEAVY, TOP SERRATED, CHROME

PART#	55.211.211
SIZE	3-1/4" X 2-1/16"
FITS MACHINE	CASE-IH, NEW HOLLAND, KOSCH
REPLACES OEM	9622744, 826720C2, 826720C3, 86615988, K164CR

10 PACK



EXTRA HEAVY, UNDER SERRATED, CHROME

PART#	55.212.061
SIZE	3-1/4" X 2-1/16"
FITS MACHINE	FIELD QUEEN, GEHL, KOSCH, MASSEY, CASE-IH, NEW HOLLAND, OWATONNA, NEW IDEA
REPLACES OEM	457607R2, 060635, K165CR, 683937M1, 457607R3, 706226, 0188HS, 340-32049CR

10 PACK



REGULAR, UNDER SERRATED, CHROME

PART#	55.212.063
SIZE	3-1/4" X 2-1/16"
FITS MACHINE	CASE-IH, NEW HOLLAND, HESSTON
REPLACES OEM	457606R2, 048009, 604800

10 PACK



REGULAR, TOP SERRATED, CHROME

PART#	55.212.213
SIZE	3" X 2-1/16"
FITS MACHINE	VERSATILE
REPLACES OEM	SW1616CR

10 PACK



EXTRA HEAVY, TOP SERRATED, CHROME

PART#	55.232.882
SIZE	3-1/4" X 2"
FITS MACHINE	SCHUMACHER, JOHN DEERE
REPLACES OEM	26208CR, 420-100-058, AZ41727

10 PACK



SICKLE SECTION KNIFE KITS & WEAR PLATES

RIGHT HAND, EXTRA HEAVY, TOP SERRATED, CHROME 2 PACK

PART#	55.204.210
SIZE	3-3/4" X 3-1/4"
FITS MACHINE	UNIVERSAL, CASE-IH, FORD / NEW HOLLAND, GLEANER, JOHN DEERE
REPLACES OEM	148200C1, E63245

2 PACK



WEAR PLATES 5-7/8" LONG SLOTTED WITH 3" SPACING 2 PACK

PART#	55.440.591
SIZE	5-7/8"
FITS MACHINE	UNIVERSAL, NEW HOLLAND, AGCO-ALLIS, CASE-IH
REPLACES OEM	W50, 141021



STEEL LOW ARCH HOLD DOWN CLIPS 2 PACK

PART#	55.450.692
FITS MACHINE	CASE-IH, GEHL, HESSTON, JOHN DEERE, MASSEY FERGUSON, FORD/NEW HOLLAND, NEW IDEA
REPLACES OEM	613842R2, H7542, 241216, E47955, 1041469M1, 130431M1, 1055108M1, 67357, 137651, 290816



STEEL HIGH ARCH HOLD DOWN CLIPS 2 PACK

PART#	55.450.693
FITS MACHINE	CASE-IH, HESSTON
REPLACES OEM	611759R1, 595648R1, 142984



STEEL LOW ARCH HOLD DOWN CLIPS 2 PACK

PART#	55.450.419
FITS MACHINE	VERSATILE
REPLACES OEM	SW202





55.904.500

SICKLE SECTION BOLT-ON FASTENERS

PART#	DESCRIPTION	LENGTH	NO/PCS
55.904.500	BOLT W/ LOCKNUT	5/8"	50
55.550.058	COUNTERSUNK	1"	20
55.550.085	HEAD BOLTS	1"	15
55.550.095	HEAD BOLTS	1-5/16"	12



55.360.462

SICKLE SECTION RIVETS

PART#	DESCRIPTION
55.360.462	SICKLE SECTION RIVETS, 1 LB, 5/8" LENGTH X #5, 1/2" OVAL HEAD, ZINC PLATED



55.360.524

SICKLE SECTION RIVET ASSORTMENT

PART#	DESCRIPTION
55.360.524	SICKLE SECTION RIVET ASSORTMENT, 82 PIECES, 3 SIZES

ASSORTMENT CONTENTS

RIVET SIZE	PIECES
5/8" X #5, 1/2" OVAL HEAD	72
1" X #5, 1/2" OVAL HEAD	5
1-1/4" X #5, 1/2" OVAL HEAD	5



55.380.560

PITMAN ARM

PART#	DESCRIPTION
55.380.560	PITMAN ARM, UNIVERSAL WOOD

HAY MOWER BLADES CW & CCW

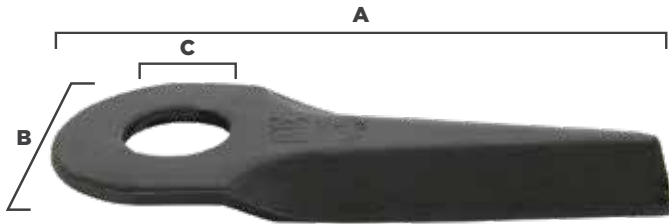

JOHN DEERE

BRABER#	JOHN DEERE#	DESCRIPTION	A	B	C
55.000.007	CC19993	SHORT SPOON	130	49	20.5 X 22.8 OVAL

NEW HOLLAND

BRABER#	NEW HOLLAND#	DESCRIPTION	FITS MODELS	A	B	C
55.000.007	697551	SHORT SPOON	442, 462	130	49	20.5 X 22.8 OVAL

TAARUP

BRABER#	TAARUP#	DESCRIPTION	FITS MODELS	A	B	C
55.000.007	56-110-300	SHORT SPOON	204, 205, 206	130	49	20.5 X 22.8 OVAL

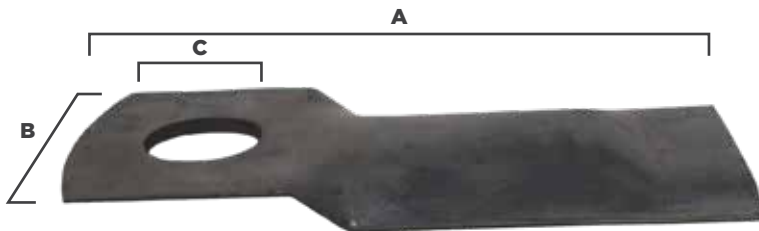

TAARUP

BRABER#	TAARUP#	DESCRIPTION	A	B	C
55.293.100	56-293-100	SHORT SPOON	131	50	20.5 X 22.8 OVAL

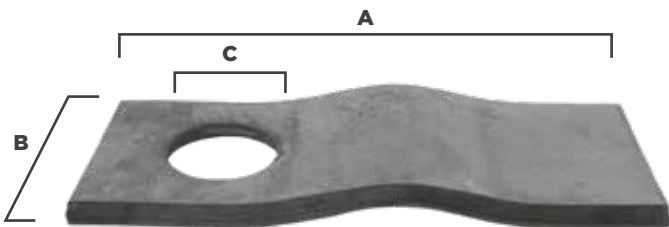

PZ-ZWEEGERS

BRABER#	PZ-ZWEEGERS#	FOR MODELS	A	B	C
55.000.010	CM120	CM 135, CM 165	105	47	21

SIP

BRABER#	SIP#	FOR MODELS	A	B	C
55.000.010	151019702	ROTO 135, 165, 185, RK1650	105	47	21

ALL MEASUREMENTS ARE IN MILLIMETERS UNLESS OTHERWISE STATED (1" = 25.4 MM)

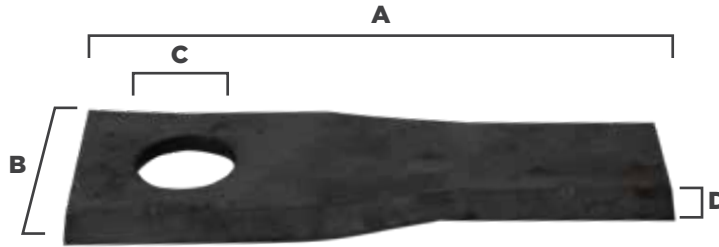

BUSH HOG

BRABER#	ROTATION	HANDLE	BUSH HOG#	FITS MODELS	A	B	C	D
55.000.011	CCW	LH	526215	DM18, DM19, DM7, DM8 DM9, HM5, HM7, HM8	120	48	18.5	4
55.000.012	CW	RH	526216		120	48	18.5	4

CASE IH

BRABER#	ROTATION	HANDLE	CASE IH#	FITS MODELS	A	B	C	D
55.000.012	CW	RH	ZA526215	3204, 3205, 3206, 3209, ALL WITH STANDARD DISK	120	48	18.5	4
55.000.011	CCW	LH	ZA526215		120	48	18.5	4
55.000.857	CW	RH	700711857	8309, 8312, 8315, 8850	108	48	18.5	4
55.000.858	CCW	LH	700711858		108	48	18.5	4
55.952.420	CW	RH	952042	DISCO 2650, 3050, 3450	115	47.75	19	4
55.952.430	CCW	LH	952043		115	47.75	19	4

CLAAS

BRABER#	ROTATION	HANDLE	CLAAS#	FITS MODELS	A	B	C	D
55.952.420	CW	RH	952.042	DISCO 2650, 3050, 3450	115	47.75	19	4
55.952.430	CCW	LH	952.043		115	47.75	19	4

FELLA

BRABER#	ROTATION	HANDLE	FELLA#	FITS MODELS	A	B	C	D
55.000.104	CW	RH	122.330	SM 165, SM 206, SM 216, SM 240, SH 167, SH 207, SH 247, SM168, SM208	106	48	19	4
55.000.103	CCW	LH	122.329		106	48	19	4
55.000.117	CCW	LH	131.117	SM 270, SM 210, SM 320, SM 350, SM310	111	48.75	19	4
55.000.118	CW	RH	131.118		111	48.75	19	4
55.000.174	CW	RH	N/A	SM 900	118	48.75	19	4
55.000.175	CCW	LH	N/A		118	48.75	19	4

GEHL

BRABER#	ROTATION	HANDLE	GEHL#	FITS MODELS	A	B	C	D
55.000.011	CCW	LH	604658	2310, 2330, DC1080, DC2350, DH140, DH160	120	48	18.5	4
55.000.012	CW	RH	604659		120	48	18.5	4

HESSTON

BRABER#	ROTATION	HANDLE	HESSTON#	FITS MODELS	A	B	C	D
55.000.015	CW	RH	700712888	10° LIFT, 1320, 1340, 1360, 1365	107	45	18	4
55.000.016	CCW	LH	700712889		107	45	18	4
55.000.857	CW	RH	700711857	11° LIFT, 1320, 1340, 1360, 1365	108	48	18.5	4
55.000.858	CCW	LH	700711858		108	48	18.5	4
55.000.575	CW	RH	700715575	18° LIFT, 1320, 1340, 1360, 1365	107	45	18	4
55.000.576	CCW	LH	700715576		107	45	18	4

INTERNATIONAL

BRABER#	ROTATION	HANDLE	INTERNATIONAL#	FITS MODELS	A	B	C	D
55.000.011	CCW	LH	56890	3204, 3205, 3206	120	48	18.5	4
55.000.012	CW	RH	58700		120	48	18.5	4

ALL MEASUREMENTS ARE IN MILLIMETERS UNLESS OTHERWISE STATED (1" = 25.4 MM)

HAY MOWER BLADES CW & CCW

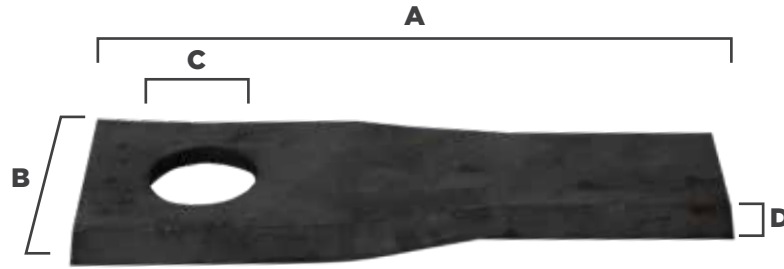

JOHN DEERE

BRABER#	ROTATION	HANDLE	JOHN DEERE#	FITS MODELS	A	B	C	D
55.000.015	CW	RH	E80208	920, 930, 1350, 1360, 1460, 1470	107	45	18	4
55.000.016	CCW	LH	E80206		107	45	18	4

KUHN

BRABER#	ROTATION	HANDLE	KUHN#	FITS MODELS	A	B	C	D
55.000.780	CW	RH	564.512.00	GHD44, 44HD, 55, 55HD, 66, 66HD, 77, GMD SELECT	122	48	18.5	4
55.000.781	CCW	LH	564.513.00		122	48	18.5	4
55.000.015	CW	RH	559.033.10	FC252G, 353GC, 350G, 300 GMD500, 700, 600, 602, 702	107	45	18	4
55.000.016	CCW	LH	559.032.10		107	45	18	4
55.000.004	CW	RH	561.513.00	FC 300, 302, 303, 350, 352, 400, 500, 4000G, 4000R, 4000RG	93	40	16.5	3
55.000.003	CCW	LH	561.512.00		93	40	16.5	3

NEW HOLLAND

BRABER#	ROTATION	HANDLE	NEW HOLLAND#	FITS MODELS	A	B	C	D
55.000.012	CW	RH	444 267		120	48	18.5	4
55.000.011	CCW	LH	444 266		120	48	18.5	4
55.000.015	CW	RH	853 820	408, 411, 412, 415	107	45	18	4
55.000.016	CCW	LH	853 819		107	45	18	4
55.000.683	CW	RH	9847683	1411, 1412, 1431, 1432, 1441, 1442 & OLDER 600 SERIES	107	48	22.8	4
55.000.684	CCW	LH	9847684		107	48	22.8	4

NEW IDEA

BRABER#	ROTATION	HANDLE	NEW IDEA#	FITS MODELS	A	B	C	D
55.000.011	CCW	LH	526215	5209, 5212, 526, 527, 528, 5406, 5407, 5408, 5409	120	48	18.5	4
55.000.012	CW	RH	526216		120	48	18.5	4

TAARUP

BRABER#	ROTATION	HANDLE	TAARUP#	FITS MODELS	A	B	C	D
55.110.400	CW	RH	56.110.400	4028, 4032, 4032C, 4040, 4040C	126	48	20.5 X 23	4
55.110.900	CCW	LH	56.110.900		126	48	20.5 X 23	4

VICON

BRABER#	ROTATION	HANDLE	VICON#	FITS MODELS	A	B	C	D
55.000.012	CW	RH	900-58-700	CH165, 167, 247, 240, GHR2400, 3200, KH240, 241, 321, KMR, KMT 2400, 300, 3200	120	48	18.5	4
55.000.011	CCW	LH	902-58-699		120	48	18.5	4
55.000.014	CW	RH	902-61-560	AM 2400, 2800, CM144, 216, 217, GMR 2800, KM 281, 391, KMR 2800, KMT 2800	108	48	18.5	4
55.000.013	CCW	LH	902-61-559		108	48	18.5	4

ALL MEASUREMENTS ARE IN MILLIMETERS UNLESS OTHERWISE STATED (1" = 25.4 MM)



BOLT & NUT

BRABER#	KUHN#	A	B	C	D
06.000.015	561.158.00K	12	18	12	26

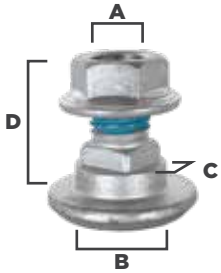

BOLT & NUT

BRABER#	FELLA#	A	B	C	D
06.000.016	122.181, 426.053	12	18	12	21



BOLT & NUT

BRABER#	TAARUP#	A	B	C	D
06.000.018	56.403.000	12	20	12	30



BOLT & NUT

BRABER#	VICON#	A	B	C	D
06.000.017	900-81-160	10	18	N/A	25

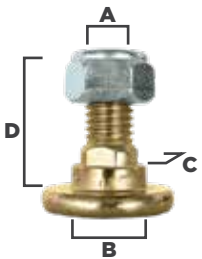

BOLT & NUT

BRABER#	VICON#	A	B	C	D
06.000.020	B13-74-593	12	18	12	29

DIMENSIONS LEGEND

A	BOLT WIDTH (MM)
B	BLADE SHOULDER (MM)
C	LOCK WIDTH (MM)
D	USABLE LENGTH (MM)

MOUNTS, HARROWS, BALE FORKS AND SLEEVES

CONUS TYPE CRANKED BALE SPEAR

60.000.006



PART#	60.000.006	60.000.007
LENGTH	35"	39"
LOAD	1800 LBS	2200 LBS
TYPE	CRANKED CONUS 1	CRANKED CONUS 2

39" CONUS TYPE BALE FORK

60.000.004



PART#	60.000.003	60.000.004	60.000.005
LENGTH	32"	39"	49"
LOAD CENTER	23.5": 3585 LBS	23.5": 3585 LBS	23.5": 3585 LBS
LOAD CAPACITY	31.5": 2600 LBS	31.5": 2600 LBS	31.5": 2600 LBS
TYPE	STRAIGHT CONUS 2	STRAIGHT CONUS 2	STRAIGHT CONUS 2

39" 3500 LB BALE SPEAR KIT

60.000.014



PART#	60.000.014	60.000.015
LENGTH	39"	49"
LOAD CAPACITY	3500 LBS	3500 LBS
TYPE	STRAIGHT CONUS 2	STRAIGHT CONUS 2

CONUS TYPE 1 SLEEVE

60.000.001



CONUS TYPE 2 SLEEVE

60.000.002



PART#	60.000.001	60.000.002
INSIDE DIAMETER	25.5 MM X 35.2 MM	31.8 MM X 44.5 MM
OUTSIDE DIAMETER	50.2 MM	118 MM
LENGTH	108 MM	57.3 MM
TYPE	CONUS 1 SLEEVE	CONUS 2 SLEEVE

BALE SPEAR RACK

60.000.010



***INCLUDES BALE SPEARS**

BALE SPEAR RACK INCLUDES

PART#	DESCRIPTION	QTY PER KIT
60.000.002	CONUS 2 SLEEVE	8
60.000.003	32" BALE SPEAR	2
60.000.004	39" BALE SPEAR	6
60.000.005	49" BALE SPEAR	8

CLASS IIA MOUNT BALE SPEAR

BE-PFBS39



PART #	BE-PFBS39	BE-PFBS49
TINE LENGTH	39"	49"
USABLE LENGTH	34"	44"
CAPACITY	2000 LBS	2000 LBS

FLAILS BLADES

PART#	DESCRIPTION
55.000.080	FL920 CUP FLAIL
55.000.090	FL940 HD SPF MOWERS
55.000.090HS	FL946 HARDENED SURFACE

FLAIL
PART# 55.000.090



FLAIL
PART# 55.000.080



FORGED HAMMER
REARS OM750, HARD SURFACED
55.000.099HS
Made In Italy



BOLT & NUT KIT #: 05.100.013

FORGED HAMMER
REARS OM750
55.000.099
Made In Italy



BOLT & NUT KIT #: 05.100.013

FORGED HAMMER
PERFECT
55.000.021
Made In Italy



BOLT & NUT KIT #: 05.100.003

FORGED HAMMER
SEPPI LONG
55.000.020
Made In Italy



FORGED HAMMER
SEPPI SHORT
55.000.022
Made In Italy



FORGED HAMMER
AGRIEASE AGF
EFAG140.103



FORGED HAMMER
AGRIEASE EFGC
EFGC120.104A



FORGED HAMMER
BOMFORD 02-959-01
55.000.026
Made In Italy



FORGED HAMMER
VOTEX
55.000.150
Made In Italy



FORGED HAMMER
REARS FL948
55.000.098
Made In Italy



FLAIL BLADES & HAMMERS

**FORGED HAMMER
FITS COSMAD/RINIERI/ZANON**
55.000.060
🇮🇹 Made In Italy



**FORGED HAMMER
TIGER**
55.296.763
🇮🇹 Made In Italy



**FORGED HAMMER
PROMAC**
55.128.000
🇮🇹 Made In Italy



**FORGED HAMMER
BOMFORD 42594-01**
55.425.941
🇮🇹 Made In Italy



**FORGED HAMMER
RINIERI TRB**
55.000.277
🇮🇹 Made In Italy



**FORGED HAMMER
MCCONNELL/BOMFORD**
55.500.000
🇮🇹 Made In Italy



**FORGED HAMMER
ALAMO16.5**
55.100.300
🇮🇹 Made In Italy



**FORGED HAMMER
MASCHIO GIRAFFA**
034-00-410
🇮🇹 Made In Italy



**RAKE TINE
FITS CESARI**
45.000.430
🇮🇹 Made In Italy



**FORGED HAMMER
WILLIBAUGH**
55.000.019
🇮🇹 Made In Italy



**FORGED HAMMER
FITS BE-AGL**
701140011



**RAKE TINE
FITS BORELLO**
45.000.410
🇮🇹 Made In Italy



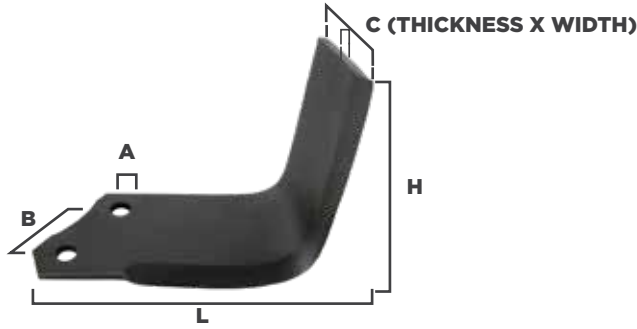

L SHAPED TILLAGE BLADES

THE SQUARE BLADE OR "L" BLADE CREATES A FINER FINISH FOR SEED BED PREPARATION AND CREATES MORE HARDPAN.

THE SQUARE BLADE HAS A CHOPPING EFFECT WHICH IS IDEAL FOR RASPBERRY CANES.

AGRIC

BRABER#	AFRIC#	FITS MODELS	BOLT KIT	A	B	C	L	H
63.000.009	LH	N/A	05.000.002	1/2"	57	80 X 7	180	132
63.000.010	RH	N/A						
63.000.013	LH	36216L	05.000.001	7/16"	57	80 X 6	170	140
63.000.014	RH	36215R						

BREVEGLIERI

BRABER #	BREVEGLIERI#	FITS MODELS	BOLT KIT	A	B	C	L	H
63.000.098	RH	0089275D	05.000.006	12.5	40	60 X 6	154	56
63.000.098HS								
63.000.099	LH	0089275S						
63.000.099HS								

FARM KING

BRABER#	FARM KING#	FITS MODELS	BOLT KIT	A	B	C	L	H
63.000.009	LH	91202901LH	05.000.002	1/2"	57	80 X 7	180	132
63.000.010	RH	91202900RH						

FRONTIER

BRABER#	FRONTIER#	FITS MODELS	BOLT KIT	A	B	C	L	H
63.000.047	LH	191-00-422	05.000.006	7/16"	45	70 X 6	190	115
63.000.046	RH	191-00-421						

HOWARD

BRABER#	HOWARD#	FITS MODELS	BOLT KIT	A	B	C	L	H
63.000.009	LH	3900	05.000.002	1/2"	57	80 X 7	180	132
63.000.010	RH	3901						
63.000.013	LH	9900	05.000.001	7/16"	57	80 X 6	170	140
63.000.014	RH	9901						
63.000.015	LH	9863	05.000.009 OPT: 05.000.008	16.5	51	80 X 9	180	138
63.000.016	RH	9862						

JOHN DEERE

BRABER#	JOHN DEERE#	FITS MODELS	BOLT KIT	A	B	C	L	H
63.000.009	LH	N/A	05.000.002	1/2"	57	80 X 7	180	132
63.000.010	RH	N/A						
63.000.013	LH	PT8444	05.000.001	7/16"	57	80 X 6	170	140
63.000.014	RH	PT8445						
63.000.064	LH	N/A	05.000.007	14.5	48	80 X 6	180	135
63.000.065	RH	N/A						

HS: HARD SURFACED ONE SIDE
TS: HARD SURFACED BOTH SIDES

ALL MEASUREMENTS ARE IN MILLIMETERS UNLESS OTHERWISE STATED (1" = 25.4 MM)
THESE ITEMS ARE NOT ORIGINAL EQUIPMENT PARTS

SQUARE BLADES / L BLADE

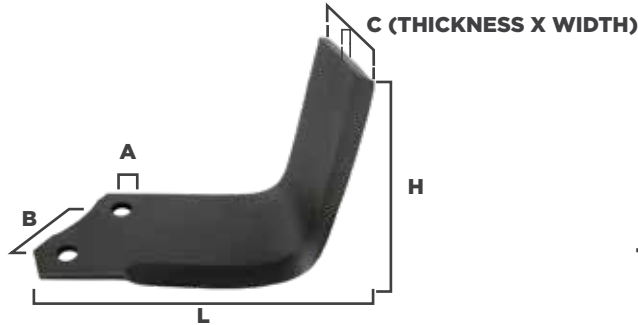

L SHAPED TILLAGE BLADES

THE SQUARE BLADE OR "L" BLADE CREATES A FINER FINISH FOR SEED BED PREPARATION AND CREATES MORE HARDPAN.

THE SQUARE BLADE HAS A CHOPPING EFFECT WHICH IS IDEAL FOR RASPBERRY CANES.

KRONE

BRABER#		KRONE#	FITS MODELS	BOLT KIT	A	B	C	L	H
63.000.001	LH	035-43-0	RE	05.000.007	14.5	35	65 X 7	190	128
63.000.002	RH	035-268-1							
63.000.005	LH	036-395-0	REVS	05.000.007	14.5	57	80 X 7	165	138
63.000.006	RH	036-273-0							
63.000.007	LH	107-269-0	RF	05.000.009	16.5	75	110 X 8	195	140
63.000.008	RH	107-083-0							

KUHN

BRABER#		KUHN#	FITS MODELS	BOLT KIT	A	B	C	L	H
63.000.009	LH	N/A	EL-70/80/120	05.000.002	1/2"	57	80 X 7	169	130
63.000.010	RH	N/A							
63.000.013	LH	52166400	EL-30/35/45/50/60/71	05.000.001	7/16"	57	80 X 6	170	140
63.000.014	RH	52106300							

KUBOTA

BRABER#		KUBOTA#	FITS MODELS	BOLT KIT	A	B	C	L	H
63.000.013	LH	70741-55850	FL 850/1000/1020/ 1021/ 1270/1271	05.000.001	7/16"	57	80 X 6	170	140
63.000.014	RH	70741-55860							

MASCHIO/TERRANOVA

BRABER#		MASCHIO#	FITS MODELS	BOLT KIT	A	B	C	L	H
63.000.034	RH	021-08-430	NC/PS/Z	05.000.007	14.5	56	80 X 6	180	135
63.000.035	LH	021-08-431							
63.000.040	RH	011-10-428	BI/B/C/SC TBI/TB/TC/TSC	05.000.007	14.5	56	80 X 8	215	140
63.000.040HS									
63.000.041	LH	011-10-429	A/E/H/KS/W TA/TE/TH/TKS/TW	05.000.006	12.5	44	70 X 6	190	115
63.000.041HS									
63.000.046	RH	191-00-422	S TS	05.000.008	16.5	56	90 X 8	223	145
63.000.047	LH	191-00-421							
63.000.056	RH	241-00-404	U/US/UZ TU/TUS/TUZ	05.000.007	14.5	48	80 X 6	180	135
63.000.057	LH	241-00-405							
63.000.064	LH	291-00-408	G	05.000.009	16.5	68	97 X 10	225	140
63.000.065	RH	291-00-407							
63.000.052	RH	201-00-414							
63.000.053	LH	201-00-415							

HS: HARD SURFACED ONE SIDE
TS: HARD SURFACED BOTH SIDES

ALL MEASUREMENTS ARE IN MILLIMETERS UNLESS OTHERWISE STATED (1" = 25.4 MM)
THESE ITEMS ARE NOT ORIGINAL EQUIPMENT PARTS



L SHAPED TILLAGE BLADES

THE SQUARE BLADE OR "L" BLADE CREATES A FINER FINISH FOR SEED BED PREPARATION AND CREATES MORE HARDPAN.

THE SQUARE BLADE HAS A CHOPPING EFFECT WHICH IS IDEAL FOR RASPBERRY CANES.

NORTHWEST

NORTHWEST#		NORTHWEST#	FITS MODELS	BOLT KIT	A	B	C	L	H
63.100.026	LH	RB26		05.000.009	16.5	56	3/8"	167	157
63.100.026HS		RB26HS							
63.100.027	RH	RB27							
63.100.027HS		RB27HS							

ORTOLAN

BRABER#		ORTOLAN#	FITS MODELS	BOLT KIT	A	B	C	L	H
63.000.041	LH	63.000.041	H/P	05.000.007	14.5	56	80 X 8	215	140
63.000.041HS		63.000.041HS							
63.000.040	RH	63.000.040							
63.000.040HS		63.000.040HS							

SOVEMA

BRABER#		SOVEMA#	FITS MODELS	BOLT KIT	A	B	C	L	H
63.000.162	RH	900-11-007	SP/SPS/SE/SEC/SPC	05.000.006	12.5	46	70 X 7	180	110
63.000.163	LH	900-11-008							

HS: HARD SURFACED ONE SIDE
 TS: HARD SURFACED BOTH SIDES

ALL MEASUREMENTS ARE IN MILLIMETERS UNLESS OTHERWISE STATED (1" = 25.4 MM)
 THESE ITEMS ARE NOT ORIGINAL EQUIPMENT PARTS

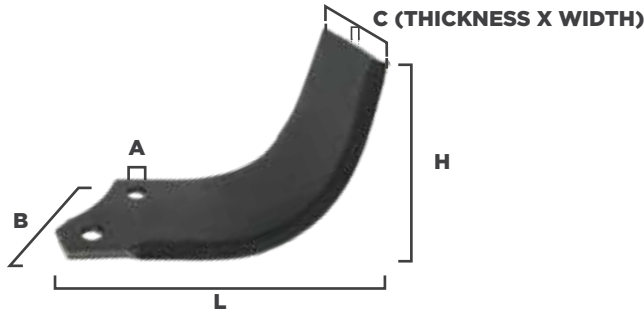

C SHAPED TILLAGE BLADES

THE "C" BLADE IS A GENERAL PURPOSE TILLAGE BLADE THAT CREATES LESS HARDPAN.
C BLADES HAVE A SELF CLEANING CAPABILITY DUE TO A WIPING MOTION.

AGRIEASE

BRABER#		FITS MODELS	BOLT KIT	A	B	C	L	H	
63.000.019	LH	63.000.019	BE-IGN	05.000.002	1/2"	57	80 X 7	210	130
63.000.020	RH	63.000.020							
63.000.048	RH	63.000.048	BE-TS	05.000.006	12.5	44	70 X 6	190	115
63.000.049	LH	63.000.049							
63.000.066	RH	63.000.066	BE-FTL	05.000.006	12.5	45	60 X 5.5	180	117
63.000.067	LH	63.000.067							
63.000.192	RH	63.000.192	BE-RT/RTM	05.000.006	12.5	44	65 X 6	165	105
63.000.193	LH	63.000.193							
63.000.194	RH	63.000.194	BE-RT	05.000.006	12.5	44	52 X 6	165	105
63.000.195	LH	63.000.195							
63.000.196	RH	63.000.196	BE-TXG	05.000.006	12.5	35	60 X 6	155	130
63.000.197	LH	63.000.197							

AGRIC

BRABER#		AGRIC#	FITS MODELS	BOLT KIT	A	B	C	L	H
63.000.019	LH	N/A	B, BMS	05.000.002	1/2"	57	80 X 7	210	130
63.000.020	RH	N/A							
63.000.073	LH	N/A	D/AFMJ/AL	05.000.001	7/16"	35	67 X 6	140	146
63.000.072	RH	N/A							

BEFCO

BRABER#		BEFCO#	FITS MODELS	BOLT KIT	A	B	C	L	H
63.000.121	LH	000-0104D/S	G/1/T30/T40	05.000.002	1/2"	40	60 X 6	175	110
63.000.120	RH	000-0104D/S							

CARONI

BRABER#		CARONI#	FITS MODELS	BOLT KIT	A	B	C	L	H
63.000.073	LH	FL-17400/500	FL80/90/100/110 /120/130	05.000.001	7/16"	35	67 X 6	140	146
63.000.072	RH	FL-17400/500							

CELLI

BRABER#		CELLI#	FITS MODELS	BOLT KIT	A	B	C	L	H
63.722.562HS		722562HS	TIGRE		16	57	71 X 10	176	142
63.722.562TS		722562TS							
63.722.563HS		722563HS	TIGRE		16	57	71 X 10	176	142
63.722.563TS		722563TS							

FARM KING

BRABER#		FARM KING#	FITS MODELS	BOLT KIT	A	B	C	L	H
63.000.019	LH	N/A	HD 50/60/72/84/E50	05.000.002	1/2"	57	80 X 7	210	130
63.000.020	RH	N/A							
63.000.121	LH	N/A	LD 40/48/60	05.000.002	1/2"	40	60 X 6	175	110
63.000.120	RH	N/A							

HS: HARD SURFACED ONE SIDE
TS: HARD SURFACED BOTH SIDES

ALL MEASUREMENTS ARE IN MILLIMETERS UNLESS OTHERWISE STATED (1" = 25.4 MM)
THESE ITEMS ARE NOT ORIGINAL EQUIPMENT PARTS

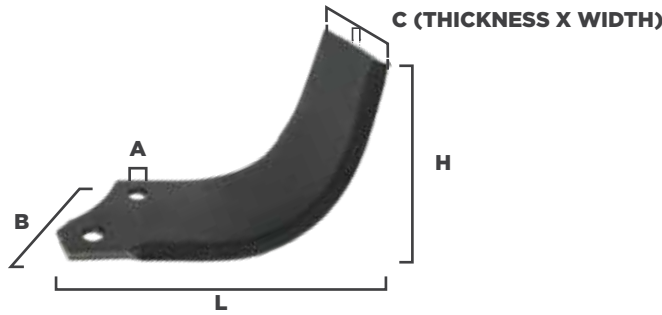

C SHAPED TILLAGE BLADES

THE "C" BLADE IS A GENERAL PURPOSE TILLAGE BLADE THAT CREATES LESS HARDPAN.
C BLADES HAVE A SELF CLEANING CAPABILITY DUE TO A WIPING MOTION.

FRONTIER

BRABER#		FRONTIER#	FITS MODELS	BOLT KIT	A	B	C	L	H
63.000.069	LH	400-00-405	RT 1140/1150/1160H	05.000.006	12.5	40	60 X 5	180	110
63.000.068	RH	400-00-404							
63.000.067	LH	480-00-405	RT 1240/1250/1160	05.000.006	12.5	45	60 X 5.5	180	117
63.000.066	RH	480-00-404							
63.000.049	LH	191-00-424	RT 1260/1360	05.000.006	12.5	44	70 X 6	190	115
63.000.049HS									
63.000.048	RH	191-00-423							
63.000.048HS									

HOWARD

BRABER#		HOWARD#	FITS MODELS	BOLT KIT	A	B	C	L	H
63.000.019	LH	9948	E/U/HE/A/H/ST/HR20/ HR30/ E50	05.000.002	1/2"	57	80 X 7	210	130
63.000.020	RH	9949							
63.000.609	LH	G5149/300	HR7/HR12	05.000.001	7/16"	35	60 X 6	130	120
63.000.610	RH	D5150/300							

JOHN DEERE

BRABER#		JOHN DEERE#	FITS MODELS	BOLT KIT	A	B	C	L	H
63.000.019	LH	N/A	770	05.000.002	1/2"	57	80 X 7	210	130
63.000.020	RH	N/A							
63.000.609	LH	N/A	550/660	05.000.001	7/16"	35	60 X 6	130	120
63.000.610	RH	N/A							

KUHN

BRABER#		KUHN#	FITS MODELS	BOLT KIT	A	B	C	L	H
63.000.096HS	RH	52359600	GL 142/250/300/400	05.000.008	16	75	108 X 8	225	140
63.000.097HS	LH	52359700							

LANDPRIDE

BRABER#		LANDPRIDE#	FITS MODELS	BOLT KIT	A	B	C	L	H
63.000.121	LH	820-056C	10/15	05.000.002	1/2"	40	60 X 6	175	110
63.000.120	RH	820-055C							
63.000.185	LH	820-057C	25	05.000.002	1/2"	1-3/4"	60 X 6	190	115
63.000.184	RH	820-058C							
63.000.049	LH		34/50	05.000.006	12.5	44	70 X 6	190	115
63.000.049HS									
63.000.048	RH								
63.000.048HS									

MALETTI

BRABER#		MALETTI#	FITS MODELS	BOLT KIT	A	B	C	L	H
63.000.150	LH	1300079C	PL	05.000.007	14.5	46	70 X 8	205	110
63.000.151	RH	1300080C							

HS: HARD SURFACED ONE SIDE
TS: HARD SURFACED BOTH SIDES

ALL MEASUREMENTS ARE IN MILLIMETERS UNLESS OTHERWISE STATED (1" = 25.4 MM)
THESE ITEMS ARE NOT ORIGINAL EQUIPMENT PARTS

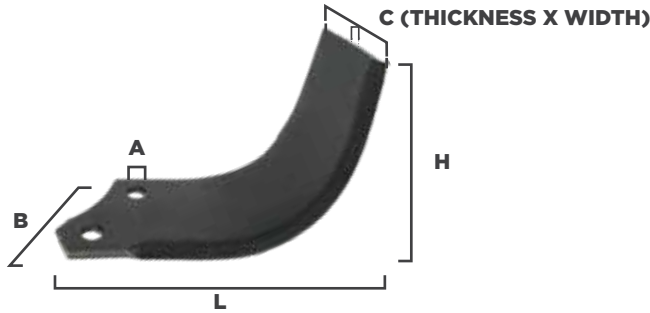

C SHAPED TILLAGE BLADES

THE "C" BLADE IS A GENERAL PURPOSE TILLAGE BLADE THAT CREATES LESS HARDPAN. C BLADES HAVE A SELF CLEANING CAPABILITY DUE TO A WIPING MOTION.

MASCHIO/TERRANOVA

BRABER#	MASCHIO#	FITS MODELS	BOLT KIT	A	B	C	L	H	
63.000.069	LH	40000404/5	L TL	05.000.006	12.5	40	60 X 5	180	110
63.000.068	RH	40000404/5							
63.000.033	LH	005-66-103/153	R/L (OLD STYLE)	05.000.006	12.5	65	60 X 6	195	83
63.000.032	RH	005-66-103/153							
63.000.037	LH	021-08-433	NC/PS/Z TN/TP/TZ	05.000.007	14.5	56	80 X 6	192	135
63.000.036	RH	021-08-432							
63.000.050	LH	201-00-413	G TG	05.000.009	16	68	90 X 10	265	145
63.000.050HS									
63.000.051	RH	201-00-412							
63.000.051HS									
63.000.055	LH	211-00-413	K TK	05.000.005	10.5	56	60 X 6	174	57
63.000.055HS									
63.000.054	RH	211-00-412							
63.000.054HS									
63.000.062	LH	291-00-405	U/US/UZ TU/TUS/TUZ	05.000.007	14.5	48	80 X 6	160	132
63.000.063	RH	291-00-406							
63.000.066	LH	480-00-404	W/TW OLD STYLE	05.000.006	12.5	45	60 X 5.5	180	117
63.000.067	RH	480-00-405							
63.000.068	RH	731-00-404	W/TW NEW STYLE	05.000.006	12.5	60	60 X 6	178	117
63.000.069	LH	731-00-405							
63.000.049	LH	191-00-424	A/E/H/KS/AL TA/TE/TKS	05.000.006	12.5	44	70 X 6	190	115
63.000.048	RH	191-00-423							
63.000.039	LH	011-10-427	BI/B/C/AS/SC TBI/TB/TC/TSC	05.000.007	14.5	56	80 X 8	215	142
63.000.039HS									
63.000.038	RH	011-10-426							
63.000.038HS									
63.000.414	RH	094-00-414	NEW STYLE PANTERA	05.000.008	16	56	90 X 10	175	150
63.000.415	LH	094-00-415							
63.000.414TS	RH	094-00-423							
63.000.415TS	LH	094-00-424							

MULTIVATOR

BRABER#	MULTIVATOR#	FITS MODELS	BOLT KIT	A	B	C	L	H	
63.000.075	LH	185L / 185LH	FP6	05.000.005	10.5	31.5	55 X 6	150	54
63.000.075HS									
63.000.074	RH	184R / 184LH	FPSR	05.000.006	12.5	40	65 X 6	170	70
63.000.074HS									
63.000.077	LH	FPSL / FPSLH	FPSR	05.000.006	12.5	40	65 X 6	170	70
63.000.077HS									
63.000.078	RH	FPSR / FPSRH	FPSR	05.000.006	12.5	40	65 X 6	170	70
63.000.078HS									

HS: HARD SURFACED ONE SIDE
TS: HARD SURFACED BOTH SIDES

ALL MEASUREMENTS ARE IN MILLIMETERS UNLESS OTHERWISE STATED (1" = 25.4 MM)
THESE ITEMS ARE NOT ORIGINAL EQUIPMENT PARTS

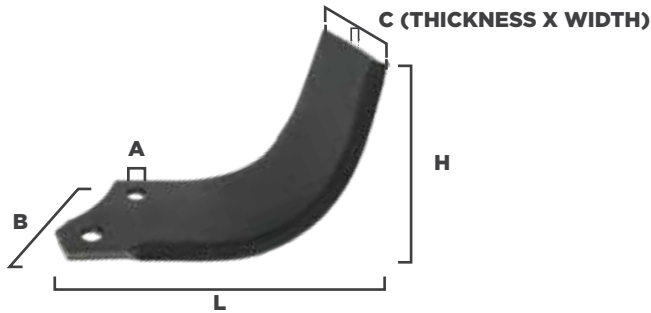

**C SHAPED
TILLAGE BLADES**
 THE "C" BLADE IS A GENERAL PURPOSE
 TILLAGE BLADE THAT CREATES LESS HARDPAN.
 C BLADES HAVE A SELF CLEANING
 CAPABILITY DUE TO A WIPING MOTION.

NORTHWEST

BRABER#		NORTHWEST#	FITS MODELS	BOLT KIT	A	B	C	L	H
63.100.039HS	LH	RB39L	SABRE	05.000.011	16.5	56	98 X 10	130	100
63.100.040HS	RH	RB40R							

OROTLAN

BRABER#		OROTLAN#	FITS MODELS	BOLT KIT	A	B	C	L	H
63.000.033	LH	566153	L/S	05.000.006	12.5	65	60 X 6	195	83
63.000.032	RH	566103							
63.000.039	LH	N/A	H/P	05.000.007	14.5	56	80 X 8	215	142
63.000.038	RH	N/A							

SICMA

BRABER#		SICMA#	FITS MODELS	BOLT KIT	A	B	C	L	H
63.000.121	LH	4811680	SA	05.000.002	12.5	40	60 X 6	175	110
63.000.120	RH	4811681							
63.000.039	LH	4814783	SP	05.000.007	14.5	56	80 X 8	215	142
63.000.038	RH	4814784							

YANMAR

BRABER#		YANMAR#	FITS MODELS	BOLT KIT	A	B	C	L	H
63.000.033	LH	412129	YKT/YHT-60	05.000.006	12.5	65	60 X 6	195	83
63.000.032	RH	412130							

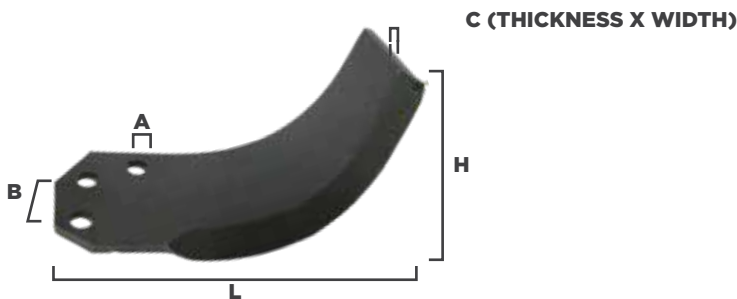

CARRARO

BRABER#		CARRARO#	FITS MODELS	BOLT KIT	A	B	C	L	H
63.000.092	LH	98712	28/29 (3 HOLE)	05.000.006	12.5	57-34	80 X 7	182	130
63.000.093	RH	98713							

HS: HARD SURFACED ONE SIDE
 TS: HARD SURFACED BOTH SIDES

ALL MEASUREMENTS ARE IN MILLIMETERS UNLESS OTHERWISE STATED (1" = 25.4 MM)
 THESE ITEMS ARE NOT ORIGINAL EQUIPMENT PARTS



J SHAPED TILLAGE BLADES

THE "J" BLADE IS A GENERAL PURPOSE TILLAGE BLADE THAT CREATES LESS HARDPAN. J BLADES HAVE A SELF CLEANING CAPABILITY DUE TO A WIPING MOTION.

KRONE

BRABER#		KRONE#	FITS MODELS	BOLT KIT	A	B	C	L	H
63.000.003	LH	034-109-0	RL	05.000.006	12.5	120	40 X 8	268	102
63.000.004	RH	034-020-0							

MURATORI

BRABER#		MURATORI#	FITS MODELS	BOLT KIT	A	B	C	L	H
63.000.140	LH	57	MA	05.000.006	12.5	123	60 X 6	275	120
60.000.141	RH	65							

* WHILE SUPPLIES LAST

QUICK FIT BLADES



MASCHIO

BRABER#			MASCHIO#	FITS MODELS	A	L	H
63.000.366	LH	CW	361-00-366	MEGA/ JUMBO/ DM/ AQUILA	15	320	110
63.000.367	RH	CCW	361-00-367				

POWER HARROW BLADES



MASCHIO

BRABER#			MASCHIO#	FITS MODELS	BOLT KIT	A	B	C	L	H
63.000.061	LH	CW	271-00-209	DL/DC/DS/ TD/TDL/TDC/TDS	04.016.050 GRADE 10.9	16.5	50	90 X 10	280	101
63.000.060	RH	CCW	271-00-210							
63.000.170	LH	CW	361-00-210	DM/TDM	04.016.050, 04.016.065SPC OR 04.016.055	16.5	60	100 X 12	300	101
63.000.171	RH	CCW	361-00-211							
63.000.172	LH	CW	611-00-229	MEGA	04.018.059 GRADE 10.9	18.5	70	110 X 15	320	110
63.000.173	RH	CCW	611-00-230							

ROTO SPIKE BLADES



MASCHIO

BRABER#			MASCHIO#	FITS MODELS	BOLT KIT	A	B	C	L
63.000.070	LH		261-00-417	MASCHIO COBRA/SUPER COBRA/ FALCON/SUPER FALCON	05.000.007	14.5	44	80 X 8	185
63.000.071	RH		261-00-418						

HS: HARD SURFACED ONE SIDE
TS: HARD SURFACED BOTH SIDES

ALL MEASUREMENTS ARE IN MILLIMETERS UNLESS OTHERWISE STATED (1" = 25.4 MM)
THESE ITEMS ARE NOT ORIGINAL EQUIPMENT PARTS

POWER HARROW SPIKES

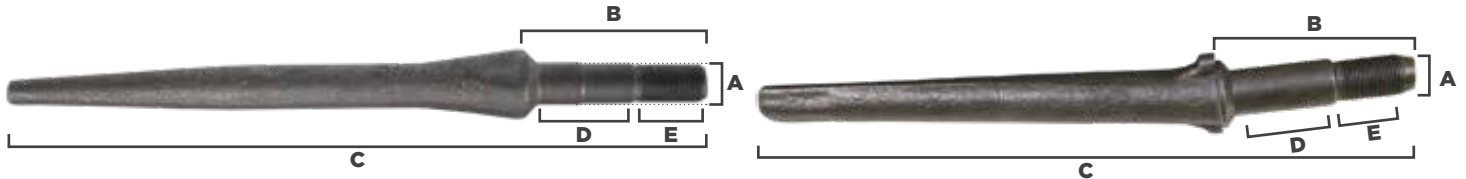

VICON

BRABER#	VICON#	FITS MODELS	NUT	WASHER	A	B	C	D	E
63.000.076	900-44-100	SE2-300/450	305-69-910	314-55-910	20	93	365	48	38

LELY

BRABER#	LELY#	SUPPORTING NUT	SUPPORTING WASHER	A	B	C	D	E
63.000.024	1160603150	305-69-910*	314-55-910*	20 X 1.5	95	365	60	32

BOLT ASSEMBLIES

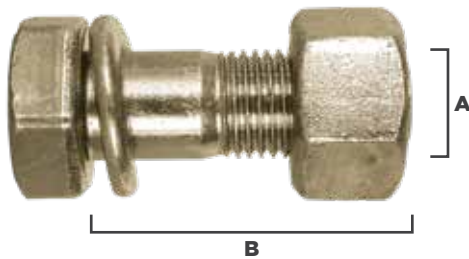

TILLER BOLT ASSEMBLIES

BRABER#	MODELS	A	B	GRADE
05.000.001	HOWARD P, KUHN BL30/35/45, YANMAR YMT/YHT50, AGRIC A, TILLIT LTD/MTD, KUBOTA FL TILLER	7/16"	1-3/8"	10.9
05.000.002	HOWARD E, DOUGLAS HD 50/60, KUHN EL70/120, LANDPRIDE	1/2"	1-1/2"	10.9
05.000.005	MASCHIO K, TERRANOVA TK, CARONI FL, MEARELLI FP, SOVEMA LASER	10	30	8.8
05.000.006	MASCHIO A/E/R/KS/W, TERRANOVA TA/TE/KS/W, MP TL/TLS, PEGORARO TL/TLS	12	35	10.9
05.000.007	MASCHIO BI/B/N/P/Z/C/SC/US/UZ TERRANOVA TB/TN/TP/TZ/TC/TSC/TB1 KUHN EL-80, MALLETTI, ORTOLAN 45H/P, SOVEMA SE/SECS/SE/S, LANDPRIDE 35, PEGORARO DL/LN, MURATORI MH/MHC	14	40	10.9
05.000.008	MASCHIO S/G, TERRANOVA TS/TG, HOWARD S	16	45	8.8
05.000.009	MASCHIO S/G/D, TERRANOVA TS/TG/TD, NORTHWEST	16	60	10.9
05.000.010	MASCHIO L/HB/HM, TERRANOVA TL/TH/TM, KUHN EL25, CARRARO 27/28/29, DOUGLAS LD-40/48/60, YANMAR YKT/YHT-60, MUROTOR MA, LANDPRIDE 25/1550, SOVEMA SP/SPS/SE/SEC/SPC	12	45	8.8
05.000.011	NORTHWEST SABRE	16	5	10.9
05.000.012	NORTHWEST SABRE	14	35	8.8

HS: HARD SURFACED ONE SIDE
TS: HARD SURFACED BOTH SIDES

ALL MEASUREMENTS ARE IN MILLIMETERS UNLESS OTHERWISE STATED (1" = 25.4 MM)
THESE ITEMS ARE NOT ORIGINAL EQUIPMENT PARTS

Xstream[®] hi-flex

HYBRID PVC MATERIAL IS LIGHTWEIGHT AND FLEXIBLE
STAYS FLEXIBLE IN COLD WEATHER UP TO -40°
KINK RESISTANT
LAYS FLAT AND EASY TO COIL

50' HIGH FLEXIBILITY GARDEN HOSE
HIGH FLEX POLYMER



PART#	90.358.051	90.375.051	90.375.101
SIZE	5/8" X 50'	3/4" X 50'	3/4" X 100'
COLOR	GREY	GREY	GREY

GARDEN HOSES & ACCESSORIES

350 PSI "EASY" SPRAY GUN
HEAVY DUTY INDUSTRIAL
CONSTRUCTION
350 PSI RATING
85.205.020



LOCKING OPERATION

**GARDEN HOSE ADJUSTABLE
BRASS GUN**
ADJUSTABLE BRASS NOZZLE
90.300.010



**GARDEN HOSE
MULTI-HEAD GUN**
8 SPRAY PATTERNS
90.300.011



GARDEN HOSE BRASS 4" NOZZLE
ADJUSTABLE BRASS NOZZLE
90.300.012



GARDEN HOSE BRASS VALVE
BRASS 2 WAY Y SPLITTER
WITH SWIVEL FITTING
91.900.073



GARDEN HOSE BRASS VALVE
INLINE BRASS HOSE SHUT OFF
91.900.074



GARDEN HOSE BRASS VALVE
HEAVY DUTY INLINE BRASS SHUT OFF
91.900.073



GARDEN HOSE SINGLE VALVE
NYLON INLINE SHUT OFF
GHV-1



GARDEN HOSE DOUBLE VALVE
NYLON 2 WAY Y SPLITTER
GHV-2





***ALL SPRAY NOZZLES COME WITH REMOVABLE QUICK COUPLER INSERT**



SPRAY GUN
SX-31001

- With 9" wand
- 8 Spray patterns, flow Control, soft Touch Trigger
- Rear flow control with variable flow from 50%-100%



ERGONOMIC LOCK-IN-PLACE THUMB CONTROL TRIGGER



ERGONOMIC LOCK-IN-PLACE THUMB CONTROL TRIGGER

SPRAY GUN
SX-21002

- 8 Spray patterns, flow control, soft touch trigger
- Rear flow control with variable flow from 50%-100%



ERGONOMIC LOCK-IN-PLACE THUMB CONTROL TRIGGER

SPRAY GUN
SX-21003

- 3 Spray patterns, flow control, soft touch trigger
- Rear flow control with variable flow from 50%-100%



REAR HANDLE SPRAY GUN
SX-21004

- 3 Spray patterns, flow control, soft touch trigger
- Rear flow control with variable flow from 50%-100%



1 & 2 LITER COMMERCIAL HANDHELD SPRAYERS

LOCKABLE HANDLE FOR CONTINUOUS SPRAY

ERGONOMIC HANDLE

LIGHTWEIGHT & EASY TO USE

HANDLE ACTION PUMP

BRASS CONICAL SPRAY TIP

LARGE MOUTH FOR EASY FILLING



PART #	90.704.001	90.704.002
CAPACITY	1 LITER / 1 QUART	2 LITER / 2 QUART

4, 6 & 8 LITER COMMERCIAL HANDHELD SPRAYERS

LANCE CLIP

ERGONOMIC HANDLE

LARGE MOUTH FOR EASY FILLING

COMMERCIAL GRADE BUNA SEALS

AIR BLEEDER VALVE

SERVICEABLE LANCE

ADJUSTABLE CARRY STRAP

IMPACT RESISTANT POLYMER



PART #	90.704.004	90.704.006	90.704.008
CAPACITY	4 LITER / 1 GALLON	6 LITER / 1-1/2" GALLON	8 LITER / 2 GALLON

**8 & 12 LITER INDUSTRIAL
HANDHELD SPRAYERS**

VITON™ SEALS

OFFER A WIDE RANGE OF CHEMICAL RESISTANCES AND DO NOT DEGRADE QUICKLY FROM EITHER WEATHER, OZONE OR UV EXPOSURE.

VITON™ SEALS ARE AN EXCELLENT OPTION FOR MOST APPLICATIONS INVOLVING OILS, FUELS, AND MINERAL ACIDS.

VITON™ SEALS OFFER EXCELLENT COMPRESSION RESISTANCE AND ARE DESIGNED TO RESIST MOST OILS AND LUBRICANTS - ESPECIALLY PETROLEUM-BASED LUBRICANTS.

HOWEVER, VITON™ SEALS ARE LESS RESISTANT TO ABRASIONS AND TEARS. BECAUSE OF THIS, VITON™ SEALS CAN BE USED IN AN EXTENSIVE LIST OF DIVERSE APPLICATIONS.

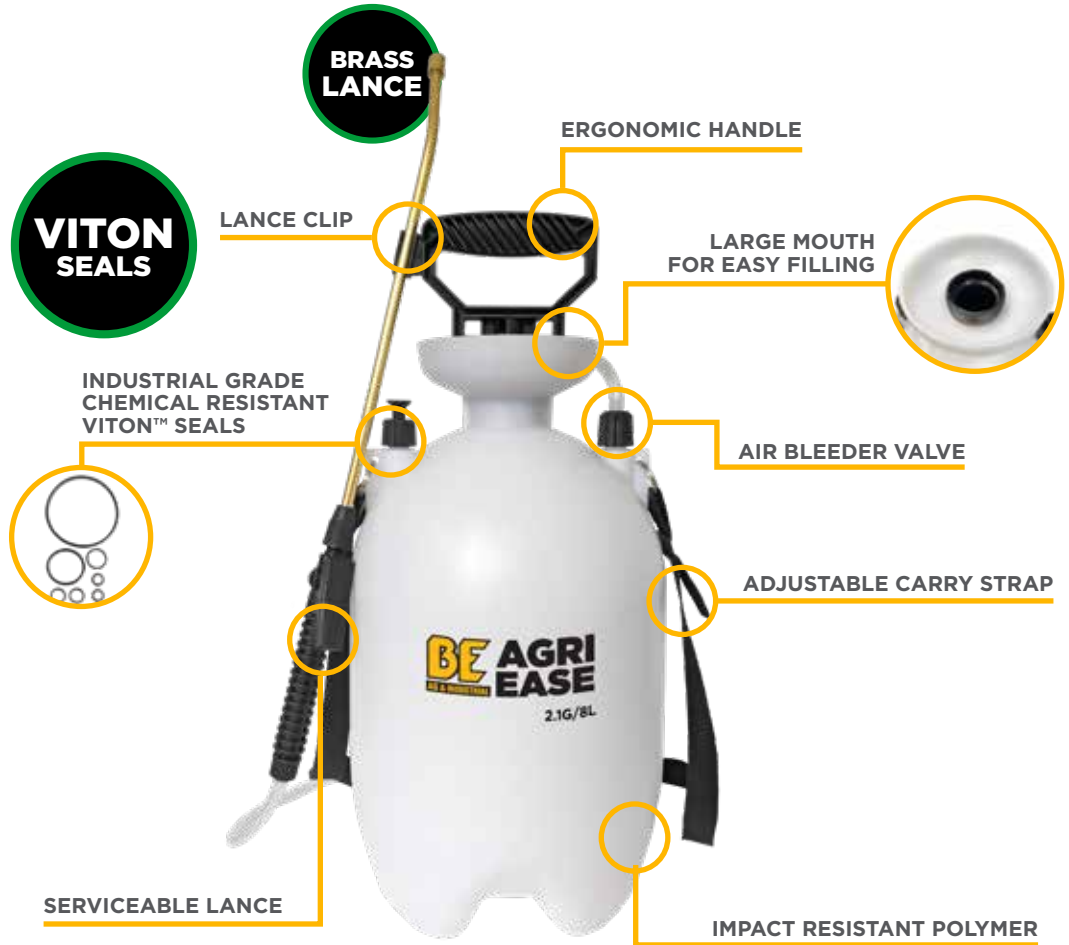

PART #	90.703.008	90.703.012
CAPACITY	8 LITER / 2 GALLON	12 LITER / 3 GALLON

16 LITER / 4 GALLON INDUSTRIAL BACKPACK SPRAYER

90.704.016



4 SPRAY TIPS INCLUDED

FLAT FAN SPRAY TIP



CONICAL SPRAY TIP



4-HOLE ADJUSTABLE SPRAY TIP



DUAL CONICAL SPRAY TIP



16 LITER / 4 GALLON INDUSTRIAL PORTABLE SPRAYER

90.710.016

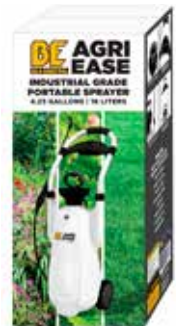



**16 LITER LITHIUM-ION
BACK PACK & PULL-BEHIND SPRAYER**
90.709.016

- Quick charger and slow charger with electronic protection
- Lithium-ion battery pack
- On/off switch prevents back flow
- Electronic overload protection

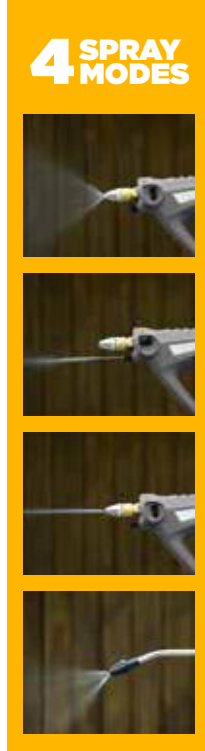

**OPERATOR CAN CHOOSE
BACKPACK OR PULLING BEHIND**



RETAIL BOXED	BUNA SEALS	2.5 HR CHARGE TIME	200 MIN RUN TIME	7.2V LITHIUM-ION POWERED
---------------------	-------------------	---------------------------	-------------------------	---------------------------------

**34 LITER / 9 GALLON
SPOT SPRAYER**
90.700.100



**34 LITER / 9 GALLON
LITHIUM ION
TURF SPRAYER**
90.709.014

**14.4V
LITHIUM
ION**



**14.4 VOLT
LITHIUM ION
BATTERY FOR LONG
LASTING POWER**



**REMOVABLE BAR FOR
TOWING BEHIND
ATV OR RIDE ONS**



**1.0 GPM EVERFLO
PUMP FOR
CONTINUOUS FLOW**



15 & 25 GALLON SPOT SPRAYERS
15' HOSE WITH U45050000 GUN,
1.0 GPM 12 VOLT PUMP

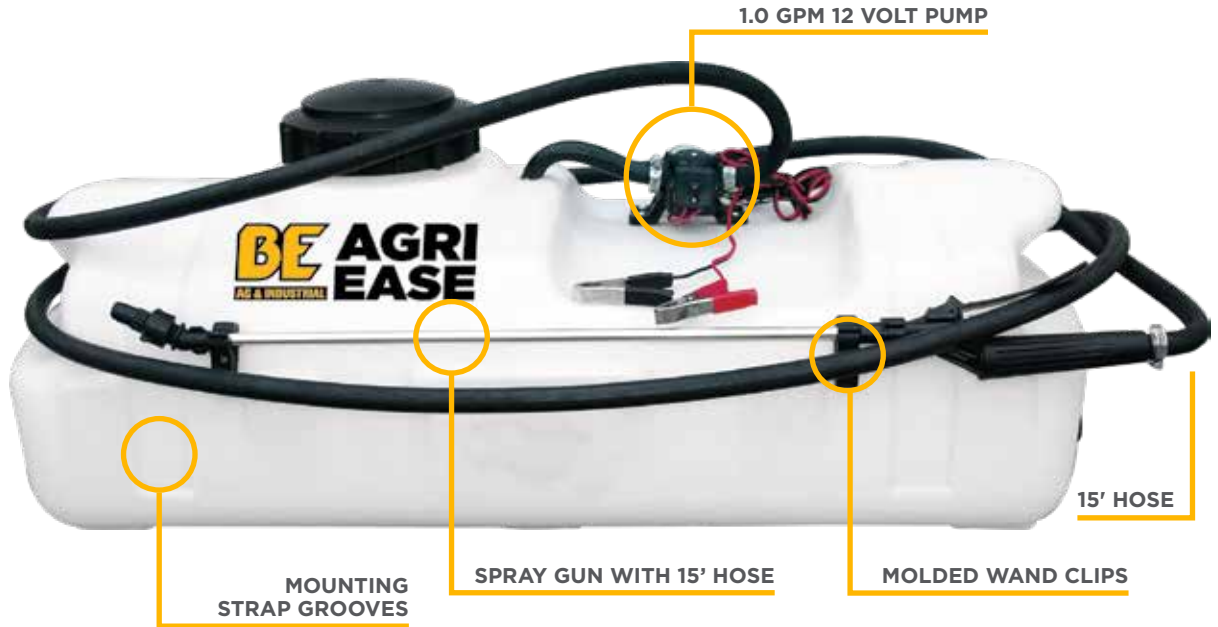

OPTIONAL ACCESSORIES

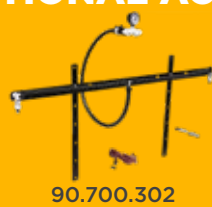

PART #	90.700.150	90.700.250
CAPACITY	15 GALLON	25 GALLON
PUMP	DELANVAN 1.0 GPM, 12V	DELANVAN 1.0 GPM, 12V

REPLACEMENT WEAR PARTS

PUMP	90.220.201	90.220.201
------	------------	------------

OPTIONAL ACCESSORIES

PART#	DESCRIPTION
90.700.302	STRAIGHT BOOM, 2 NOZZLES USE WITH A MIN 1.8 GPM PUMP*
90.700.303	BRACKET KIT FOR ATV, SINGLE
90.700.306	BOOMLESS NOZZLE KIT, SINGLE

15 GALLON REPLACEMENT TANK
90.700.155



25 GALLON ATV SPRAYER
INCLUDES TANK, ATV MOUNT & BOOM



PART #	90.712.250	90.713.250
CAPACITY	25 GALLON	25 GALLON
BOOM	2 NOZZLE FIXED	3 NOZZLE FOLDING
BOOM SPRAY COVERAGE	7'	10'

REPLACEMENT WEAR PARTS

PUMP	90.241.220	90.241.220
------	------------	------------

- 5" Fill lid with tether
- Glyphosate compatible
- Adjustable flow control & pressure gauge
- Adjustable pressure with return to tank
- Adjustable brackets for perfect boom height
- Adjustable cone spray nozzle
- 1 year warranty on manufacturing defects on pump and components

15 & 25 GALLON TRAILER SPRAYER



OPTIONAL SPRAY BOOMS



PART #	90.800.150	90.800.250
CAPACITY	15 GALLON	25 GALLON

REPLACEMENT WEAR PARTS

PUMP	90.780.230	90.241.220
------	------------	------------

OPTIONAL SPRAY BOOMS

PART#	DESCRIPTION
90.700.304	FOLDING BOOM KIT, 10' COVERAGE 3 NOZZLE
90.700.314	FOLDING BOOM, 4 NOZZLES, 14' COVERAGE USE WITH MIN 1.8 GPM PUMP
90.700.306	BOOMLESS NOZZLE KIT, SINGLE
90.700.307	BOOMLESS NOZZLE KIT, DOUBLE



**40 GALLON
TRAILER SPRAYER**

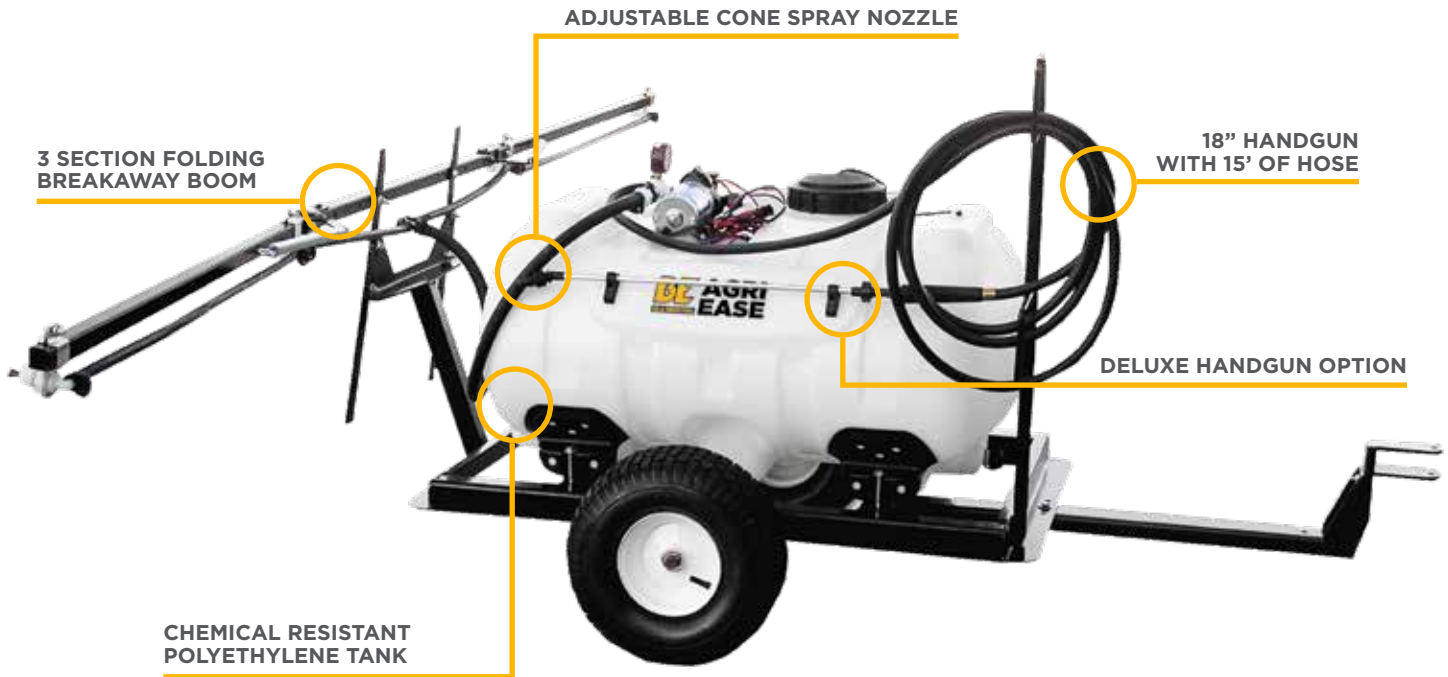

ALL MODELS INCLUDE:

**PUMP
FLOW CONTROL VALVE
SPOT GUN
& BOOM**

 BOXED	 BUNA SEALS	 MINOR ASSEMBLY	 10' BOOM SPRAY COVERAGE
--	--	--	---

PART #	90.800.400
CAPACITY	40 GALLON
BOOM SPRAY COVERAGE	10'

- On-Off boom control
- Adjustable pressure with return to tank
- Glyphosate compatible

REPLACEMENT WEAR PARTS

PUMP	90.241.220
REPLACEMENT TIP	90.140.025

40 GALLON 3 POINT SPRAYERS

ALL MODELS INCLUDE:
PUMP
FLOW CONTROL
VALVE
SPOT GUN
& BOOM



PRESSURE CONTROL & GAUGE

HANDGUN WITH 15' HOSE

3 POINT FRAME

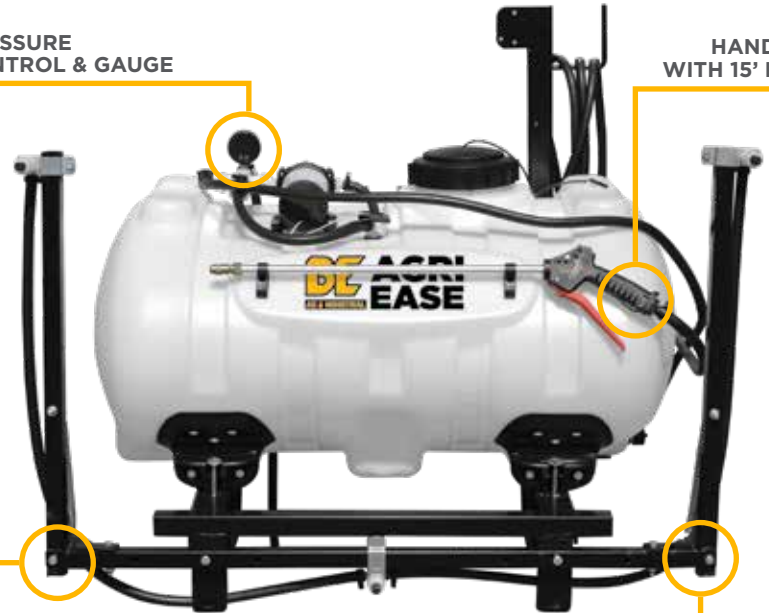

FOLDING BOOM SPRAYER WITH 10' SPRAY COVERAGE

PART #	BE-RMES40	BE-RMS40
CAPACITY	40 GALLON	40 GALLON
PUMP	12V PUMP	ROLLER PUMP

REPLACEMENT PARTS

PUMP	90.240.220	6900C
------	------------	-------

60 GALLON 3 POINT SPRAYERS

ALL MODELS INCLUDE:
PUMP
FLOW CONTROL
VALVE
SPOT GUN
& BOOM



PRESSURE CONTROL & GAUGE

HANDGUN WITH 15' HOSE

3 POINT FRAME



3 SECTION, 3 NOZZLE FOLDING BOOM WITH 10' SPRAY COVERAGE

PART #	BE-RMES60	BE-RMS60
CAPACITY	60 GALLON	60 GALLON
PUMP	12V PUMP	ROLLER PUMP

REPLACEMENT WEAR PARTS

PUMP	90.240.220	6900C
------	------------	-------

**40 & 60 GALLON
RTV MOUNT SPRAYER
WITH BOOM AND SPOT WAND**

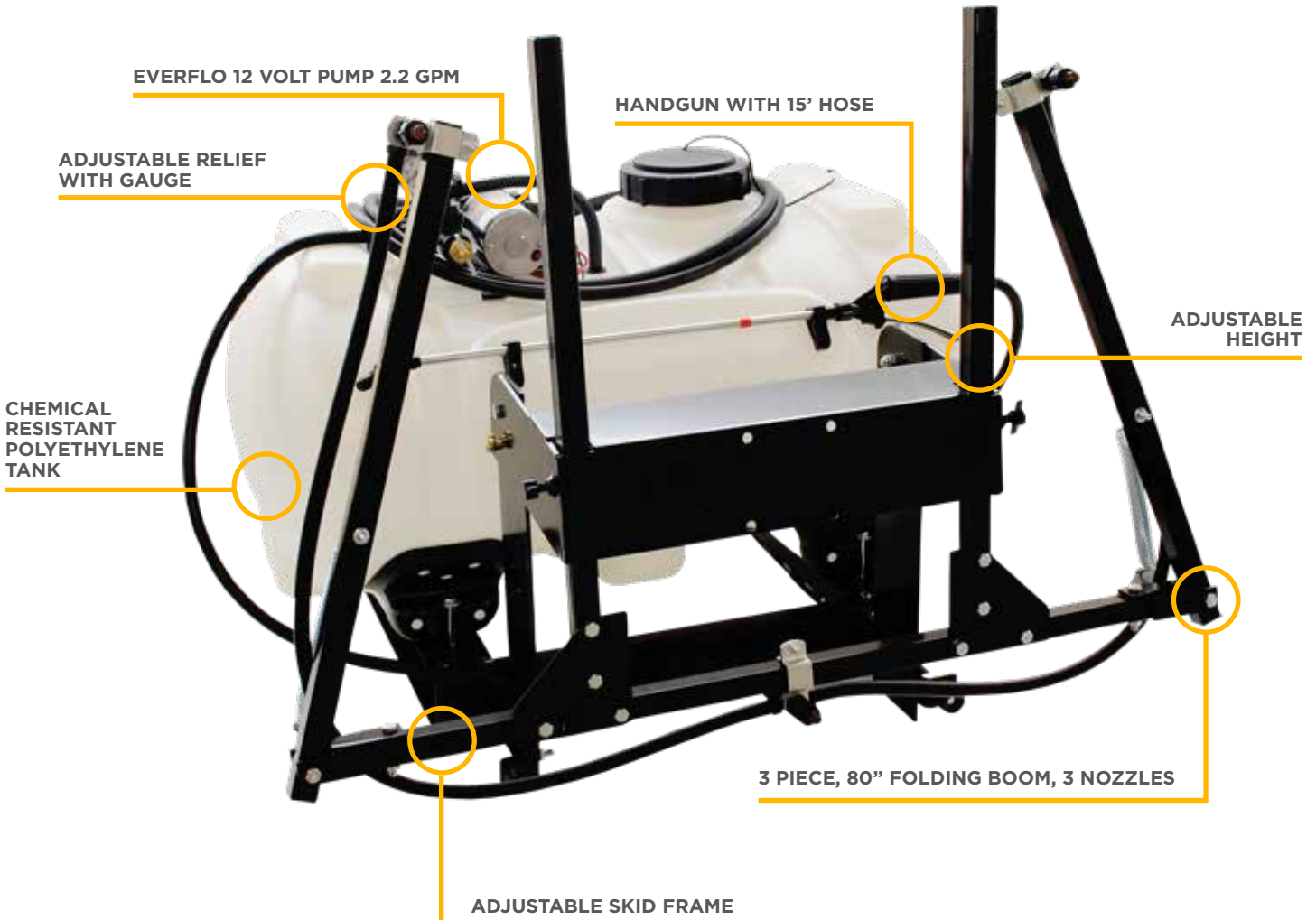

PART #	BE-RTVMS40	BE-RTVMS60
CAPACITY	40 GALLON	60 GALLON
PUMP	EVERFLO 12V	EVERFLO 12V

REPLACEMENT WEAR PARTS

PUMP	90.240.220	90.240.220
------	------------	------------

- 2.2 GPM / 8.3 LPM, 70 PSI / 4.5 Bars
- Fits most RTV boxes
- Includes remote switch
- Rubber bumpers ensure a snug fit over the RTV tailgate to minimize sliding in box



**40 & 60 GALLON
SKID MOUNT SPRAYERS**



PART #	BE-SMSE40-10	BE-SMSE60-10
CAPACITY	40 GALLON	60 GALLON
PUMP	1.8 GPM 12V	2.0 GPM 12V

REPLACEMENT WEAR PARTS

PUMP	90.543.936	90.240.220
------	------------	------------

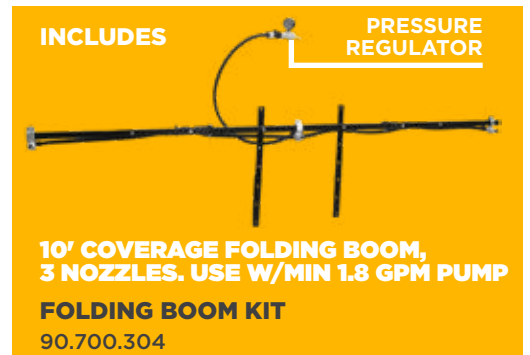

**PORTABLE SPOT SPRAYER
WITH HONDA ENGINE / AR30 PUMP & HOSE REEL
400 LITERS/ 105 GALLONS
90.830.400****PUMP FEATURES**

- AR30 pump: Max PSI: 580, Max GPM: 9.3
- Honda GX200 - 6.5 hp engine
- Tank agitator

HOSE REEL FEATURES

- 150' of 3/8" hose (Max PSI: 700)
- 150' hose reel rated for 5000 PSI
- A-frame design
- Stainless steel fittings

TANK FEATURES

- Pallet fork inserts
- Water fill screen
- Tie-down inserts
- Additional bolt mounts for other accessories

**PALLET FORK INSERTS****HOSE REEL****PORTABLE SPOT SPRAYER
WITH 12V PUMP & HOSE REEL
90.870.400****SPRAYER FEATURES**

- 90.787.101Y 12V Pump
- Max 100 PSI @ 2.55 GPM
- Max 7 GPM @ 10 PSI
- Tank agitator

TANK FEATURES

- Pallet fork inserts
- Water fill screen
- Tie-down inserts
- Additional bolt mounts for other accessories

**PALLET FORK INSERTS****12V DC CLAMPS******ACTUAL PRODUCT MAY NOT
BE EXACTLY AS PICTURED******PORTABLE FIRE SUPPRESSION TANK
90.895.400****SPRAYER FEATURES**

- 196 cc Honda GX200
- Recoil start and low oil shutdown
- 78 GPM Max flow
- 110 PSI Max
- 120' Total lift, 26' suction lift
- 1 X 1-1/2" MNPSH inlet/outlet
- 2 X 1" outlet
- Spark arrestor

TANK FEATURES

- Pallet fork inserts
- Water fill screen
- Tie-down inserts
- Additional bolt mounts for other accessories

****ACTUAL PRODUCT MAY NOT BE EXACTLY AS PICTURED**
PLEASE SEE WEBSITE FOR MORE INFORMATION



BlueFlex

MODEL # AR70



LOW PRESSURE EPOXY COATED 2 DIAPHRAGM PUMPS

PART #	90.100.070	90.102.070
DESCRIPTION	1-3/8" 6 SPLINE INPUT NO-THRU	35 MM ROUND BORE INPUT NO-THRU
WEIGHT	26 LBS	26 LBS
MAXIMUM FLOW	19.6 GPM / 74.1 LPM	19.6 GPM / 74.1 LPM
MAXIMUM PRESSURE	290 PSI / 20 BAR	290 PSI / 20 BAR
MAXIMUM RATED SPEED	550 RPM	550 RPM
MAXIMUM FLUID TEMP	140°F / 60°C	140°F / 60°C



BlueFlex

MODEL # AR160



LOW PRESSURE EPOXY COATED 4 DIAPHRAGM PUMP

PART #	90.100.160
DESCRIPTION	1-3/8" 6SP X 1-3/8 6 SP THRU SHAFT
WEIGHT	66 LBS
MAXIMUM FLOW	42.5 GPM / 160.9 LPM
MAXIMUM PRESSURE	290 PSI / 20 BAR
MAXIMUM RATED SPEED	550 RPM
MAXIMUM FLUID TEMP	140°F / 60°C



BlueFlex

MODEL # AR115



LOW PRESSURE EPOXY COATED 3 DIAPHRAGM PUMPS

PART #	90.100.115	90.102.115
DESCRIPTION	1-3/8" 6 SPLINE INPUT NO-THRU	35 MM ROUND BORE INPUT NO-THRU
WEIGHT	34.2 LBS	34.2 LBS
MAXIMUM FLOW	28.5 GPM / 107.9 LPM	28.5 GPM / 107.9 LPM
MAXIMUM PRESSURE	290 PSI / 20 BAR	290 PSI / 20 BAR
MAXIMUM RATED SPEED	550 RPM	550 RPM
MAXIMUM FLUID TEMP	140°F / 60°C	140°F / 60°C



BlueFlex

MODEL # AR30



MEDIUM PRESSURE EPOXY COATED 2 DIAPHRAGM PUMPS

PART #	90.100.030	90.101.030	90.103.030
DESCRIPTION	3 BOLT INPUT FLANGE NO THRU SHAFT	3 BOLT INPUT FLANGE 3/4" KEYED THRU SHAFT	3 BOLT INPUT FLANGE 1-3/8" 6 SPLINE THRU SHAFT
WEIGHT	20.5 LBS	20.5 LBS	20.5 LBS
MAXIMUM FLOW	9.6 GPM / 36.2 LPM	9.6 GPM / 36.2 LPM	9.6 GPM / 36.2 LPM
MAXIMUM PRESSURE	580 PSI / 40 BAR	580 PSI / 40 BAR	580 PSI / 40 BAR
MAXIMUM RATED SPEED	550 RPM	550 RPM	550 RPM
MAXIMUM FLUID TEMP	140°F / 60°C	140°F / 60°C	140°F / 60°C



BlueFlex
MODEL # AR50



MEDIUM PRESSURE EPOXY COATED 2 DIAPHRAGM PUMPS

PART #	90.100.050	90.101.050	90.103.050
DESCRIPTION	3 BOLT INPUT FLANGE NO THRU SHAFT	3 BOLT INPUT FLANGE 1" KEYED THRU SHAFT	3 BOLT INPUT FLANGE 1-3/8" 6 SPLINE THRU SHAFT
WEIGHT	39.3 LBS	39.3 LBS	39.3 LBS
MAXIMUM FLOW	17.4 GPM / 65.8 LPM	17.4 GPM / 65.8 LPM	17.4 GPM / 65.8 LPM
MAXIMUM PRESSURE	580 PSI / 40 BAR	580 PSI / 40 BAR	580 PSI / 40 BAR
MAXIMUM RATED SPEED	550 RPM	550 RPM	550 RPM
MAXIMUM FLUID TEMP	140°F / 60°C	140°F / 60°C	140°F / 60°C



BlueFlex
MODEL # AR813



HIGH PRESSURE ANODIZED ALUMINUM 3 DIAPHRAGM PUMP

PART #	90.100.813
DESCRIPTION	3 BOLT INPUT FLANGE 1-3/8" 6 SPLINE THRU SHAFT
WEIGHT	46 LBS
MAXIMUM FLOW	21.1 GPM / 79.9 LPM
MAXIMUM PRESSURE	725 PSI / 50 BAR
MAXIMUM RATED SPEED	550 RPM
MAXIMUM FLUID TEMP	140°F / 60°C



BlueFlex
MODEL # AR503



MEDIUM PRESSURE ANODIZED ALUMINUM 3 DIAPHRAGM PUMPS

PART #	90.100.503	90.101.503
DESCRIPTION	3 BOLT INPUT FLANGE NO THRU SHAFT	3 BOLT INPUT FLANGE 1-3/8" 6 SPLINE THRU SHAFT
WEIGHT	26 LBS	26 LBS
MAXIMUM FLOW	14.3 GPM / 54.1 LPM	14.3 GPM / 54.1 LPM
MAXIMUM PRESSURE	580 PSI / 40 BAR	580 PSI / 40 BAR
MAXIMUM RATED SPEED	550 RPM	550 RPM
MAXIMUM FLUID TEMP	140°F / 60°C	140°F / 60°C



BlueFlex
MODEL # AR1064



HIGH PRESSURE ANODIZED ALUMINUM 4 DIAPHRAGM PUMPS

PART #	90.101.064	90.102.064
DESCRIPTION	1-3/8" 6 SPLINE THRU SHAFT	3 BOLT INPUT FLANGE 1-3/8" 6 SPLINE THRU SHAFT
WEIGHT	52 LBS	52 LBS
MAXIMUM FLOW	28.7 GPM / 108.6 LPM	28.7 GPM / 108.6 LPM
MAXIMUM PRESSURE	725 PSI / 50 BAR	725 PSI / 50 BAR
MAXIMUM RATED SPEED	550 RPM	550 RPM
MAXIMUM FLUID TEMP	140°F / 60°C	140°F / 60°C

DIAPHRAGM PUMPS & ACCESSORIES



BlueFlex

MODEL # AR1203



HIGH PRESSURE ANODIZED ALUMINUM 3 DIAPHRAGM PUMPS

PART #	90.101.203	90.102.203
DESCRIPTION	3 BOLT INPUT FLANGE 1-3/8" 6 SPLINE THRU SHAFT	1-3/8" 6 SPLINE THRU SHAFT
WEIGHT	69 LBS	69 LBS
MAXIMUM FLOW	30.6 GPM / 115.83 LPM	30.6 GPM / 115.83 LPM
MAXIMUM PRESSURE	725 PSI / 50 BAR	725 PSI / 50 BAR
MAXIMUM RATED SPEED	550 RPM	550 RPM
MAXIMUM FLUID TEMP	140°F / 60°C	140°F / 60°C

**SPRAYER ASSEMBLY
7 HP POWEREASE ENGINE & COMET APS 41 PUMP
90.800.016**



* REGULATOR NOT INCLUDED.
* LIMITED STOCK

**SPRAYER ASSEMBLY
6.5 HP GX200 HONDA ENGINE & AR 30 PUMP
90.800.005**



**REMOTE MOUNT KIT
FOR GI40 CONTROL
90.200.041**



MEDIUM/HIGH PRESSURE DIAPHRAGM PUMP CONTROL UNIT

PART#	DESCRIPTION
90.200.900	CONTROL VALVE, AR GI40

- Control unit with working pressure regulating valve and glycerine bath pressure gauge with colored dial
- Compatible Pumps: AR30, AR50, AR303, AR403, AR503, AR713, AR813
- Max Flow: 21.1 GPM
- Max Pressure: 580 PSI

MODEL NO. GI40



HIGH PRESSURE DIAPHRAGM PUMP CONTROL UNIT

PART#	DESCRIPTION
90.200.050	CONTROL, AR VDR50

- Control unit with working pressure regulating valve, by-pass opening/closing lever and glycerine bath pressure gauge with colored dial
- Compatible Pumps: AR503, AR713, AR813, AR903, AR1053, AR1064, AR1203, BHA, BHS, BHP
- Max Flow: 34.3 GPM
- Max Pressure: 725 PSI

MODEL NO. VDR50



LOW PRESSURE DIAPHRAGM PUMP CONTROL UNIT

PART#	DESCRIPTION
90.200.005	CONTROL, VDR 20S

- Remote control unit with working pressure regulating valve, bar feeding opening/closure lever and glycerine bath pressure gauge with colored dial
- Compatible Pumps: AR70BP, AR115BP, AR125BP, AR135BP
- Max Flow: 34.3 GPM
- Max Pressure: 290 PSI

MODEL NO. VDR20S



LOW PRESSURE DIAPHRAGM PUMP CONTROL UNIT

PART#	DESCRIPTION
90.200.887	CONTROL, GS20S

- Remote control unit with working pressure regulating valve and glycerine bath pressure gauge with colored dial
- Compatible Pumps: AR70BP
- Max Flow: 13.2 GPM
- Max Pressure: 290 PSI

MODEL NO. GS20S



FITTINGS & SWIVELS

ORIFICES
HARDENED STEEL & ANODIZED COATING
 90.410.002



ORIFICES

PART#	DESCRIPTION
90.410.002	BE HARDENED D2 ORIFICE
90.410.003	BE HARDENED D3 ORIFICE
90.410.004	BE HARDENED D4 ORIFICE
90.410.005	BE HARDENED D5 ORIFICE
90.410.006	BE HARDENED D6 ORIFICE
90.410.007	BE HARDENED D7 ORIFICE
90.410.008	BE HARDENED D8 ORIFICE
90.410.010	BE HARDENED D10 ORIFICE

BRASS CORES/SWIVELS
BRASS SWIRL, NO # 25
 90.409.025



ORIFICES

PART#	DESCRIPTION
90.409.025	BRASS SWIRL, NO # 25
90.409.045	BRASS SWIRL, NO # 45

ROLLOVER NOZZLE
 73.617.39



BRASS SPRAY FITTINGS
BRASS NOZZLE BODY SWIVEL
1/4" FEMALE
 90.900.003



BRASS SPRAY FITTINGS
BRASS NOZZLE BODY SWIVEL
1/4" MALE
 90.900.049



BRASS SPRAY FITTINGS
BRASS NOZZLE BODY
DOUBLE SWIVEL 1/4" FEMALE
 90.900.004



BRASS SPRAY FITTINGS
BRASS NOZZLE BODY
DOUBLE SWIVEL 1/4" MALE
 90.900.050



BRASS SPRAY FITTINGS
BRASS NOZZLE BODY TEE
1/2" BARB
 90.900.053



3/8" BARB
 90.902.038

BRASS SPRAY FITTINGS
BRASS NOZZLE BODY ELBOW
1/2" BARB
 90.900.052



3/8" BARB
 90.901.038

BRASS SPRAY FITTINGS
BRASS NOZZLE BODY
1/4" MNPT X 11/16" M NOZZLE
 90.900.001



BRASS SPRAY FITTINGS
BRASS NOZZLE BODY
1/4" FNPT X 11/16" M NOZZLE
 90.900.031



BRASS NOZZLE CAP
 90.900.002



BRASS NOZZLE CAP
 90.900.006



110° & 80° ISO POLYACETAL FAN NOZZLES

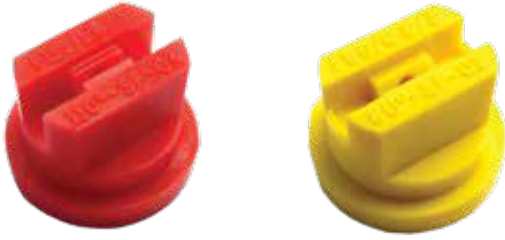

- Precision molded in polyacetal
- Narrow elliptical spray pattern
- 10 times the wear ability of brass
- Available in two spray angles of 80° and 110°
- Color coded for quick identification of flow rate
- Polyacetal has up to 10 times the wearability of standard brass tips!
- When boom mounted at 20" spacing, provide 50% overlap to give an overall even distribution

NOZZLE SPACING

SPRAY ANGLE	SUGGESTED SPRAY HEIGHTS	
	20" SPACING	30" SPACING
80°	24 - 26"	NOT SUITABLE
110°	14 - 16"	20 - 22"

APPLICATIONS

- Used for broadcast application of pre and post emergent herbicides, fungicides and insecticides.

PART #	SPRAY TIP	SPRAY ANGLE	PSI	GPM	FLOW (OZ/MIN)	GALLONS PER ACRE 20° SPACING								GALLONS PER ACRE 30° SPACING							
						5 MPH	6 MPH	7 MPH	8 MPH	10 MPH	12 MPH	14 MPH	16 MPH	5 MPH	6 MPH	7 MPH	8 MPH	10 MPH	12 MPH	14 MPH	16 MPH
ORANGE 90.110.001 90.080.001	#1	110°	30	0.09	11	5.2	4.3	3.7	3.3	2.6	2.2	1.8	1.6	3.5	2.9	2.5	2.2	1.7	1.4	1.2	1.1
			40	0.10	13	6.0	5.0	4.3	3.8	3.0	2.5	2.1	1.9	4.0	3.3	2.9	2.5	2.0	1.7	1.4	1.3
	#1	80°	45	0.11	14	6.5	5.3	4.6	4.0	3.2	2.7	2.3	2.0	4.3	3.5	3.0	2.7	2.1	1.8	1.5	1.3
			50	0.11	15	6.7	5.6	4.8	4.2	3.4	2.8	2.4	2.1	4.5	3.7	3.2	2.8	2.2	1.9	1.6	1.4
GREEN 90.110.015 90.080.015	#1.5	110°	30	0.13	16	7.8	7.0	5.6	4.9	3.9	3.2	2.8	2.4	5.2	4.3	3.7	3.2	2.6	2.2	1.8	1.6
			40	0.15	19	9.0	7.5	6.4	5.6	4.5	3.7	3.2	2.8	6.0	5.0	4.3	3.7	3.0	2.5	2.1	1.9
	#1.5	80°	45	0.16	21	9.6	8.0	6.8	6.0	4.8	4.0	3.4	3.0	6.4	5.3	4.5	4.0	3.2	2.6	2.0	2.0
			50	0.17	22	10.1	8.4	7.2	6.3	5.0	4.2	3.6	3.1	6.7	5.6	4.8	4.2	3.4	2.8	2.4	2.1
YELLOW 90.110.002 90.080.002	#2	110°	30	0.18	22	10.4	8.7	7.4	6.5	5.2	4.3	3.7	3.3	7.0	5.8	5.0	4.3	3.5	2.9	2.5	2.2
			40	0.20	26	12.0	10.0	8.6	7.5	6.0	5.0	4.3	3.8	8.0	6.7	5.7	5.0	4.0	3.3	2.9	2.5
	#2	80°	45	0.21	28	12.8	10.6	9.1	8.0	6.4	5.3	4.6	4.0	8.5	7.1	6.1	5.3	4.3	3.5	3.0	2.7
			50	0.23	29	13.5	11.2	9.6	8.4	6.7	5.6	4.8	4.2	9.0	7.5	6.4	5.6	4.5	3.7	3.2	2.8
BLUE 90.110.003 90.080.003	#3	110°	30	0.26	34	15.6	13.0	11.2	9.8	7.8	6.5	5.6	4.9	10.4	8.7	7.4	6.5	5.2	4.3	3.7	3.3
			40	0.30	39	18.1	15.0	12.9	11.3	9.0	7.5	6.4	5.6	12.0	10.0	8.6	7.5	6.0	5.0	4.3	3.8
	#3	80°	45	0.32	41	19.2	16.0	13.7	12.0	9.6	8.0	6.8	6.0	12.8	10.6	9.1	8.0	6.4	5.3	4.6	4.0
			50	0.34	44	20.2	16.8	14.4	12.6	10.1	8.4	7.2	6.3	13.5	11.2	9.6	8.4	6.7	5.6	4.8	4.2
RED 90.110.004 90.080.004	#4	110°	30	0.35	45	20.9	17.4	14.9	13.0	10.4	8.7	7.4	6.5	13.9	11.6	9.9	8.7	7.0	5.8	5.0	4.3
			40	0.41	52	24.1	20.1	17.2	15.0	12.0	10.0	8.6	7.5	16.1	13.4	11.5	10.0	8.0	6.7	5.7	5.0
	#4	80°	45	0.43	55	25.5	21.3	18.2	16.0	12.8	10.6	9.1	8.0	17.0	14.2	12.2	10.6	8.5	7.1	6.1	5.3
			50	0.45	58	26.9	22.4	19.2	16.8	13.5	11.2	9.5	8.4	17.9	15.0	12.8	11.2	9.0	7.5	6.4	5.6
BROWN 90.110.005 90.080.005	#5	110°	30	0.44	56	26.1	21.7	18.6	16.3	13.0	10.9	9.3	8.1	17.4	14.5	12.4	10.9	8.7	7.2	6.2	5.4
			40	0.51	65	30.1	25.1	21.5	18.8	15.0	12.5	10.7	9.4	20.1	16.7	14.3	12.5	10.0	8.4	7.2	6.3
	#5	80°	45	0.54	69	31.9	26.6	22.8	20.0	16.0	13.3	11.4	10.0	21.3	17.7	15.2	13.3	10.6	8.9	7.6	6.7
			50	0.57	73	33.7	28.0	24.0	21.0	16.8	14.0	12.0	10.5	22.4	18.7	16.0	14.0	11.2	9.3	8.0	7.0
GRAY 90.110.006 90.080.006	#6	110°	30	0.53	67	31.3	26.1	22.3	19.5	15.6	13.0	11.2	9.8	20.9	17.4	14.9	13.0	10.4	8.7	7.4	6.5
			40	0.61	78	36.1	30.1	25.8	22.6	18.1	15.0	12.9	11.3	24.1	20.1	17.2	15.0	12.0	10.0	8.6	7.5
	#6	80°	45	0.64	83	38.3	31.9	27.4	23.9	19.2	16.0	13.7	12.0	25.5	21.3	18.2	16.0	12.8	10.6	9.1	8.0
			50	0.68	87	40.4	33.7	28.8	25.2	20.2	16.8	14.4	12.6	26.9	22.4	19.2	16.8	13.5	11.2	9.6	8.4
WHITE 90.110.008 90.080.008	#8	110°	30	0.70	90	41.7	34.8	29.8	26.1	20.9	17.4	14.9	13.0	27.8	23.2	19.9	17.4	13.9	11.6	9.9	8.7
			40	0.81	104	48.2	40.1	34.4	30.1	24.1	20.1	17.2	15.0	32.1	26.8	22.9	20.1	16.1	13.4	11.5	10.0
	#8	80°	45	0.86	110	51.1	42.6	36.5	31.9	25.5	21.3	18.2	16.0	34.1	28.4	24.3	21.3	17.0	14.2	12.2	10.6
			50	0.91	116	53.8	44.9	38.5	33.7	26.9	22.4	19.2	16.8	35.9	29.9	25.6	22.4	17.9	15.0	12.8	11.2
LIGHT BLUE 90.110.010 90.080.010	#10	110°	30	0.88	112	52.1	43.4	37.2	32.6	26.1	21.7	18.6	16.3	34.8	29.0	24.8	21.7	17.4	14.5	12.4	10.9
			40	1.01	130	60.2	50.2	43.0	37.6	30.1	25.1	21.5	18.8	40.1	33.4	28.7	25.1	20.1	16.7	14.3	12.5
	#10	80°	45	1.07	138	63.8	53.2	45.6	39.9	31.9	26.6	22.8	20.0	42.6	35.5	30.4	26.6	21.3	17.7	15.2	13.3
			50	1.13	145	67.3	56.1	48.1	42.1	33.7	28.0	24.0	21.0	44.9	37.4	32.0	28.0	22.4	18.7	16.0	14.0
60	1.24	159	73.7	61.4	52.7	46.1	36.9	30.7	26.3	23.0	49.1	41.0	35.1	30.7	24.6	20.5	17.6	15.4			

110° ISO FAN NOZZLES, CERAMIC INSERT



- Available in 110° spray angle
- Precision molded in polyacetal
- Color coded for quick identification of flow rate
- Ceramic tip lasts 90-100 times longer than a standard brass tip

NOZZLE SPACING

SPRAY ANGLE	SUGGESTED SPRAY HEIGHTS	
	20" SPACING	30" SPACING
110°	14 - 16"	20 - 22"

APPLICATIONS

- Used for broadcast application of pre and post emergent herbicides, fungicides and insecticides.

PART #	SPRAY TIP	SPRAY ANGLE	PSI	GPM	FLOW (OZ/MIN)	GALLONS PER ACRE 20° SPACING								GALLONS PER ACRE 30° SPACING							
						5 MPH	6 MPH	7 MPH	8 MPH	10 MPH	12 MPH	14 MPH	16 MPH	5 MPH	6 MPH	7 MPH	8 MPH	10 MPH	12 MPH	14 MPH	16 MPH
GREEN 93.110.015	#1.5	110°	30	0.13	17	7.8	6.5	5.6	4.9	3.9	3.3	2.8	2.4	5.2	4.3	3.7	3.3	2.6	2.2	1.9	1.6
			40	0.15	19	9.0	7.5	6.4	5.6	4.5	3.8	3.2	2.8	6.0	5.0	4.3	3.8	3.0	2.5	2.1	1.9
			45	0.16	21	9.6	8.0	6.8	6.0	4.8	4.0	3.4	3.0	6.4	5.3	4.6	4.0	3.2	2.7	2.3	2.0
			50	0.17	22	10.1	8.4	7.2	6.3	5.0	4.2	3.6	3.2	6.7	5.6	4.8	4.2	3.4	2.8	2.4	2.1
			60	0.19	24	11.1	9.2	7.9	6.9	5.5	4.6	3.9	3.5	7.4	6.1	5.3	4.6	3.7	3.1	2.6	2.3
YELLOW 93.110.002	#2	110°	30	0.18	22	10.4	8.7	7.4	6.5	5.2	4.3	3.7	3.3	7.0	5.8	5.0	4.3	3.5	2.9	2.5	2.2
			40	0.20	26	12.0	10.0	8.6	7.5	6.0	5.0	4.3	3.8	8.0	6.7	5.7	5.0	4.0	3.3	2.9	2.5
			45	0.21	28	12.8	10.6	9.1	8.0	6.4	5.3	4.6	4.0	8.5	7.1	6.1	5.3	4.3	3.5	3.0	2.7
			50	0.23	29	13.5	11.2	9.6	8.4	6.7	5.6	4.8	4.2	9.0	7.5	6.4	5.6	4.5	3.7	3.2	2.8
			60	0.25	32	14.7	12.3	10.5	9.2	7.4	6.1	5.3	4.6	9.8	8.2	7.0	6.1	4.9	4.1	3.5	3.1
BLUE 93.110.003	#3	110°	30	0.26	34	15.6	13.0	11.2	9.8	7.8	6.5	5.6	4.9	10.4	8.7	7.4	6.5	5.2	4.3	3.7	3.3
			40	0.30	39	18.1	15.0	12.9	11.3	9.0	7.5	6.4	5.6	12.0	10.0	8.6	7.5	6.0	5.0	4.3	3.8
			45	0.32	41	19.2	16.0	13.7	12.0	9.6	8.0	6.8	6.0	12.8	10.6	9.1	8.0	6.4	5.3	4.6	4.0
			50	0.34	44	20.2	16.8	14.4	12.6	10.1	8.4	7.2	6.3	13.5	11.2	9.6	8.4	6.7	5.6	4.8	4.2
			60	0.37	48	22.1	18.4	15.8	13.8	11.1	9.2	7.9	6.9	14.7	12.3	10.5	9.2	7.4	6.1	5.3	4.6
RED 93.110.004	#4	110°	30	0.35	45	20.9	17.4	14.9	13.0	10.4	8.7	7.4	6.5	13.9	11.6	9.9	8.7	7.0	5.8	5.0	4.3
			40	0.41	52	24.1	20.1	17.2	15.0	12.0	10.0	8.6	7.5	16.1	13.4	11.5	10.0	8.0	6.7	5.7	5.0
			45	0.43	55	25.5	21.3	18.2	16.0	12.8	10.6	9.1	8.0	17.0	14.2	12.2	10.6	8.5	7.1	6.1	5.3
			50	0.45	58	26.9	22.4	19.2	16.8	13.5	11.2	9.5	8.4	17.9	15.0	12.8	11.2	9.0	7.5	6.4	5.6
			60	0.50	64	29.5	24.6	21.1	18.4	14.7	12.3	10.5	9.2	19.7	16.4	14.0	12.3	9.8	8.2	7.0	6.1
BROWN 93.110.005	#1	110°	30	0.44	56	26.1	21.7	18.6	16.3	13.0	10.9	9.3	8.1	17.4	14.5	12.4	10.9	8.7	7.2	6.2	5.4
			40	0.51	65	30.1	25.1	21.5	18.8	15.0	12.5	10.7	9.4	20.1	16.7	14.3	12.5	10.0	8.4	7.2	6.3
			45	0.54	69	31.9	26.6	22.8	20.0	16.0	13.3	11.4	10.0	21.3	17.7	15.2	13.3	10.6	8.9	7.6	6.7
			50	0.57	73	33.7	28.0	24.0	21.0	16.8	14.0	12.0	10.5	22.4	18.7	16.0	14.0	11.2	9.3	8.0	7.0
			60	0.62	79	36.9	30.7	26.3	23.0	18.4	15.4	13.2	11.5	24.6	20.5	17.6	15.4	12.3	10.2	8.8	7.7
GRAY 93.110.006	#1	110°	30	0.53	67	31.3	26.1	22.3	19.5	15.6	13.0	11.2	9.8	20.9	17.4	14.9	13.0	10.4	8.7	7.4	6.5
			40	0.61	78	36.1	30.1	25.8	22.6	18.1	15.0	12.9	11.3	24.1	20.1	17.2	15.0	12.0	10.0	8.6	7.5
			45	0.64	83	38.3	31.9	27.4	23.9	19.2	16.0	13.7	12.0	25.5	21.3	18.2	16.0	12.8	10.6	9.1	8.0
			50	0.68	87	40.4	33.7	28.8	25.2	20.2	16.8	14.4	12.6	26.9	22.4	19.2	16.8	13.5	11.2	9.6	8.4
			60	0.74	95	44.2	36.9	31.6	27.6	22.1	18.4	15.8	13.8	29.5	24.6	21.1	18.4	14.7	12.3	10.5	9.2

140° DEFLECTOR NOZZLES

- 14 To 43 PSI
- Wide spray angle of 140°
- Produces coarse droplets
- Fits standard nozzle caps
- Narrow rectangular spray pattern
- Molded in high performance color coded polyacetal
- Screwdriver slot at front to align nozzle in standard caps
- APPLICATIONS
- This nozzle is well suited to broadcast spraying with small boom sprayers fitted to all-terrain vehicles. The wide angle allows the nozzles to be spaced at 40" intervals
- Effectively reducing the number of nozzles required.



POLYACETAL HAS UP TO 10 TIMES THE WEARABILITY OF STANDARD BRASS TIPS!

PART #	SPRAY TIP#	SPRAY ANGLE	PSI	GPM	FLOW (OZ/MIN)	GALLONS PER ACRE 40° SPACING						
						3 MPH	4 MPH	5 MPH	6 MPH	7 MPH	8 MPH	9 MPH
RED 90.140.002	#2	140°	15	0.25	31	12.1	9.1	7.3	6.1	5.2	4.5	4.0
			20	0.28	36	14.0	10.5	8.4	7.0	6.0	5.3	4.7
			25	0.32	40	15.7	11.7	9.4	7.8	6.7	5.9	5.2
			30	0.35	44	17.2	12.9	10.3	8.6	7.4	6.4	5.7
			35	0.37	48	18.5	13.9	11.1	9.3	7.9	6.9	6.2
BROWN 90.140.025	#2.5	140°	15	0.31	39	15.2	11.4	9.1	7.6	6.5	5.7	5.1
			20	0.35	45	17.5	13.1	10.5	8.7	7.5	6.6	5.8
			25	0.40	51	19.6	14.7	11.7	9.8	8.4	7.3	6.5
			30	0.43	55	21.4	16.1	12.9	10.7	9.2	8.0	7.1
			35	0.47	60	23.1	17.4	13.9	11.6	9.9	8.7	7.7
GREY 90.140.003	#3	140°	15	0.37	47	18.2	13.6	10.9	9.1	7.8	6.8	6.1
			20	0.42	54	21.0	15.7	12.6	10.5	9.0	7.9	7.0
			25	0.47	61	23.5	17.6	14.1	11.7	10.1	8.8	7.8
			30	0.52	66	25.7	19.3	15.4	12.9	11.0	9.6	8.6
			35	0.56	72	27.8	20.8	16.7	13.9	11.9	10.4	9.3

HOLLOW CONE CERAMIC NOZZLE

- Available in 80° spray angle
- Complete with swirl assembly
- Precision molded in polyacetal
- Color coded for quick identification of flow rate
- Ceramic tip lasts 90-100 times longer than standard brass tip



CERAMIC HAS UP TO 100 TIMES THE WEARABILITY OF STANDARD BRASS TIPS!

PART #	SPRAY TIP #	SPRAY ANGLE	GALLONS PER MINUTE					
			44 PSI	58 PSI	73 PSI	101 PSI	145 PSI	218 PSI
RED 93.100.001	#1	80°	0.10	0.12	0.13	0.15	0.18	0.22
ORANGE 93.100.002	#2	80°	0.21	0.24	0.27	0.31	0.37	0.46
GRAY 93.100.003	#3	80°	0.31	0.36	0.40	0.46	0.55	0.66
BLACK 93.100.004	#4	80°	0.41	0.47	0.53	0.62	0.73	0.89
BLUE 93.100.005	#5	80°	0.53	0.58	0.63	0.74	0.89	1.07

ISO STANDARD BAYONET CAPS

PART #	SIZE	COLOR
90.900.170	ISO STANDARD	BLACK
90.900.171	ISO STANDARD	BLUE
90.900.172	ISO STANDARD	RED
90.900.173	ISO STANDARD	YELLOW
90.900.174	ISO STANDARD	GREEN
90.900.175	ISO STANDARD	BROWN

ISO STANDARD BAYONET CAPS 90.900.171



- Complete with gaskets
- Precision molded Polyacetal
- ISO color coded for easy identification

HARDI HOLLOW CONE CONVERSION CAP 90.900.162



- Complete with gaskets
- Precision molded Polyacetal
- Converts from Hardi systems to ISO standard fan tips

SNAP-FIT NOZZLE HOLDER 334083



SPRAY WANDS & ACCESSORIES

**18" LANCE
SPOT SPRAYER**
450 MM
90.300.005

**24" LANCE
SPOT SPRAYER**
600 MM
90.300.105

**30" LANCE
SPOT SPRAYER**
450 MM
90.300.205



SIMPLY REMOVE THE NOZZLE AND ATTACH
THE SPRAY SHIELD DIRECTLY TO AN
18", 24", OR 30" SPRAY GUN!

SPRAY SHIELD
PART# 90.900.087



**13" SPRAYER GUN
WITH ALUMINUM BARREL**
90.300.008M



**22" SPRAYER GUN
WITH ALUMINUM BARREL**
90.300.008



**23" SPRAYER GUN
WITH ALUMINUM BARREL**
90.100.502



600 MM LOW PRESSURE GUN
U45050000



1500 MM LOW PRESSURE TELESCOPING GUN
U45050005



700 PSI 12" WAND & GUN
90.300.001



700 PSI 24" WAND & GUN
90.300.002



16" LENGTH FLASH GUN
90.300.006



INCLUDES
3/8" BRASS
HOSE BARB

- High Quality
- Greenhouse Gun

26.5" LONG RANGE SPRAY GUN
90.300.007



INCLUDES
1/2" BRASS
HOSE BARB

150 PSI REGULATOR
1/2" MNPT, 3/4" FPT
POLYPRO
 90.922.026



POLYPRO CONSTRUCTION 3/4" FPT REGULATORS

PART#	PSI	INLET
90.922.026	150	1/2" MNPT
90.920.026	400	1/2" MNPT
90.920.057	150	3/4" MNPT
90.922.057	250	3/4" MNPT
90.924.057	400	3/4" MNPT

300 PSI REGULATOR
3/4" M, 3/4" FPT
ALUMINUM BYPASS W/
STAINLESS STEEL BALL
 90.910.026



300 PSI REGULATOR
3/4" M, 3/4" FPT
BRASS BYPASS W/
STAINLESS STEEL BALL
 90.900.026



ALUMINUM & BRASS 3/4" FPT REGULATORS

PART#	PSI	INLET
ALUMINUM REGULATOR		
90.910.026	300	3/4" MNPT
BRASS REGULATOR		
90.900.026	300	3/4" MNPT

HANDLE
BRASS, RUBBER HANDLE,
4754 TYPE GHT
 90.900.027



SPRAY SHIELD
HOOD COMES WITH
110-03 FAN NOZZLE
 90.900.087



WAND TANK CLIP (PAIR)
 U4505001



TEFLON TAPE,
12 PACK
 85.400.110



STANDARD 6" SPRAYER LID
 90.700.030



2" TANK TIE DOWN
ANCHOR BRACKET
 TD200B



POLYPRO BULKHEAD FITTINGS
1/2", POLY PRO,
1 3/4" OPENING
 90.910.012



POLYPRO BULKHEAD FITTINGS

PART#	DESCRIPTION
90.910.012	1/2", POLY PRO, 1-3/4" OPENING
90.910.034	3/4", POLY PRO, 1-3/4" OPENING
90.910.100	1", POLY PRO, 2-1/8" OPENING
90.910.114	1-1/4", POLY PRO, 2-5/8" OPENING
90.910.112	1-1/2", POLY PRO, 2-5/8" OPENING
90.910.200	2", POLY PRO, 3-1/4" OPENING
90.910.300	3", POLY PRO, 4-3/8" OPENING
90.910.400	4", POLY PRO, 4-3/8" OPENING

HOSE REELS



PART #	85.402.050	85.402.001	85.402.001K	85.402.002	85.402.014	85.402.010
HOSE SIZE	3/8"	3/8"	3/8"	3/8"	3/8"	3/8"
MAX CAPACITY	50'	100'	100'	200'	150'	50'
MAX PSI	4000	4000	4000	4000	5000	4000
MAX TEMP.	71°C / 160°F	71°C / 160°F	71°C / 160°F	71°C / 160°F	150°C / 302°F	71°C / 160°F
REPLACEMENT SWIVEL	85.402.004	85.402.005S	85.402.005S	85.402.005S	2103246	85.402.004
SWIVEL REPAIR KIT	85.402.009	85.402.009S	85.402.009S	85.402.009S	N/A	85.402.009
INLET SIZE	3/8"	3/8"	3/8"	3/8"	1/2"	3/8"
OUTLET SIZE	3/8"	3/8"	3/8"	3/8"	1/2"	3/8"
STACKING FRAME	N/A	N/A	N/A	N/A	85.402.151	N/A
HOSE GUIDE	N/A	N/A	N/A	N/A	2100462	N/A
DIMS (LXWXH)	13" X 11.75" X 11"	13" X 18" X 11"	17" X 18" X 13.5"	20" X 15.75" X 17.25"	15.25" X 22" X 18.6"	13" X 12" X 18"
WEIGHT (LBS)	12 LBS	15 LBS	17 LBS	21 LBS	30 LBS	28 LBS



PART #	85.402.003BAR	85.402.003F	85.401.020	85.401.040	85.410.020	85.410.040
HOSE SIZE	3/8"	3/8"	3/8"	3/8"	3/8"	3/8"
MAX CAPACITY	150'	150'	200'	400'	200'	400'
MAX PSI	5000	5000	3000	3000	3000	3000
MAX TEMP.	N/A	120°C / 250°F	N/A	N/A	N/A	N/A
REPLACEMENT SWIVEL	N/A	N/A	N/A	N/A	N/A	N/A
SWIVEL REPAIR KIT	N/A	N/A	N/A	N/A	N/A	N/A
INLET SIZE	1/2"	3/8"	3/8"	3/8"	3/8"	3/8"
OUTLET SIZE	1/2"	3/8"	3/8"	3/8"	3/8"	3/8"
STACKING FRAME	N/A	N/A	N/A	N/A	N/A	N/A
HOSE GUIDE	N/A	N/A	V	N/A	N/A	N/A
DIMS (LXWXH)	N/A	17.5" X 12.5" X 19.5"	19.5" X 14.75" X 19.5"	19.5" X 21" X 19.5"	19.5" X 14.75" X 19.5"	19.5" X 21" X 19.5"
WEIGHT (LBS)	N/A	24.9 LBS	16.75 LBS	18.8 LBS	16.75 LBS	18.8 LBS

12V & ROLLER PUMPS

PUMP, 4 ROLLER
4900C



- Max GPM: 9.2
- Max PSI: 150
- 5/8" Solid CW Rotation
- Cast Iron Series

DELAVAN

PUMP, 6 ROLLER
6900C



- Max GPM: 19.6
- Max PSI: 200
- CCW Rotation
- Cast Iron Series

DELAVAN

PUMP, 7 ROLLER
7900C



- Max GPM: 22.5
- Max PSI: 200
- CCW Rotation
- Cast Iron Series

DELAVAN

12V DEMAND PUMP
90.218.120



- Max GPM: 1.8
- Max PSI: 120
- Dual Motor
- Twin Fan

12V DEMAND PUMP
90.220.201



- Max GPM: 1.0
- Max PSI: 40
- 2 Chamber, 2 Pin
- 3/8" H.B.

DELAVAN

12V DEMAND PUMP
90.220.202



- Max GPM: 1.0
- Max PSI: 40
- 2 Chamber, 2 Pin
- 3/8" H.B.

DELAVAN

12V DEMAND PUMP
90.780.230



- Max GPM: 2.1
- Max PSI: 60
- 2 Pin Connector, 3/8" FNPT Ports
- Model 7812-301

DELAVAN

12V DEMAND PUMP
90.583.301



- Max GPM: 3.0
- Max PSI: 45
- 2 Pin Connector
- On/Off Switch, 1/2" FNPT Port
- Model 5830-301C

DELAVAN

12V DEMAND PUMP
90.585.101



- Max GPM: 5.0
- Max PSI: 45
- (Lead Wires)
- 1/2" FNPT Port
- Model 5850-101C

DELAVAN

12V DEMAND PUMP
90.787.101



- Max GPM: 7.0
- Max PSI: 60

DELAVAN

12V DEMAND PUMP
90.543.936



- Shurflo 12V
- Max GPM: 1.8
- Max PSI: 60

SHURFLO

EVERFLO 12 VOLT DEMAND PUMPS

**NON BOXED PRICES
INCLUDES DEMAND SWITCH & 2 PIN CONNECTOR
AVAILABLE BOXED!!**

ADD "B" TO END FOR RETAIL BOXED VERSIONS, DIFFERENT PRICING APPLIES TO BOXED VERSIONS

PUMP, 12V
90.240.100

BOXED ITEM
90.240.100B



- Max GPM: 1.0
- Max PSI: 40
- 2.8 Bar, 12V, 4.0 Amp, 3/8" HB
- Bulk

PUMP, 12V
90.240.220

BOXED ITEM
90.240.220B



- Max GPM: 2.2
- Max PSI: 70
- 4.5 Bar 12V, 7.5 Amps, 3/8" NPT
- Bulk

PUMP, 12V
90.240.300

BOXED ITEM
90.240.300B



- Max GPM: 3.0
- Max PSI: 60
- 4.1 Bar, 12V, 10.0 Amps, 1/2" NPT
- Bulk

PUMP, 12V
90.240.400

BOXED ITEM
90.240.400B



- Max GPM: 4.0
- Max PSI: 60
- 4.1 Bar, 4.0 GPM, 13 Amps, 1/2" NPT
- Bulk

PUMP, 12V
90.240.550

BOXED ITEM
90.240.550B



- Max GPM: 5.5
- Max PSI: 60
- 4.1 Bar, 12V, 17 Amps, 1/2" NPT
- Bulk

PEDESTAL AND DRUM FAN



PART #	FD24	FP30	FD36	FD42	FD42B	FD48B
SIZE	24"	30"	36"	42"	42"	48"
STYLE	BARREL/DRUM	PEDESTAL	BARREL/DRUM	BARREL/DRUM	BARREL/DRUM	BARREL/DRUM
DRIVE TYPE	DIRECT	DIRECT	DIRECT	DIRECT	BELT	BELT
CFM	7700	8750	11200	15400	17700	19500
SPEEDS	2	2	2	2	2	2
MOTOR SIZE	0.17 HP	0.2 HP	0.33 HP	0.5 HP	1 HP	1.5 HP
VOLTAGE	120	120	120	120	120	120
HZ	60	60	60	60	60	60
AMPS	1.9	1.8	8.8	5.5	6.5	9.0
BLADE MATERIAL	BALANCED STEEL	BALANCED STEEL	BALANCED STEEL	BALANCED STEEL	BALANCED STEEL	BALANCED STEEL
BLADES	3	3	3	4	4	4
TILTABLE (F)	180	75	N/A	N/A	N/A	N/A
WEIGHT (LBS)	35	64	65	84	101	108
QTY PER PALLET	12	12	6	6	6	6
DIMENSIONS	30" X 24" X 12"	44" X 34" X 8"	40" X 42" X 13"	45" X 46" X 15"	53" X 51" X 15"	53" X 51" X 51"
CERTIFICATIONS						
WARRANTY	6 MONTHS	6 MONTHS	6 MONTHS	6 MONTHS	1 YR	1 YR





**WATER IS A VITAL RESOURCE.
IT IS ESSENTIAL FOR GROWING CROPS AND SUSTAINING LIVESTOCK. HOWEVER, MOTHER NATURE CAN SEND TOO MUCH WATER THAT CAN FLOOD FIELDS AND BASEMENTS.
WATER PUMPS WILL ALLOW YOU TO MOVE THE WATER WHERE YOU WANT IT.**

TYPES OF TRANSFER PUMPS

All transfer pumps are very similar in design. The pump is mounted onto an engine that drives the system. Every pump has an impeller spinning in a whorl case inside the pump body. However, the specific materials used to build the pump will give it special abilities to handle different tasks.

WATER TRANSFER PUMP

These are general-purpose pumps that effectively move water. They are best used with clean water to prolong longevity.

HIGH PRESSURE PUMP

These pumps have greater pressure, but lower water volume output. This trade off allows them to push water greater distances than other pumps. With the proper attachments they can spray water and be used in emergency fire fighting situations.

CHEMICAL PUMP

These are easily identified by their black pump bodies, which are built with fiberglass-reinforced polyester. This unique construction allows them to move a variety of agriculture and industrial chemicals such as liquid fertilizer.

SEMI-TRASH PUMP

Built with reinforced aluminum pumps and heavy-duty seals for applications with dirty water. These pumps will handle dirt, grit and solids up 5/8" T-Handle bolts on the pump allow toolless access when it needs to be cleaned out.

FULL TRASH PUMPS

An extremely powerful and rugged design. The heavy-duty pump frame and cast iron impellers allow it to take solids up to 1-inch diameter. The pump has a flange system to allow easy access to open it up and clean out refuse.

SUBMERSIBLE PUMP

Comparatively small electric water pumps that are often referred to sub pumps. They are used to drain standing clean water.

KEY RATINGS TERMS

Suction Lift: the total vertical distance a water pump can lift water from the source bringing it into the pump housing.

Discharge Lift: the total vertical distance a water pump can push water out of the pump housing.

Total Lift: The combined vertical distance of the suction and discharge lift.

PSI (Pounds per Square Inch): refers to the force of the water coming out of the pump. The higher the rating, the further distance the water can be pumped.

GPM (Gallons per Minute): refers to the volume of water the pump can transfer.

CHOOSING A WATER PUMP

APPLICATION	SUBMERSIBLE PUMP	WATER TRANSFER PUMP	HIGH PRESSURE PUMP	NYLON CHEMICAL PUMP	SEMI-TRASH PUMP	TRASH PUMP
CLEAR WATER	X	X	X	X	X	X
SEPTIC TANK		X	X	X	X	X
SALT WATER			X	X	X	X
SLIMY WATER				X	X	X
MUCK WATER				X	X	X
MUD WATER				X	X	X
ABRASIVE WATER					X	X
SLOW SEEPAGE DITCH WATER					X	X
MAN HOLES					X	X
BRUSH FIRES			X			
LIQUID FERTILIZER				X		
HIGH SOLID CONTENT WATER						X

POWER EASE



PART #	WP-1020R	WP-1015HT	WP-2070S	WP2065K
SERIES	WORKSHOP SERIES	WORKSHOP SERIES	WORKSHOP SERIES	WORKSHOP SERIES
ENGINE TYPE	POWEREASE 79 CC	HONDA GX25	POWEREASE 225 CC	KOHLER SH270 196 CC
PORT SIZE - INLET/OUTLET	1"	1"	2"	2"
GPM	42	36	158	158
PSI	37	37	33	32
SUCTION LIFT	23'	26'	23'	26'
TOTAL LIFT	85'	100'	82'	82'
ENGINE OIL TYPE	SAE 10W 30	SAE 10W 30	SAE 10W 30	SAE 10W 30
LOW OIL SHUTDOWN	NO	NO	YES	NO
FUEL TANK CAPACITY	0.6 L (0.15 US GAL)	0.6 L (0.15 US GAL)	3.1 L (0.82 US GAL)	3.3 L (0.85 US GAL)
HOUSING	ALUMINUM	ALUMINUM	ALUMINUM	ALUMINUM
IMPELLER	ALUMINUM	ALUMINUM	CAST IRON	CAST IRON
FITTINGS	1" NPT	1" NPT	2" NPT	2" NPT
SHIPPING (LxWxH)	16" X 12" X 16"	16" X 12" X 16"	21" X 17" X 19"	21" X 17" X 19"
WEIGHT	42 LBS	32 LBS	60 LBS	55 LBS
KIT OPTION WITH SUCTION & DISCHARGE HOSE	N/A	N/A	WPK-2065CM	N/A
WARRANTY *FOR MANUFACTURE DEFECTS	2 YRS PUMP 2 YRS ENGINE	2 YRS PUMP 2 YRS ENGINE	2 YRS PUMP 2 YRS ENGINE	2 YRS PUMP 2 YRS ENGINE

POWERED by HONDA



PART #	WP-2065HL	WP-3070S	WP-3065HL	WP4013H
SERIES	WORKSHOP SERIES	WORKSHOP SERIES	COMMERCIAL SERIES	COMMERCIAL SERIES
ENGINE TYPE	HONDA GX200	POWEREASE 225 CC	HONDA GX200	HONDA GX390
PORT SIZE - INLET/OUTLET	2"	3"	3"	4"
GPM	158	264	264	422
PSI	33	35	35	38
SUCTION LIFT	26'	23'	26'	26'
TOTAL LIFT	82'	85'	85'	98'
ENGINE OIL TYPE	SAE 10W 30	SAE 10W 30	SAE 10W 30	SAE 10W 30
LOW OIL SHUTDOWN	YES	YES	YES	YES
FUEL TANK CAPACITY	3.1 L (0.82 US GAL)	3.1 L (0.82 US GAL)	3.1 L (0.82 US GAL)	6.1 L (1.6 US GAL)
HOUSING	ALUMINUM	ALUMINUM	ALUMINUM	ALUMINUM
IMPELLER	CAST IRON	CAST IRON	CAST IRON	CAST IRON
FITTINGS	2" NPT	3" NPT	3" NPT	4" NPT
SHIPPING (LxWxH)	21" X 17" X 19"	21" X 17" X 19"	21" X 17" X 19"	26" X 18" X 22"
WEIGHT	62 LBS	63 LBS	67 LBS	112 LBS
WARRANTY *FOR MANUFACTURE DEFECTS	2 YRS PUMP 3 YRS ENGINE	2 YRS PUMP 2 YRS ENGINE	2 YRS PUMP 3 YRS ENGINE	2 YRS PUMP 3 YRS ENGINE

TRASH PUMPS

POWERED by
HONDA
POWER EASE



PART #	TP-2065HT	TP-3070R	TP-3065HR	TP-3013HM	TP-4013HM
SERIES	WORKSHOP SERIES	COMMERCIAL SERIES	COMMERCIAL SERIES	INDUSTRIAL SERIES	INDUSTRIAL SERIES
PUMP TYPE	SEMI-TRASH	SEMI-TRASH	SEMI-TRASH	TRASH	TRASH
ENGINE TYPE	HONDA GX200	POWEEASE 225 CC	HONDA GX200	HONDA GX390	HONDA GX390
PORT SIZE INLET/OUTLET	2"	3"	3"	3"	4"
GPM	158	264	264	370	580
PSI	33	36	36	37	37
SUCTION LIFT	26'	26'	26'	26'	26'
TOTAL LIFT	85'	85'	85'	98'	95'
ENGINE OIL TYPE	SAE 10W 30	SAE 10W 30	SAE 10W 30	SAE 10W 30	SAE 10W 30
LOW OIL SHUTDOWN	YES	YES	YES	YES	YES
FUEL TANK CAPACITY	3.1 L (0.81 US GAL)	3.1 L (0.82 US GAL)	3.1 L (0.82 US GAL)	6.1 L (1.6 US GAL)	6.1 L (1.6 US GAL)
HOUSING	ALUMINUM	ALUMINUM	ALUMINUM	ALUMINUM	ALUMINUM
IMPELLER	CAST IRON	CAST IRON	CAST IRON	CAST IRON	CAST IRON
FITTINGS	2" NPT	3" NPT	3" NPT	3" NPT	4" NPT
CAPACITY FOR SOLIDS	UP TO 5/8"	UP TO 5/8"	UP TO 5/8"	UP TO 1"	UP TO 1"
SHIPPING (LxWxH)	21" X 17" X 19"	21" X 17" X 19"	21" X 17" X 19"	26" X 18" X 22"	26" X 18" X 22"
WEIGHT	80 LBS	90 LBS	90 LBS	144 LBS	152 LBS
WARRANTY *FOR MANUFACTURE DEFECTS	2 YRS PUMP 3 YRS ENGINE	2 YRS PUMP 2 YRS ENGINE	2 YRS PUMP 3 YRS ENGINE	2 YRS PUMP 3 YRS ENGINE	2 YRS PUMP 3 YRS ENGINE

NYLON PUMPS

POWERED by
HONDA
POWER EASE



PART #	NP-2070R	NP2065K	NP-3070R	NP-2065HR	NP-3065HR
SERIES	WORKSHOP <small>SERIES</small>	WORKSHOP <small>SERIES</small>	WORKSHOP <small>SERIES</small>	COMMERCIAL <small>SERIES</small>	COMMERCIAL <small>SERIES</small>
ENGINE TYPE	POWEREASE 225 CC	KOHLER SH270 196 CC	POWEREASE 225 CC	HONDA GX200	HONDA GX200
PORT SIZE - INLET/OUTLET	2"	2"	3"	2"	3"
GPM	154	154	265	154	265
PSI	40	40	37	40	37
SUCTION LIFT	26'	26'	26'	26'	26'
TOTAL LIFT	115'	115'	92'	115'	92'
ENGINE OIL TYPE	SAE 10W 30	SAE 10W 30	SAE 10W 30	SAE 10W 30	SAE 10W 30
LOW OIL SHUTDOWN	YES	YES	YES	YES	YES
FUEL TANK CAPACITY	3.1 L (0.82 US GAL)	3.3 L (0.85 US GAL)	3.1 L (0.82 US GAL)	3.1 L (0.82 US GAL)	3.1 L (0.82 US GAL)
HOUSING	30% FIBER / POLYESTER	30% FIBER / POLYESTER	30% FIBER / POLYESTER	30% FIBER / POLYESTER	30% FIBER / POLYESTER
IMPELLER	30% FIBER / POLYESTER	30% FIBER / POLYESTER	30% FIBER / POLYESTER	30% FIBER / POLYESTER	30% FIBER / POLYESTER
FITTINGS	STANDARD 2" NPT	STANDARD 2" NPT	STANDARD 3" NPT	STANDARD 2" NPT	STANDARD 3" NPT
SHIPPING (LxWxH)	21" X 17" X 19"	21" X 17" X 19"	21" X 17" X 19"	21" X 17" X 19"	21" X 17" X 19"
WEIGHT	60 LBS	60 LBS	64 LBS	60 LBS	64 LBS
WARRANTY <small>*FOR MANUFACTURE DEFECTS</small>	2 YRS PUMP 2 YRS ENGINE	2 YRS PUMP 2 YRS ENGINE	2 YRS PUMP 2 YRS ENGINE	2 YRS PUMP 3 YRS ENGINE	2 YRS PUMP 3 YRS ENGINE

HIGH PRESSURE PUMPS

POWERED by
HONDA
POWER EASE



US FORESTRY APPROVED

PART #	HP-2070R	HP-2065HR	HP-2013HR
SERIES	WORKSHOP <small>SERIES</small>	COMMERCIAL <small>SERIES</small>	COMMERCIAL <small>SERIES</small>
ENGINE TYPE	POWEREASE 225 CC	HONDA GX200	HONDA GX390
PORT SIZE - INLET/OUTLET	2"	2"	2"
GPM	126	126	126
PSI	85	85	143
SUCTION LIFT	26'	26'	26'
TOTAL LIFT	197'	197'	330'
ENGINE OIL TYPE	SAE 10W 30	SAE 10W 30	SAE 10W 30
LOW OIL SHUTDOWN	YES	YES	YES
FUEL TANK CAPACITY	3.1 L (0.82 US G)	3.1 L (0.82 US G)	6.1 L (1.6 US G)
HOUSING	ALUMINUM	ALUMINUM	CAST IRON
IMPELLER	ALUMINUM	ALUMINUM	ALUMINUM
FITTINGS	2" NPT	2" NPT	2" NPT
SHIPPING (LxWxH)	26" X 18" X 22"	26" X 18" X 22"	28" X 18" X 22"
WEIGHT	70 LBS	73 LBS	140 LBS
KIT WITH CART OPTION <small>*INCLUDES HOSES & NOZZLES</small>	HPFK-2070R	HPFC-2065HR	N/A
WARRANTY <small>*FOR MANUFACTURE DEFECTS</small>	2 YRS PUMP 2 YRS ENGINE	2 YRS PUMP 3 YRS ENGINE	2 YRS PUMP 3 YRS ENGINE

2" FIRE CART 196 CC HONDA GX200 ENGINE HPFC-2065HR

- Recoil start and low oil shutdown
- 2" Intake connection MNPT
- 2" Outlet connection MNPT
- 126 GPM max flow on pump
- Centrifugal aluminum pump
- Aluminum impeller
- 197' Total lift, 26' suction lift

INCLUDES

- 50' Fire hose, fire nozzle
- 12' Suction hose & foot valve

**SHOOTS
WATER
UP TO
85'**



SHIPPING INFORMATION

WEIGHT	130 LBS
UNITS/PALLET	2
DIMENSION (LxWxH)	30" X 29" X 23"



1-1/2" FIRE FIGHTING PUMP 196 CC HONDA GX200 ENGINE WS1565H

- Recoil start and low oil shutdown
- 78 GPM max flow
- 110 Psi max
- 120' Total lift, 26' suction lift
- 1 x 1-1/2" MNPSH inlet/outlet
- 2 x 1" outlet
- Spark arrestor



2" FIRE FIGHTING PUMP KIT 212 CC POWEREASE ENGINE HPFK-2070R

- Recoil start and low oil shutdown
- Fuel tank capacity 0.95 gal (3.6 L)
- 2" Intake connection MNPT
- 2" Outlet connection MNPT
- 126 GPM max flow on pump
- Centrifugal aluminum pump
- Heavy duty aluminum impeller
- 197' Total lift, 26' suction lift



INCLUDES

- 50' Fire hose, fire nozzle,
- 12' Suction hose & foot valve



SHIPPING INFORMATION

WEIGHT	86 LBS
UNITS/PALLET	6
DIMENSION (LxWxH)	28" X 20" X 18"

SUCTION HOSE SET 50.400.000



INCLUDES

- 1 x 1-1/2" X 20 UL approved non-collapsible suction hose
- 1 x 1-1/2" Suction strainer
- 1 x 1-1/2" Type A camlock

FIRE HOSE DISCHARGE SET 50.400.001



INCLUDES

- 1 x 1-1/2" x 50' lay-flat fire hose w/FHT ends
- 1 x 1-1/2" FHT adaptor
- 1 x 1-1/2" UL approved fog nozzle

BOOSTER HOSE SET 50.400.002



INCLUDES

- 1 x 1" x 50' lay flat UL approved garden hose with FHT ends
- 1 x UL approved spot/booster nozzle with FHT to GHT conversion end

POWER EASE



MODEL #	SP-500TD	SP-600BD	SP-650BD	SP-550SD
SERIES	WORKSHOP SERIES	WORKSHOP SERIES	WORKSHOP SERIES	WORKSHOP SERIES
MOTOR	0.5 HP	0.5 HP	0.5 HP	0.5 HP
TOTAL LIFT	28-1/2'	26'	26'	28-1/2'
FLOW @ 0'	1508 GPH	3036 GPH	3036 GPH	2905 GPH
FLOW @ 10'	900 GPH	2100 GPH	2100 GPH	2000 GPH
FLOW @ 20'	250 GPH	540 GPH	540 GPH	495 GPH
OUTLET PORT	3/4"	1-1/2"	1-1/2"	1-1/2"
DISCHARGE PORT	VERTICAL	VERTICAL	VERTICAL	VERTICAL
DISCHARGE LOCATION	TOP	BOTTOM	BOTTOM	SIDE/BOTTOM
ON/OFF	PLUG ONLY	VERTICAL	TETHERED	TETHERED
VOLTAGE	120V	120V	120V	120V
CABLE LENGTH	15'	15'	15'	25'
HOUSING	THERMOPLASTIC	THERMOPLASTIC	THERMOPLASTIC	THERMOPLASTIC
SOLIDS	2 MM/ .08"	2 MM/ .08"	2 MM/ .08"	2 MM/ .08"
SHIPPING (LxWxH)	7" X 8" X 12"	8" X 8" X 12"	8" X 8" X 12"	8" X 8" X 12"
WARRANTY	1 YR	1 YR	1 YR	1 YR
WEIGHT	8 LBS	10 LBS	10 LBS	10 LBS

POWER EASE



MODEL #	SP-750TD	ST-900SD	SP-900SD
SERIES	WORKSHOP SERIES	WORKSHOP SERIES	WORKSHOP SERIES
MOTOR	0.75 HP	1 HP	1.5 HP
TOTAL LIFT	28'	36'	29.5'
FLOW @ 0'	2420 GPH	3434 GPH	3410 GPH
FLOW @ 10'	1580 GPH	2395 GPH	2299 GPH
FLOW @ 20'	397 GPH	1165 GPH	1121 GPH
OUTLET PORT	1-1/2"	1-1/2"	1-1/2"
DISCHARGE PORT	VERTICAL	VERTICAL	VERTICAL
DISCHARGE LOCATION	TOP	SIDE/BOTTOM	SIDE/BOTTOM
ON/OFF	TETHERED	TETHERED	TETHERED
VOLTAGE	120V	120V	120V
CABLE LENGTH	25'	25'	25'
HOUSING	STAINLESS STEEL	STAINLESS STEEL	STAINLESS STEEL
SOLIDS	2 MM/ .08"	2 MM/ .08"	6.35 MM/ .25"
SHIPPING (LxWxH)	8" X 9" X 15"	8" X 9" X 15"	8" X 9" X 15"
WARRANTY	1 YR	1 YR	1 YR
WEIGHT	15 LBS	15 LBS	15 LBS

DISCHARGE HOSES & ACCESSORIES



WATER PUMP DISCHARGE HOSE KITS (BLUE)

PART#	SIZE	LENGTH	TEMP	PRESSURE:
85.400.084	1"	50'	150°F	80 PSI
85.400.085	2"	50'	150°F	80 PSI
85.400.086	3"	50'	150°F	65 PSI
85.400.087	4"	50'	150°F	55 PSI

WATER PUMP DISCHARGE HOSE KITS (RED)

PART#	SIZE	LENGTH	TEMP	PRESSURE:
85.400.098	3"	50'	150°F	150 PSI

SUCTION HOSE KITS

85.400.088



SUCTION HOSE KITS

PART#	SIZE	LENGTH	CAMLOCK	STRAINER
85.400.088	1"	25'	ALUMINUM	NYLON
85.400.089	2"	25'	ALUMINUM	STEEL
85.400.090	3"	25'	ALUMINUM	STEEL
85.400.091	4"	25'	ALUMINUM	NYLON

TRASH PUMP REPLACEMENT STRAINERS

50.002.014



REPLACEMENT STRAINERS

PART#	SIZE	MATERIAL
50.002.014	2"	METAL
50.103.205	3"	METAL
50.103.404	4"	METAL

WATER PUMP METAL REPLACEMENT STRAINER

50.002.012



REPLACEMENT STRAINERS

PART#	SIZE	MATERIAL
50.002.012	2"	STEEL

WATER PUMP PLASTIC REPLACEMENT STRAINERS

50.002.400



REPLACEMENT STRAINERS

PART#	SIZE	MATERIAL
50.002.400	2"	PLASTIC
50.003.400	3"	PLASTIC
50.004.400	4"	PLASTIC

BOXED PUMP ASSEMBLIES

PART#	DESCRIPTION
85.120.035B	2.5 GPM, BRASS HEAD
85.149.079B	4.0 GPM, 34000 RPM
85.149.085B	3.0 GPM, 34000 RPM, 2700 PSI

BOXED PUMP
4.0 GPM, 34000 RPM
 85.149.079B



ACCESSORY KITS

PART#	DESCRIPTION
85.400.000	3 PIECE MULTI FLOW CHEMICAL INJECTOR KIT
85.400.118	PUMP PLUMBING KIT
85.400.202	COUPLER & PLUG KIT
85.400.203	O-RING & FILTER KIT
85.400.204	M22 FITTINGS KIT (14 PIECES)
85.400.210	MNPT COUPLER KIT (14 PIECES)

COUPLER & PLUG KIT
 85.400.202



O-RING & FILTER KIT
 85.400.203



NOZZLE SETS

PART#	DESCRIPTION
85.210.030	#030 NOZZLE SET
85.210.035	#035 NOZZLE SET
85.210.040	#040 NOZZLE SET
85.210.045	#045 NOZZLE SET
85.210.140	#4.0 ROTARY NOZZLE SET

#030 NOZZLE SET
 85.210.030



COUPLERS & PLUGS

PART#	DESCRIPTION
85.300.101	1/4" QD STEEL PLUG
85.300.102	1/4" QC BRASS COUPLER
85.300.103	3/8" QC BRASS COUPLER
85.300.104	3/8" QD STEEL PLUG

STEEL PLUG
1/4" QD FNPT
 85.300.101



50' HOSE
4000 PSI, 3/8"
 85.238.153



WATER INLET FILTER
1/2" MNPT X 3/4" FNPT
 85.300.056



INSULATED STRAIGHT LANCE
INCLUDES GUN, WAND & COUPLER
900 MM / 36"
 85.205.026



ECONOMY ACCESSORY SET
INCLUDES GUN, LANCE,
VARI-NOZZLE & 25' HOSE
 85.400.320











PUMP OIL
1 L / 0.26 GAL
 85.490.000



ANTIFREEZE
16 OZ
 85.490.046



POLYPROPYLENE CAMLOCK FITTINGS

								
	MALE COUPLER X FPT	FEMALE COUPLER X MPT	MALE BARB X FEMALE COUPLER	FEMALE COUPLER X FPT	MALE BARB X MALE COUPLER	MALE COUPLER X MPT	DUST PLUG	DUST CAP
TYPE	A	B	C	D	E	F	DP	DC
3/4" PART#	90.720.034	90.721.034	90.722.034	90.723.034	90.724.034	90.725.034	90.727.034	90.726.034
1" PART#	90.720.100	90.721.100	90.722.100	90.723.100	90.724.100	90.725.100	90.727.100	90.726.100
1-1/4" PART#	90.720.114	90.721.114	90.722.114	90.723.114	90.724.114	90.725.114	90.727.114	90.726.114
1-1/2" PART#	90.720.112	90.721.112	90.722.112	90.723.112	90.724.112	90.725.112	90.727.112	90.726.112
2" PART#	90.737.040	90.737.300	90.737.360	90.737.240	90.737.160	90.737.100	90.737.440	90.737.500
3" PART#	90.720.300	90.721.300	90.722.300	90.723.300	90.724.300	90.725.300	90.727.300	90.726.300

ALUMINUM CAMLOCK FITTINGS

								
	MALE COUPLER X FPT	FEMALE COUPLER X MPT	MALE BARB X FEMALE COUPLER	FEMALE COUPLER X FPT	MALE BARB X MALE COUPLER	MALE COUPLER X MPT	DUST PLUG	DUST CAP
TYPE	A	B	C	D	E	F	DP	DC
3/4" PART#	90.390.034	90.391.034	90.392.034	90.393.034	90.394.034	90.395.034	90.397.034	90.396.034
1" PART#	90.390.100	90.391.100	90.392.100	90.393.100	90.394.100	90.395.100	90.397.100	90.396.100
1-1/4" PART#	90.390.114	90.391.114	90.392.114	90.393.114	90.394.114	90.395.114	90.397.114	90.396.114
1-1/2" PART#	90.390.112	90.391.112	90.392.112	90.393.112	90.394.112	90.395.112	90.397.112	90.396.112
2" PART#	90.390.200	90.391.200	90.392.200	90.393.200	90.394.200	90.395.200	90.397.200	90.396.200
3" PART#	90.390.300	90.391.300	90.392.300	90.393.300	90.394.300	90.395.300	90.397.300	90.396.300
4" PART#	-	90.391.400	90.392.400	90.393.400	90.394.400	90.395.400	-	-

**1/2" FNPT FULL PORT
BRASS BALL VALVE**
91.000.003



BRASS BALL VALVES, NON CSA, FULL PORT, 1/4 TURN

PART#	PSI	SIZE	THREAD
91.000.001	600 WOG	1/4"	FNPT
91.000.002	600 WOG	3/8"	FNPT
91.000.003	600 WOG	1/2"	FNPT
91.000.004	600 WOG	3/4"	FNPT
91.000.005	600 WOG	1"	FNPT
91.000.006	600 WOG	1-1/4"	FNPT
91.000.007	600 WOG	1-1/2"	FNPT
91.000.008	600 WOG	2"	FNPT
91.000.010	600 WOG	3"	FNPT
91.000.012	600 WOG	4"	FNPT

**1/4" FNPT 316 STAINLESS STEEL
LOCKING HANDLE BALL VALVE**
91.200.001



316 STAINLESS STEEL, LOCKING HANDLE BALL VALVES

PART#	PSI	SIZE	THREAD
91.200.001	1000 WOG	1/4"	FNPT
91.200.002	1000 WOG	3/8"	FNPT
91.200.003	1000 WOG	1/2"	FNPT
91.200.004	1000 WOG	3/4"	FNPT
91.200.005	1000 WOG	1"	FNPT
91.200.006	1000 WOG	1-1/4"	FNPT
91.200.007	1000 WOG	1-1/2"	FNPT
91.200.008	1000 WOG	2"	FNPT
91.200.009	1000 WOG	2-1/2"	FNPT
91.200.010	1000 WOG	3"	FNPT

**1/2" FNPT FULL PORT
BRASS GATE VALVE**
92.000.003



BRASS GATE VALVES, FULL PORT

PART#	PSI	SIZE	THREAD
92.000.003	200	1/2"	FNPT
92.000.004	200	3/4"	FNPT
92.000.005	200	1"	FNPT
92.000.006	200	1-1/4"	FNPT
92.000.007	200	1-1/2"	FNPT
92.000.008	200	2"	FNPT
92.000.009	200	2-1/2"	FNPT
92.000.010	200	3"	FNPT
92.000.012	200	4"	FNPT

**1" SOLDER BRASS
SWEAT BALL VALVE**
91.500.005



UL APPROVED

BRASS SWEAT BALL VALVES, FULL PORT, SOLDER ENDS

PART#	PSI	SIZE	THREAD
91.500.005	600	1"	SOLDER
91.500.006*	600	1-1/4"	SOLDER
91.500.007*	600	1-1/2"	SOLDER
91.500.008*	600	2"	SOLDER

*LIMITED STOCK

3/8" MNPT X 1/2" MBSP BSP BALL VALVE

91.150.140



BSP BALL VALVES, NICKEL PLATED BRASS

PART#	SIZE / THREAD
91.150.140	3/8" MNPT X 1/2" MBSP
91.150.150	1/2" MNPT X 1/2" MBSP

1/4" FNPT X 1/4" FNPT CHROMED LEVER MINI BALL VALVE

91.400.001

- Chromed Brass Body/Ball/Stem
- Teflon Seat,
- Viton Seals



LEVER MINI BALL VALVES, CHROMED BRASS

PART#	PSI	SIZE	THREAD
91.400.001	200	1/4"	FNPT
91.401.001	200	1/4"	FNPT
91.400.002	200	3/8"	FNPT
91.401.002	200	3/8"	FNPT
91.400.003	200	1/2"	FNPT
91.401.003	200	1/2"	FNPT

1/4" FNPT X 1/4" FNPT CHROMED T-HANDLE MINI BALL VALVE

91.400.101

- Chromed Brass Body/Ball/Stem
- Teflon Seat,
- Viton Seals



T-HANDLE MINI BALL VALVES, CHROMED BRASS

PART#	PSI	SIZE	THREAD
91.400.101	200	1/4" X 1/4"	FNPT X FNPT
91.401.101	200	1/4" X 1/4"	MNPT X FNPT
91.400.102	200	3/8" X 3/8"	FNPT X FNPT
91.401.102	200	3/8" X 3/8"	MNPT X FNPT
91.400.103	200	1/2" X 1/2"	FNPT X FNPT
91.401.103	200	1/2" X 1/2"	MNPT X FNPT

1/4" MNPT X 11/16" M NOZZLE THREAD NOZZLE BALL VALVE

91.900.156



NOZZLE BALL VALVES, BRASS

PART#	SIZE / THREAD
91.900.056	1/4" FNPT X 11/16" M NOZZLE THREAD
91.900.156	1/4" MNPT X 11/16" M NOZZLE THREAD

SERIES 20

DUAL SCALE. ASME/ANSI B40.1 GRADE B (3-2-3%) THESE GAUGES ARE DESIGNED FOR USE WITH GAS, OIL, AND WATER OR ANY MEDIUM NOT CORROSIVE TO BRASS OR BRONZE.

SERIES 24

SINGLE SCALE. ASME/ANSI B40.1 GRADE B (3-2-3%) THESE GAUGES ARE DESIGNED FOR USE WITH GAS, OIL, AND WATER OR ANY MEDIUM NOT CORROSIVE TO BRASS OR BRONZE.

SERIES 40

DUAL SCALE. ASME/ANSI B40.1 GRADE A (2-1-2%) THESE GAUGES ARE DESIGNED FOR USE WITH ANY MEDIUM NOT CORROSIVE TO BRASS OR BRONZE. LIQUID-FILLED GAUGES ARE RECOMMENDED FOR REDUCING SHOCK CAUSED BY PRESSURE FLUCTUATIONS OR VIBRATION (STANDARD).

SERIES 41

SINGLE SCALE. ASME/ANSI B40.1 GRADE B (3-2-3%) THESE GAUGES ARE DESIGNED FOR USE WITH ANY MEDIUM NOT CORROSIVE TO BRASS OR BRONZE. LIQUID-FILLED GAUGES ARE RECOMMENDED FOR REDUCING SHOCK CAUSED BY PRESSURE FLUCTUATIONS OR VIBRATION.

SERIES 54

SINGLE SCALE. ASME/ANSI B40.1 GRADE B (3-2-3%) THESE GAUGES ARE DESIGNED FOR USE WITH ANY MEDIUM NOT CORROSIVE TO STAINLESS STEEL. LIQUID-FILLED GAUGES ARE RECOMMENDED FOR REDUCING SHOCK CAUSED BY PRESSURE FLUCTUATIONS OR VIBRATION.

SERIES 80

SINGLE SCALE. ASME/ANSI B40.1 GRADE A (2-1-2%) THIS RUGGED PRODUCT EMPLOYS A 316 STAINLESS STEEL BOURDON TUBE, ASME GRADE A MOVEMENT, AND A STAINLESS STEEL SOCKET ALL HOUSED IN A CORROSIVE RESISTANT PAINTED STEEL CASE.

SERIES 20

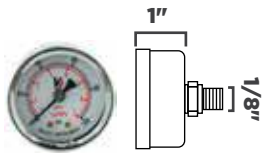

1-1/2" REAR MOUNT DRY GAUGE

PART #	DIAL SIZE	CASE/MOUNT STYLE	FILL MATERIAL	CASE MATERIAL	CONNECTION MATERIAL	PSI
85.410.060	1-1/2"	REAR	DRY	BLACK STEEL	BRASS	0 - 60
85.410.100	1-1/2"	REAR	DRY	BLACK STEEL	BRASS	0 - 100
85.410.160	1-1/2"	REAR	DRY	BLACK STEEL	BRASS	0 - 160
85.410.200	1-1/2"	REAR	DRY	BLACK STEEL	BRASS	0 - 200

RETAIL VERSIONS

85.410.200BP	1-1/2"	REAR	DRY	BLACK STEEL	BRASS	0 - 200
--------------	--------	------	-----	-------------	-------	---------

SERIES 20

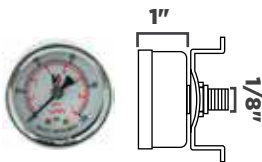

1-1/2" PANEL MOUNT DRY GAUGE

PART #	DIAL SIZE	CASE/MOUNT STYLE	FILL MATERIAL	CASE MATERIAL	CONNECTION MATERIAL	PSI
85.411.015	1-1/2"	PANEL	DRY	BLACK STEEL	BRASS	0 - 15
85.411.060	1-1/2"	PANEL	DRY	BLACK STEEL	BRASS	0 - 60
85.411.160	1-1/2"	PANEL	DRY	BLACK STEEL	BRASS	0 - 160
85.411.200	1-1/2"	PANEL	DRY	BLACK STEEL	BRASS	0 - 200

WITH MOUNTING BRACKET

SERIES 20

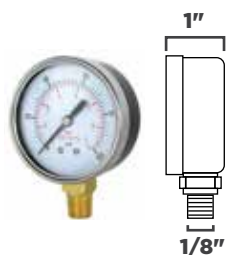

1-1/2" BOTTOM MOUNT DRY GAUGE

PART #	DIAL SIZE	CASE/MOUNT STYLE	FILL MATERIAL	CASE MATERIAL	CONNECTION MATERIAL	PSI
85.415.015	1-1/2"	BOTTOM	DRY	BLACK STEEL	BRASS	0 - 15
85.415.060	1-1/2"	BOTTOM	DRY	BLACK STEEL	BRASS	0 - 60
85.415.100	1-1/2"	BOTTOM	DRY	BLACK STEEL	BRASS	0 - 100
85.415.160	1-1/2"	BOTTOM	DRY	BLACK STEEL	BRASS	0 - 160
85.415.200	1-1/2"	BOTTOM	DRY	BLACK STEEL	BRASS	0 - 200

RETAIL VERSIONS

85.415.100BP	1-1/2"	BOTTOM	DRY	BLACK STEEL	BRASS	0 - 100
85.415.200BP	1-1/2"	BOTTOM	DRY	BLACK STEEL	BRASS	0 - 200

SERIES 20

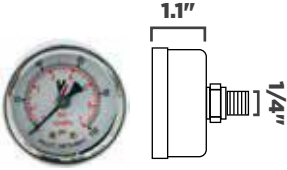

2" REAR MOUNT DRY GAUGE

PART #	DIAL SIZE	CASE/MOUNT STYLE	FILL MATERIAL	CASE MATERIAL	CONNECTION MATERIAL	PSI
85.420.100	2"	REAR	DRY	BLACK STEEL	BRASS	0 - 100
85.420.200	2"	REAR	DRY	BLACK STEEL	BRASS	0 - 200
85.420.300	2"	REAR	DRY	BLACK STEEL	BRASS	0 - 300

RETAIL VERSIONS

85.420.200BP	2"	REAR	DRY	BLACK STEEL	BRASS	0 - 200
--------------	----	------	-----	-------------	-------	---------

SERIES 20

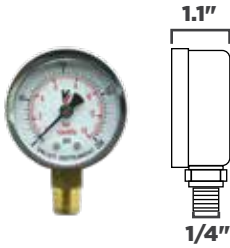

2" BOTTOM MOUNT DRY GAUGE

PART #	DIAL SIZE	CASE/MOUNT STYLE	FILL MATERIAL	CASE MATERIAL	CONNECTION MATERIAL	PSI
85.040.200	2"	BOTTOM	DRY	BLACK STEEL	BRASS	0 - 200

SERIES 20



4" BOTTOM MOUNT DRY GAUGE

PART #	DIAL SIZE	CASE/MOUNT STYLE	FILL MATERIAL	CASE MATERIAL	CONNECTION MATERIAL	PSI
85.800.030	4"	BOTTOM	DRY	BLACK STEEL	BRASS	VACUUM -30HG - 30

SERIES 24

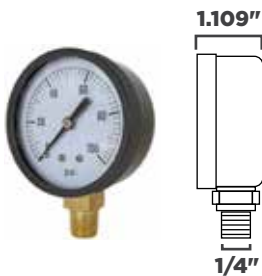

2" BOTTOM MOUNT DRY GAUGE

PART #	DIAL SIZE	CASE/MOUNT STYLE	FILL MATERIAL	CASE MATERIAL	CONNECTION MATERIAL	PSI
85.400.015	2"	BOTTOM	DRY	ABS	BRASS	0 - 15
85.400.030	2"	BOTTOM	DRY	ABS	BRASS	0 - 30
85.401.060	2"	BOTTOM	DRY	ABS	BRASS	0 - 60
85.400.100	2"	BOTTOM	DRY	ABS	BRASS	0 - 100
85.400.160	2"	BOTTOM	DRY	ABS	BRASS	0 - 160
85.401.200	2"	BOTTOM	DRY	ABS	BRASS	0 - 200
85.400.300	2"	BOTTOM	DRY	ABS	BRASS	0 - 300
85.400.400	2"	BOTTOM	DRY	ABS	BRASS	0 - 400

RETAIL VERSIONS

85.400.200BP	2"	BOTTOM	DRY	ABS	BRASS	0 - 200
--------------	----	--------	-----	-----	-------	---------

SERIES 24



2-1/2" BOTTOM MOUNT DRY GAUGE

PART #	DIAL SIZE	CASE/MOUNT STYLE	FILL MATERIAL	CASE MATERIAL	CONNECTION MATERIAL	PSI
85.500.030	2-1/2"	BOTTOM	DRY	ABS	BRASS	0 - 30
85.500.060	2-1/2"	BOTTOM	DRY	ABS	BRASS	0 - 60
85.500.100	2-1/2"	BOTTOM	DRY	ABS	BRASS	0 - 100
85.500.160	2-1/2"	BOTTOM	DRY	ABS	BRASS	0 - 160
85.500.200	2-1/2"	BOTTOM	DRY	ABS	BRASS	0 - 200
85.500.400	2-1/2"	BOTTOM	DRY	ABS	BRASS	0 - 400
85.500.600	2-1/2"	BOTTOM	DRY	ABS	BRASS	0 - 600

SERIES 40

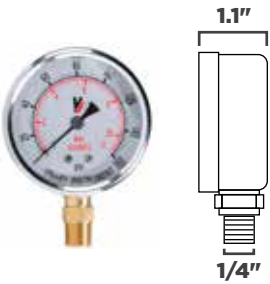

2-1/5" BOTTOM MOUNT GLYCERIN GAUGE

PART #	DIAL SIZE	CASE/MOUNT STYLE	FILL MATERIAL	CASE MATERIAL	CONNECTION MATERIAL	PSI
85.200.060	2-1/2"	BOTTOM	GLYCERIN	STAINLESS STEEL	BRASS	0 - 60
85.200.100	2-1/2"	BOTTOM	GLYCERIN	STAINLESS STEEL	BRASS	0 - 100
85.200.300	2-1/2"	BOTTOM	GLYCERIN	STAINLESS STEEL	BRASS	0 - 300

SERIES 40

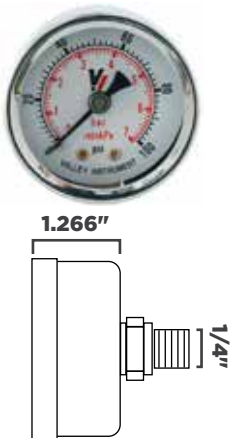

4" REAR MOUNT GLYCERIN GAUGE

PART #	DIAL SIZE	CASE/MOUNT STYLE	FILL MATERIAL	CASE MATERIAL	CONNECTION MATERIAL	PSI
84.910.100	4"	REAR	GLYCERIN	STAINLESS STEEL	BRASS	0 - 100
84.910.160	4"	REAR	GLYCERIN	STAINLESS STEEL	BRASS	0 - 160
84.910.200	4"	REAR	GLYCERIN	STAINLESS STEEL	BRASS	0 - 200
84.910.300	4"	REAR	GLYCERIN	STAINLESS STEEL	BRASS	0 - 300
84.910.600	4"	REAR	GLYCERIN	STAINLESS STEEL	BRASS	0 - 600
84.911.000	4"	REAR	GLYCERIN	STAINLESS STEEL	BRASS	0 - 1000
84.912.000	4"	REAR	GLYCERIN	STAINLESS STEEL	BRASS	0 - 2000

SERIES 40

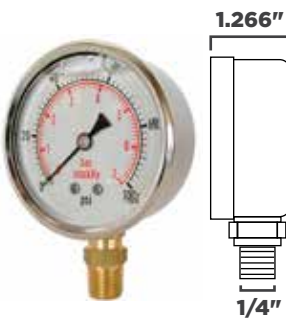

4" BOTTOM MOUNT GLYCERIN GAUGE

PART #	DIAL SIZE	CASE/MOUNT STYLE	FILL MATERIAL	CASE MATERIAL	CONNECTION MATERIAL	PSI
84.000.003	4"	BOTTOM	GLYCERIN	STAINLESS STEEL	BRASS	VACUUM -30 - 30
84.000.006	4"	BOTTOM	GLYCERIN	STAINLESS STEEL	BRASS	VACUUM -30 - 60

SERIES 40

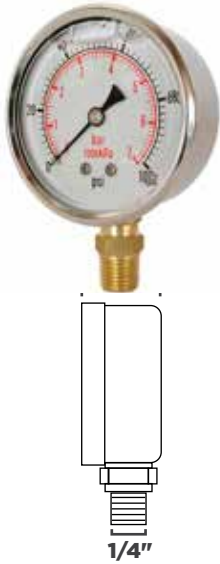

4" BOTTOM MOUNT GLYCERIN GAUGE

PART #	DIAL SIZE	CASE/MOUNT STYLE	FILL MATERIAL	CASE MATERIAL	CONNECTION MATERIAL	PSI
84.000.015	4"	BOTTOM	GLYCERIN	STAINLESS STEEL	BRASS	0 - 15
84.000.030	4"	BOTTOM	GLYCERIN	STAINLESS STEEL	BRASS	0 - 30
84.000.060	4"	BOTTOM	GLYCERIN	STAINLESS STEEL	BRASS	0 - 60
84.000.100	4"	BOTTOM	GLYCERIN	STAINLESS STEEL	BRASS	0 - 100
84.000.160	4"	BOTTOM	GLYCERIN	STAINLESS STEEL	BRASS	0 - 160
84.000.200	4"	BOTTOM	GLYCERIN	STAINLESS STEEL	BRASS	0 - 200
84.000.300	4"	BOTTOM	GLYCERIN	STAINLESS STEEL	BRASS	0 - 300
84.000.400	4"	BOTTOM	GLYCERIN	STAINLESS STEEL	BRASS	0 - 400
84.000.600	4"	BOTTOM	GLYCERIN	STAINLESS STEEL	BRASS	0 - 600
84.001.000	4"	BOTTOM	GLYCERIN	STAINLESS STEEL	BRASS	0 - 1000
84.003.000	4"	BOTTOM	GLYCERIN	STAINLESS STEEL	BRASS	0 - 3000
84.005.000	4"	BOTTOM	GLYCERIN	STAINLESS STEEL	BRASS	0 - 5000
84.010.000	4"	BOTTOM	GLYCERIN	STAINLESS STEEL	BRASS	0 - 10000

SERIES 41

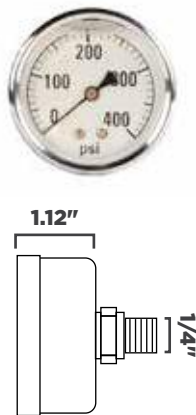

2-1/2" REAR MOUNT GLYCERIN GAUGE

PART #	DIAL SIZE	CASE/MOUNT STYLE	FILL MATERIAL	CASE MATERIAL	CONNECTION MATERIAL	PSI
85.910.030	2-1/2"	REAR	GLYCERIN	STAINLESS STEEL	BRASS	0 - 30
85.910.060	2-1/2"	REAR	GLYCERIN	STAINLESS STEEL	BRASS	0 - 60
85.910.100	2-1/2"	REAR	GLYCERIN	STAINLESS STEEL	BRASS	0 - 100
85.910.160	2-1/2"	REAR	GLYCERIN	STAINLESS STEEL	BRASS	0 - 160
85.910.200	2-1/2"	REAR	GLYCERIN	STAINLESS STEEL	BRASS	0 - 200
85.910.300	2-1/2"	REAR	GLYCERIN	STAINLESS STEEL	BRASS	0 - 300
85.910.600	2-1/2"	REAR	GLYCERIN	STAINLESS STEEL	BRASS	0 - 600
85.911.000	2-1/2"	REAR	GLYCERIN	STAINLESS STEEL	BRASS	0 - 1000
85.913.000	2-1/2"	REAR	GLYCERIN	STAINLESS STEEL	BRASS	0 - 3000
85.915.000	2-1/2"	REAR	GLYCERIN	STAINLESS STEEL	BRASS	0 - 5000

SERIES 41

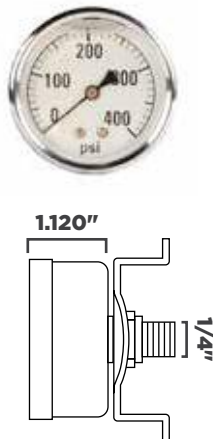

2-1/2" PANEL MOUNT GLYCERIN GAUGE

PART #	DIAL SIZE	CASE/MOUNT STYLE	FILL MATERIAL	CASE MATERIAL	CONNECTION MATERIAL	PSI
85.900.030	2-1/2"	PANEL	GLYCERIN	STAINLESS STEEL	BRASS	0 - 30
85.900.060	2-1/2"	PANEL	GLYCERIN	STAINLESS STEEL	BRASS	0 - 60
85.900.100	2-1/2"	PANEL	GLYCERIN	STAINLESS STEEL	BRASS	0 - 100
85.900.160	2-1/2"	PANEL	GLYCERIN	STAINLESS STEEL	BRASS	0 - 160
85.900.200	2-1/2"	PANEL	GLYCERIN	STAINLESS STEEL	BRASS	0 - 200
85.900.300	2-1/2"	PANEL	GLYCERIN	STAINLESS STEEL	BRASS	0 - 300
85.900.400	2-1/2"	PANEL	GLYCERIN	STAINLESS STEEL	BRASS	0 - 400
85.900.600	2-1/2"	PANEL	GLYCERIN	STAINLESS STEEL	BRASS	0 - 600
85.901.000	2-1/2"	PANEL	GLYCERIN	STAINLESS STEEL	BRASS	0 - 1000
85.903.000	2-1/2"	PANEL	GLYCERIN	STAINLESS STEEL	BRASS	0 - 3000
85.905.000	2-1/2"	PANEL	GLYCERIN	STAINLESS STEEL	BRASS	0 - 5000

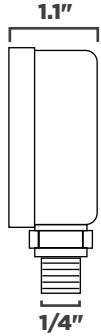

RETAIL VERSION

2-1/2" BOTTOM MOUNT GLYCERIN GAUGE

PART #	DIAL SIZE	CASE/MOUNT STYLE	FILL MATERIAL	CASE MATERIAL	CONNECTION MATERIAL	PSI
85.300.015	2-1/2"	BOTTOM	GLYCERIN	STAINLESS STEEL	BRASS	0 - 15
85.300.030	2-1/2"	BOTTOM	GLYCERIN	STAINLESS STEEL	BRASS	0 - 30
85.300.060	2-1/2"	BOTTOM	GLYCERIN	STAINLESS STEEL	BRASS	0 - 60
85.300.100	2-1/2"	BOTTOM	GLYCERIN	STAINLESS STEEL	BRASS	0 - 100
85.300.160	2-1/2"	BOTTOM	GLYCERIN	STAINLESS STEEL	BRASS	0 - 160
85.300.200	2-1/2"	BOTTOM	GLYCERIN	STAINLESS STEEL	BRASS	0 - 200
85.300.300	2-1/2"	BOTTOM	GLYCERIN	STAINLESS STEEL	BRASS	0 - 300
85.300.400	2-1/2"	BOTTOM	GLYCERIN	STAINLESS STEEL	BRASS	0 - 400
85.300.600	2-1/2"	BOTTOM	GLYCERIN	STAINLESS STEEL	BRASS	0 - 600
85.301.000	2-1/2"	BOTTOM	GLYCERIN	STAINLESS STEEL	BRASS	0 - 1000
85.302.000	2-1/2"	BOTTOM	GLYCERIN	STAINLESS STEEL	BRASS	0 - 2000
85.303.000	2-1/2"	BOTTOM	GLYCERIN	STAINLESS STEEL	BRASS	0 - 3000
85.305.000	2-1/2"	BOTTOM	GLYCERIN	STAINLESS STEEL	BRASS	0 - 5000
85.310.000	2-1/2"	BOTTOM	GLYCERIN	STAINLESS STEEL	BRASS	0 - 10000

RETAIL VERSIONS

85.300.015BP	2-1/2"	BOTTOM	GLYCERIN	STAINLESS STEEL	BRASS	0 - 15
85.300.030BP	2-1/2"	BOTTOM	GLYCERIN	STAINLESS STEEL	BRASS	0 - 30
85.300.060BP	2-1/2"	BOTTOM	GLYCERIN	STAINLESS STEEL	BRASS	0 - 60
85.300.100BP	2-1/2"	BOTTOM	GLYCERIN	STAINLESS STEEL	BRASS	0 - 100
85.300.160BP	2-1/2"	BOTTOM	GLYCERIN	STAINLESS STEEL	BRASS	0 - 160
85.300.200BP	2-1/2"	BOTTOM	GLYCERIN	STAINLESS STEEL	BRASS	0 - 200
85.300.300BP	2-1/2"	BOTTOM	GLYCERIN	STAINLESS STEEL	BRASS	0 - 300
85.300.400BP	2-1/2"	BOTTOM	GLYCERIN	STAINLESS STEEL	BRASS	0 - 400
85.300.600BP	2-1/2"	BOTTOM	GLYCERIN	STAINLESS STEEL	BRASS	0 - 600
85.301.000BP	2-1/2"	BOTTOM	GLYCERIN	STAINLESS STEEL	BRASS	0 - 1000
85.302.000BP	2-1/2"	BOTTOM	GLYCERIN	STAINLESS STEEL	BRASS	0 - 2000
85.303.000BP	2-1/2"	BOTTOM	GLYCERIN	STAINLESS STEEL	BRASS	0 - 3000
85.305.000BP	2-1/2"	BOTTOM	GLYCERIN	STAINLESS STEEL	BRASS	0 - 5000
85.310.000BP	2-1/2"	BOTTOM	GLYCERIN	STAINLESS STEEL	BRASS	0 - 10000

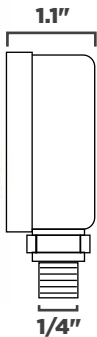

2-1/2" BOTTOM MOUNT GLYCERIN GAUGE - VACUUM

PART #	DIAL SIZE	CASE/MOUNT STYLE	FILL MATERIAL	CASE MATERIAL	CONNECTION MATERIAL	PSI
85.310.030	2-1/2"	BOTTOM	GLYCERIN	STAINLESS STEEL	BRASS	VACUUM -30 - 30
85.310.060	2-1/2"	BOTTOM	GLYCERIN	STAINLESS STEEL	BRASS	VACUUM -30 - 60
85.310.150	2-1/2"	BOTTOM	GLYCERIN	STAINLESS STEEL	BRASS	VACUUM -30 - 150

SERIES 41

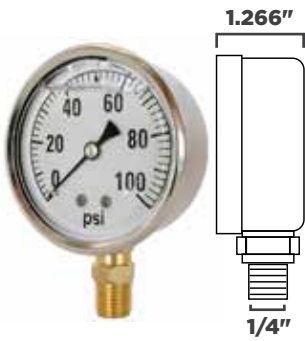

4" BOTTOM MOUNT GLYCERIN GAUGE

PART #	DIAL SIZE	CASE/MOUNT STYLE	FILL MATERIAL	CASE MATERIAL	CONNECTION MATERIAL	PSI
84.500.200	4"	BOTTOM	GLYCERIN	STAINLESS STEEL	BRASS	0 - 200

SERIES 54

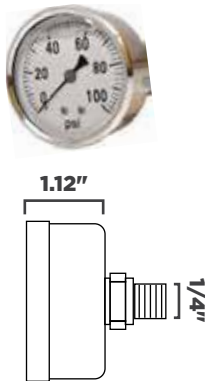

2-1/2" REAR MOUNT GLYCERIN GAUGE

PART #	DIAL SIZE	CASE/MOUNT STYLE	FILL MATERIAL	CASE MATERIAL	CONNECTION MATERIAL	PSI
85.355.030	2-1/2"	REAR	GLYCERIN	STAINLESS STEEL	STAINLESS STEEL	0 - 30
85.355.060	2-1/2"	REAR	GLYCERIN	STAINLESS STEEL	STAINLESS STEEL	0 - 60
85.355.100	2-1/2"	REAR	GLYCERIN	STAINLESS STEEL	STAINLESS STEEL	0 - 100
85.355.200	2-1/2"	REAR	GLYCERIN	STAINLESS STEEL	STAINLESS STEEL	0 - 200

SERIES 54



2-1/2" BOTTOM MOUNT GLYCERIN GAUGE

PART #	DIAL SIZE	CASE/MOUNT STYLE	FILL MATERIAL	CASE MATERIAL	CONNECTION MATERIAL	PSI
85.350.030	2-1/2"	BOTTOM	GLYCERIN	STAINLESS STEEL	STAINLESS STEEL	0 - 30
85.350.060	2-1/2"	BOTTOM	GLYCERIN	STAINLESS STEEL	STAINLESS STEEL	0 - 60
85.350.100	2-1/2"	BOTTOM	GLYCERIN	STAINLESS STEEL	STAINLESS STEEL	0 - 100
85.350.160	2-1/2"	BOTTOM	GLYCERIN	STAINLESS STEEL	STAINLESS STEEL	0 - 160
85.350.200	2-1/2"	BOTTOM	GLYCERIN	STAINLESS STEEL	STAINLESS STEEL	0 - 200

SERIES 54

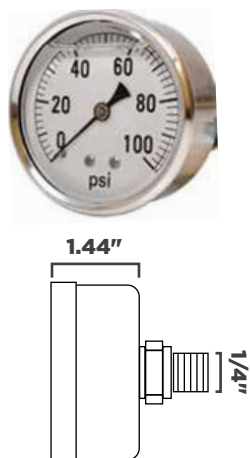

4" REAR MOUNT GLYCERIN GAUGE

PART #	DIAL SIZE	CASE/MOUNT STYLE	FILL MATERIAL	CASE MATERIAL	CONNECTION MATERIAL	PSI
84.940.060	4"	REAR	GLYCERIN	STAINLESS STEEL	STAINLESS STEEL	0 - 60
84.940.100	4"	REAR	GLYCERIN	STAINLESS STEEL	STAINLESS STEEL	0 - 100
84.940.160	4"	REAR	GLYCERIN	STAINLESS STEEL	STAINLESS STEEL	0 - 160
84.940.300	4"	REAR	GLYCERIN	STAINLESS STEEL	STAINLESS STEEL	0 - 300

SERIES 54



4" BOTTOM MOUNT GLYCERIN GAUGE

PART #	DIAL SIZE	CASE/MOUNT STYLE	FILL MATERIAL	CASE MATERIAL	CONNECTION MATERIAL	PSI
84.140.015	4"	BOTTOM	GLYCERIN	STAINLESS STEEL	STAINLESS STEEL	0 - 15
84.140.100	4"	BOTTOM	GLYCERIN	STAINLESS STEEL	STAINLESS STEEL	0 - 100
84.140.160	4"	BOTTOM	GLYCERIN	STAINLESS STEEL	STAINLESS STEEL	0 - 160

SERIES 80

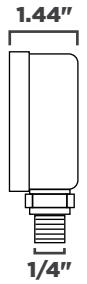

2-1/2" BOTTOM MOUNT DRY GAUGE

PART #	DIAL SIZE	CASE/MOUNT STYLE	FILL MATERIAL	CASE MATERIAL	CONNECTION MATERIAL	PSI
85.825.060	2-1/2"	BOTTOM	DRY	STAINLESS STEEL	304 STAINLESS STEEL	0 - 60
85.825.400	2-1/2"	BOTTOM	DRY	STAINLESS STEEL	304 STAINLESS STEEL	0 - 400

SERIES 80



4" BOTTOM MOUNT DRY GAUGE

PART #	DIAL SIZE	CASE/MOUNT STYLE	FILL MATERIAL	CASE MATERIAL	CONNECTION MATERIAL	PSI
85.804.060	4"	BOTTOM	DRY	STAINLESS STEEL	304 STAINLESS STEEL	0 - 60



MISSING A SIZE, PRESSURE OR STYLE?

**CALL OR E-MAIL FOR SPECIAL ORDER OPTIONS.
MINIMUM ORDER MAY APPLY.**



INLINE SNUBBER

85.140.140



COVERS FOR 2-1/2" FACE

PART#	COLOR
85.300.998	BLACK COVER
85.300.999	BLUE COVER

AMMETER GAUGE

2", 20-0-20

85.354.473



WATER TEMP GAUGE

85.393.476



WATER TEMP GAUGE

3 ZONE

85.393.477



AMMETER GAUGE

2", W/CLAMP

85.410.991



OIL PRESSURE GAUGE

85.419.340



OIL PRESSURE GAUGE

85.439.870



WATER TEMP GAUGE

85.671.350



7 HP & 15 HP POWEREASE ENGINES

POWEREASE



PART #	85.570.070	85.570.150	85.575.150
ENGINE TYPE	AIR-COOLED 4-STROKE OHV	AIR-COOLED 4-STROKE OHV	AIR-COOLED 4-STROKE OHV
DISPLACEMENT	212 CC	420 CC	420 CC
STARTING SYSTEM	RECOIL	RECOIL	ELECTRIC
IGNITION SYSTEM	TRANSISTORIZED MAGNETO	TRANSISTORIZED MAGNETO	TRANSISTORIZED MAGNETO
COMPRESSION RATIO	8.5:1	8.2:1	8.2:1
AMP CHARGE	N/A	N/A	18
FUEL TANK CAPACITY	3.6 LITER	6.7 LITER	6.7 LITER
FUEL	UNLEADED 86 OCTANE OR HIGHER	UNLEADED 86 OCTANE OR HIGHER	UNLEADED 86 OCTANE OR HIGHER
CARBURETOR	HORIZONTAL TYPE BUTTERFLY VALVE	HORIZONTAL TYPE BUTTERFLY VALVE	HORIZONTAL TYPE BUTTERFLY VALVE
LUBRICATION SYSTEM	SPLASH	SPLASH	SPLASH
OIL CAPACITY	0.6 LITER (0.63 U.S. QTS)	1.1 LITER (1.16 U.S. QTS)	1.1 LITER (1.16 U.S. QTS)
LOW OIL SHUTDOWN	YES	YES	YES
SHAFT SIZE	3/4" STRAIGHT KEYED	1" STRAIGHT KEYED	1" STRAIGHT KEYED
KEY WAY SIZE	3/16" X 1-3/4"	1/4" X 2.2"	1/4" X 2.2"
SHAFT ROTATION	COUNTERCLOCKWISE (HORIZONTAL SHAFT OUTPUT)	COUNTERCLOCKWISE (HORIZONTAL SHAFT OUTPUT)	COUNTERCLOCKWISE (HORIZONTAL SHAFT OUTPUT)
NET TORQUE	9.1 LB-FT (12.4 NM) @ 2,500 RPM	17.8 LB-FT (24 NM) @ 2,500 RPM	17.8 LB-FT (24 NM) @ 2,500 RPM
NET POWER OUTPUT	6.03 HP (4.5 KW) @ 3,600 RPM	12.6 HP (9.4 KW) @ 3,600 RPM	12.6 HP (9.4 KW) @ 3,600 RPM
PTO BOLT SIZE	5/16-24 UNF	3/8-24 UNF	3/8-24 UNF
BORE X STROKE	68 MM X 54 MM	88 MM X 64 MM	88 MM X 64 MM
AIR CLEANER	DUAL ELEMENT	DUAL ELEMENT	DUAL ELEMENT
VALVE CLEARANCE	INTAKE: 0.06" OUTTAKE: 0.08"	INTAKE: 0.06" OUTTAKE: 0.08"	INTAKE: 0.06" OUTTAKE: 0.08"
DRY WEIGHT	35 LBS	68 LBS	70 LBS
SHIPPING (LXWXH)	15.15" X 13.38" X 13.38"	16.14" X 17.71" X 17.71"	16.14" X 17.71" X 17.71"

REPLACEMENT PARTS

CARBURETOR ASSEMBLY	85.571.009	85.571.028	85.571.028
AIR CLEANER ASSEMBLY	85.571.010	85.571.029	85.571.029
MUFFLER ASSEMBLY	85.571.011	85.571.030	85.571.030
RECOIL STARTER ASSEMBLY	85.571.006	85.571.026	85.571.026





METAL DUMP CARTS



EASY ASSEMBLY
TAKES 15 MINUTES
OR LESS.



**500 LB CAPACITY
METAL DUMP CART**
TC5010



PART#	CAPACITY	TIRE SIZE	HEAPED LOAD SIZE	LEVEL LOAD SIZE	BODY DIMENSIONS	WEIGHT
TC5010	500 LB	16"	12 FT ³	10 FT ³	40.5" X 32.5" X 11.5"	83.7 LBS

* NOT DESIGNED FOR ROAD USE

**1500 LB CAPACITY
METAL DUMP CART**
TC5014HD



PART#	CAPACITY	TIRE SIZE	HEAPED LOAD SIZE	LEVEL LOAD SIZE	BODY DIMENSIONS	WEIGHT
TC5014HD	1500 LB	18"	17 FT ³	14 FT ³	42" X 30" X 16"	173 LBS

* NOT DESIGNED FOR ROAD USE



POLY DUMP CARTS



HITCH CONNECTION

WORKS GREAT WITH
LAWN & GARDEN TRACTORS,
ATVS & OTHER SMALL
UTILITY VEHICLES



DUMP CARTS

**600 LB CAPACITY
POLY DUMP CART**
TCP600



**1000 LB CAPACITY
POLY DUMP CART**
TCP1000



**1200 LB CAPACITY
POLY DUMP CART**
TCP1200



**1200 LB CAPACITY
POLY DUMP CART**
TCP12004W



**1500 LB CAPACITY
POLY DUMP CART**
TCP1500



**1500 LB CAPACITY
POLY DUMP CART**
TCP15004W



PART#	CAPACITY	TIRE SIZE	HEAPED LOAD SIZE	LEVEL LOAD SIZE	OVERALL DIMENSIONS	BODY DIMENSIONS
TCP600	600 LB	16"	10 FT ³	7 FT ³	65" X 36" X 26"	43.3" X 32.9" X 10.5"
TCP1000	1000 LB	16"	18 FT ³	14 FT ³	83" X 50" X 27"	58.9" X 38.0" X 15.0"
TCP1200	1200 LB	18"	19 FT ³	15 FT ³	85" X 47" X 31"	61.4" X 31.0" X 18.1"
TCP12004W	1200 LB	18"	19 FT ³	15 FT ³	85" X 50" X 31"	61.4" X 31.0" X 18.1"
TCP1500	1500 LB	18"	28 FT ³	22 FT ³	97" X 55" X 31"	69.1" X 39.8" X 17.9"
TCP15004W	1500 LB	18"	28 FT ³	22 FT ³	97" X 58" X 31"	69.1" X 39.8" X 17.9"

* NOT DESIGNED FOR ROAD USE

LAWN AND GARDEN EQUIPMENT

FLAT BALLAST LAWN ROLLERS

81.200.020

AVAILABLE ONLY IN CANADA

- Heavy duty steel roller
- Black hammer tone rust resistant finish

PART#	ROLLER SIZE	LOAD CAPACITY
81.200.020	48 X 14"	379 LB
81.200.021	60 X 14"	467 LB



DRUM SPIKE AERATOR ROLLERS

81.200.040

AVAILABLE ONLY IN CANADA

- Heavy duty steel roller
- Black hammer tone rust resistant finish

PART#	ROLLER SIZE	LOAD CAPACITY
81.200.040	48 X 14"	392 LB
81.200.041	60 X 14"	489 LB



40" TRAIL AERATOR

81.200.004

AVAILABLE ONLY IN CANADA

- 24 Replaceable coring points
- 10" Pneumatic wheels
- Single hand lift lever
- Black hammer tone rust resistant finish
- 81 lbs

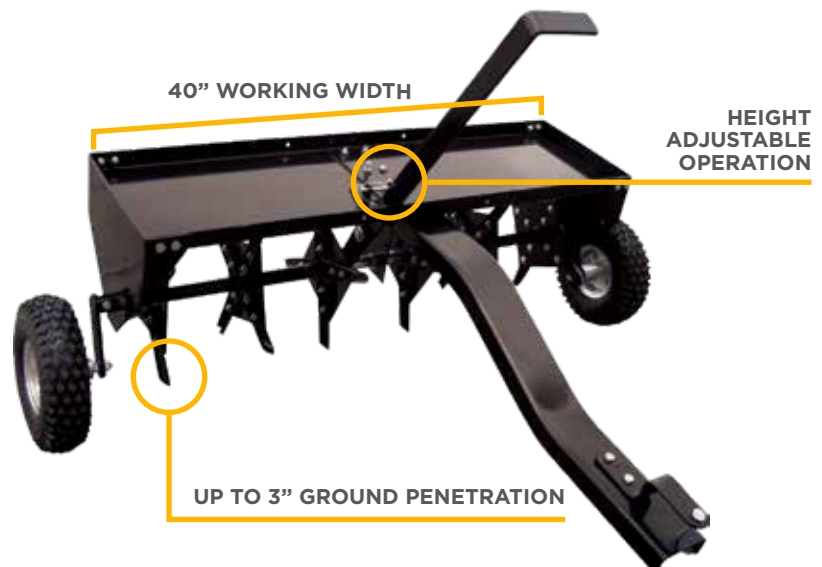

42 IN SWEEPER SW42T

🇨🇦 AVAILABLE ONLY IN CANADA



- Adjustable 10" brushes to accommodate different debris types
- 10-1/2" Rubber wheels
- Black hammer tone rust resistant finish
- 81 lb weight

40" TINE DETHATCHER 81.200.001

🇨🇦 AVAILABLE ONLY IN CANADA

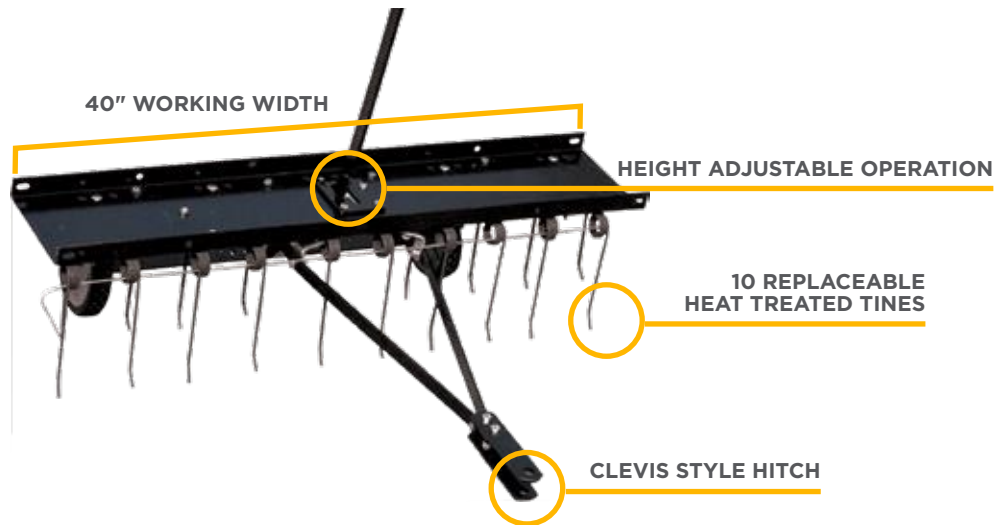

- 20 X 3/16" heat treated teeth
- 7" Rubber tired
- 1/2" Pin hitch type
- Black hammer tone rust resistant finish
- 35 lb weight

HAY BALE UTILITY DOLLY 81.000.001

🇨🇦 AVAILABLE ONLY IN CANADA



HEAVY
DUTY
LARGE
CAPACITY

SPREADERS

**350 LB ATV PULL
FERTILIZER SPREADER**
MFS350T

🇨🇦 AVAILABLE ONLY IN CANADA

***WHILE QUANTITIES LAST**

IDEAL FOR USE WHEN A PTO
IS NOT AVAILABLE

SPREADS SEED, FERTILIZER,
SAND & SALT



STEEL
SQUARE HOPPER

ADJUSTABLE
SPREADING COVERAGE

HEAVY DUTY CAST IRON,
OIL BATH GEARBOX

ADJUSTABLE TOWBAR

14" LARGE
PNEUMATIC TIRES



**250 LB
TOWABLE SPREADER**
PFS105T

🇨🇦 AVAILABLE ONLY IN CANADA

IDEAL FOR USE WHEN A PTO
IS NOT AVAILABLE

SPREADS SEED, FERTILIZER,
SAND & SALT

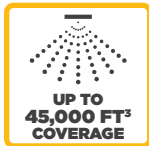

14" LARGE
PNEUMATIC TIRES

INCLUDES
HOPPER COVER

CLEVIS HITCH



**125 LB WALK BEHIND
SPREADER**
PFSS60P

🇨🇦 AVAILABLE ONLY IN CANADA

❄️ IDEAL FOR
WINTER SALT
SPREADING

INCLUDES
SCREEN & RAIN
HOPPER COVER KIT

ERGONOMIC
HANDLES

INTERNAL STAINLESS
STEEL FITTINGS

14" LARGE
PNEUMATIC TIRES



DIAMOND HARROW
HAR40S - 40"

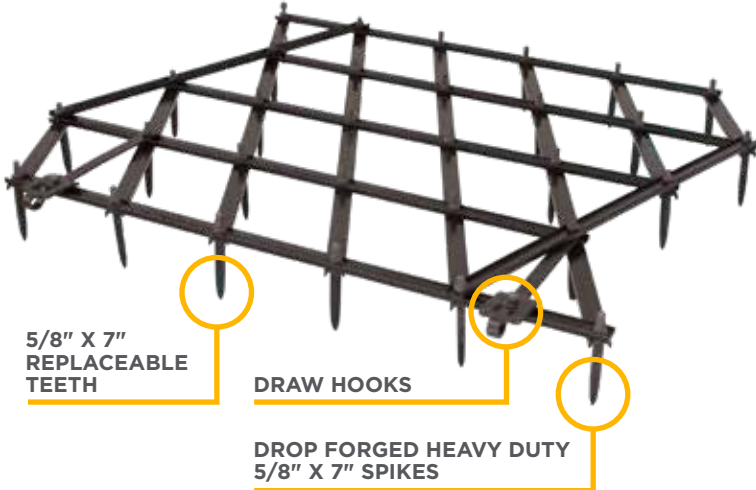

5/8" X 7"
REPLACEABLE
TEETH

DRAW HOOKS

DROP FORGED HEAVY DUTY
5/8" X 7" SPIKES

PART#	HAR40S	HAR60S
WEIGHT	62 LBS	98 LBS
WORKING WIDTH	40"	60"
LENGTH	52"	52"

REPLACEMENT WEAR PARTS

DRAW HOOK	61.200.010	61.200.010
TINES	61.200.002	61.200.002

57" X 36" DRAG HARROW
81.200.060

🇨🇦 AVAILABLE ONLY IN CANADA

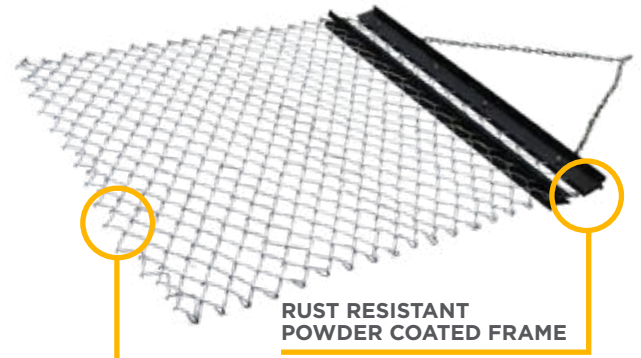

RUST RESISTANT
GALVANIZED MESH

RUST RESISTANT
POWDER COATED FRAME

- Rust resistant galvanized mesh
- Rust resistant powder coated frame
- Ideal for leveling or smoothing dirt & gravel or seeding lawns
- Attaches easily to vehicles
- 44 lbs

ATV GRADER BLADE
BE-GBA5G

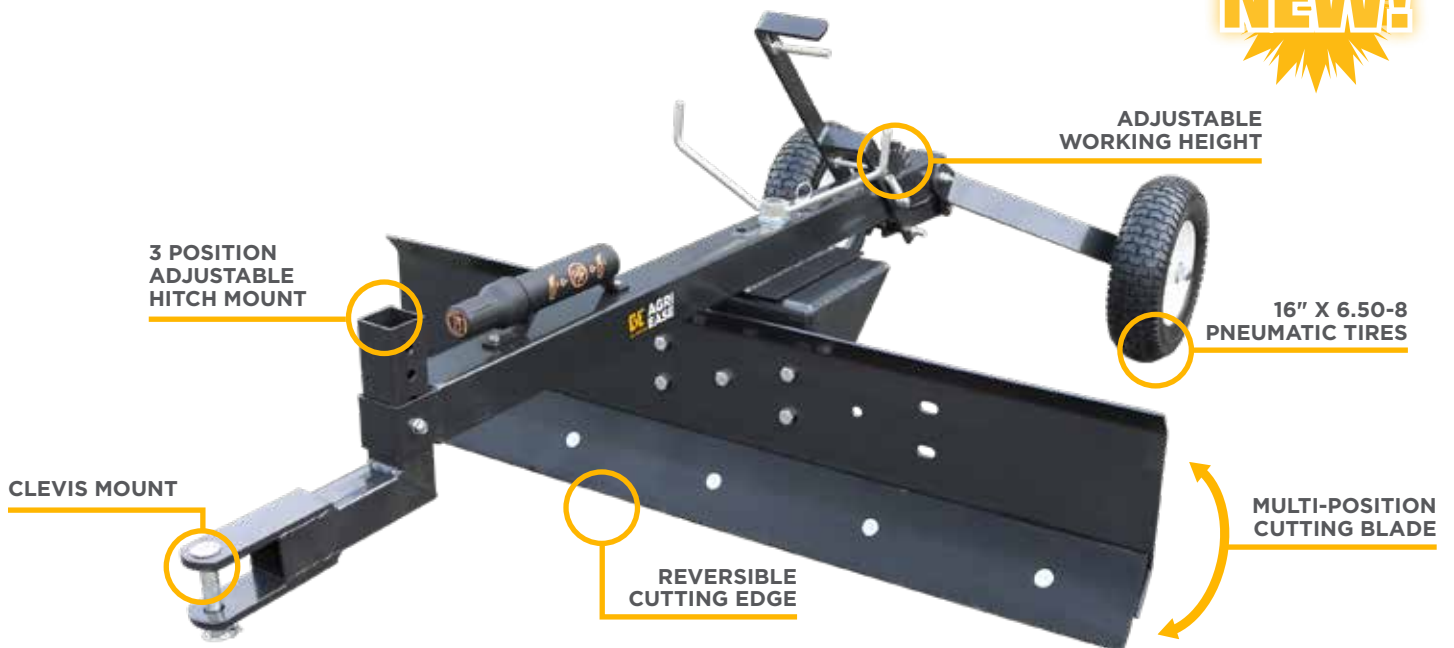

3 POSITION
ADJUSTABLE
HITCH MOUNT

ADJUSTABLE
WORKING HEIGHT

16" X 6.50-8
PNEUMATIC TIRES

CLEVIS MOUNT

REVERSIBLE
CUTTING EDGE

MULTI-POSITION
CUTTING BLADE

TRACTOR BUCKET ATTACHMENTS

SKID STEER WELD-ON ADAPTOR PLATE
ABSS



PART#	ABSS
HEIGHT	18-7/8"
WIDTH	47-1/4"
DEPTH	3-1/8"

BUCKET MOUNT RECEIVER
64.500.342



NEW FOOTPAD DESIGN FOR EXTRA STABILITY

2" SQUARE RECEIVER



EURO WELD-ON MOUNT (PAIR)
WOKAO600



WOKAO600



JDBFSET

PART#	DESCRIPTION	WEIGHT
WOKAO600	EURO ATTACHMENT	36 LBS
JDBFSET	JD WELD-ON	33 LBS

SOLID FORGED 3/8" BUCKET HOOK SET
BOLT-ON / WELD-ON
64.500.700

NEW!



PART#	SIZE	GRADE	WLL
64.500.700*	3/8"	G70	6600 LB
64.500.701**	3/8"	G70	6600 LB

* RETAIL FRIENDLY BLISTER PACK

** BULK CARTON PACKAGING

WELD-ON BUCKET HOOK
64.500.038



PART#	SIZE	GRADE	WLL
64.500.516	5/16"	G70	4700 LB
64.500.038	3/8"	G70	6600 LB
64.500.076	7/16"	G70	8800 LB
64.500.012	1/2"	G70	11300 LB

BUCKET ACCESSORY PLATES
64.500.705

NEW!



64.500.705



64.500.705G

GRADE 8 HARDWARE INCLUDED



PART#	HOOK SIZE	GRADE	WLL	D RINGS	RECEIVER SIZE	HITCH PIN HOLE SIZE	MOUNT	PLATE DIMENSIONS
64.500.705	5/16"	G70	4700 LB	1/2"	2"	5/8"	UNIVERSAL	22" X 4-3/8" X 1/4"
64.500.705G*	5/16"	G70	4700 LB	1/2"	2"	5/8"	JOHN DEERE	22" X 6" X 1/4"

* 64.500.705G FITS JOHN DEERE STYLE BUCKETS: 53", 57", 57"HD, 61", & 73"

PALLET FORKS

CLAMP-ON PALLET FORKS WITH STABILIZER BAR BFT1002N



BFT1002N PICTURED

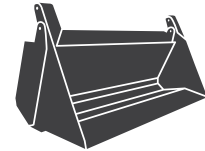

COMPATIBLE WITH BUCKETS!



PART #	CAPACITY	WEIGHT	TOTAL LENGTH	FORK LENGTH	FORK WIDTH	FORK THICKNESS
BFT1002N	1000 LBS	115 LBS	45-3/4"	32"	3-1/4"	2"
BFT2002N	2000 LBS	183 LBS	64"	44"	4"	2"

REPLACEMENT CLAMP-ON PALLET FORK BFT1000G

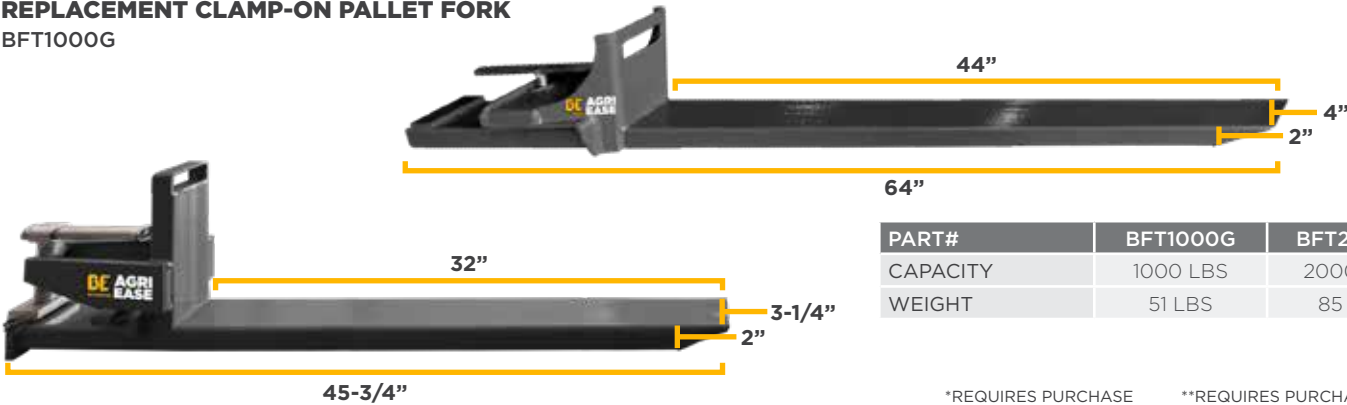

PART#	BFT1000G	BFT2000N
CAPACITY	1000 LBS	2000 LBS
WEIGHT	51 LBS	85 LBS

*REQUIRES PURCHASE OF 18+ UNITS

**REQUIRES PURCHASE OF 16+ UNITS

FORK EXTENSION 2 METERS, 6.6', 110 LB EXT3T2M



OSHA REQUIRES FORK EXTENSION LENGTH TO BE NO LONGER THAN 150% OF THE LENGTH OF THE SUPPORT FORKS

ADJUSTABLE PALLET FORK STABILIZER BAR BFT10GSTAB



PART #	MIN LENGTH	MAX LENGTH	# OF ADJ. POSITIONS
BFT10GSTAB	20-3/4"	38-1/4"	9
BFT20GSTAB			

36" REPLACEMENT FORK

PFT36LDJ - 36"



CLASS II LOCKING FORKS

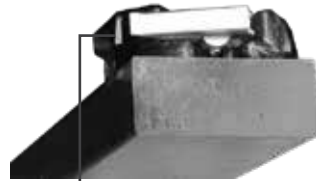

REPLACEABLE STAINLESS LATCH

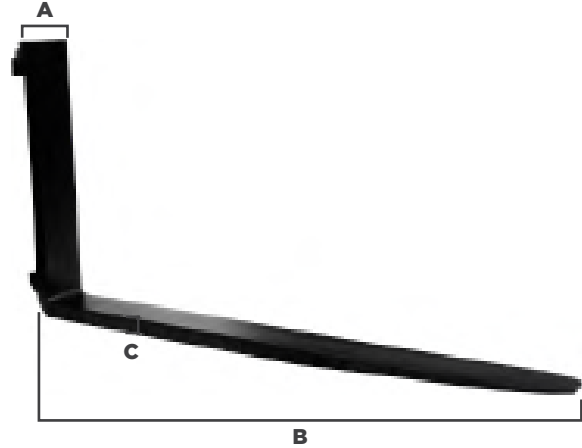

PALLET FORK TINES

PART#	PFT36ELD	PFT36LDJ	PFT42LDJ	PFT42HDJ	PFT48HDJ	PFT48HDJ5500
MOUNT	CLASS II A	CLASS II A	CLASS II A	CLASS II A	CLASS II A	CLASS II A
WEIGHT	45 LBS	75 LBS	85 LBS	101 LBS	112 LBS	130 LBS
CAPACITY (PER PAIR)	1100 LBS	2200 LBS	3700 LBS	4400 LBS	4400 LBS	5500 LBS
A	4"	4"	4"	4"	4"	4-3/4"
B	36"	36"	42"	42"	48"	48"
C	1.25"	1.25"	1.25"	1.5625"	1.5625"	1.5625"

3 POINT BIN & PALLET FORK

ABFG



PALLET & BIN FORK

PART#	ABFG	ABFHDG
CAPACITY	1200 LBS	2000 LBS
HITCH	CATEGORY 1, 3 POINT	CATEGORY 1, 3 POINT
SIZE	L41" X 25" CENTER	L41" X 25" CENTER
FORK SIZE	2" X 4" TUBE	1-1/4" X 4" SOLID
WEIGHT	90 LBS	174 LBS

WIDE PALLET JACK

27" X 48"

B27002

- Capacity: 5500 lb
- Overall height: 64"
- Fork length: 48"
- Overall fork width: 27"
- Weight: 154 lb
- Lowered fork height: 2.95"
- Max lifting height: 7.28"
- Ground clearance: 0.87"
- Turning radius: 53"
- Service weight: 154.32 lb



NARROW PALLET JACK

21-1/2" X 48"

B27001

- Capacity: 5500 lb
- Overall height: 64"
- Fork length: 48"
- Overall fork width: 21.5"
- Weight: 143 lb
- Lowered fork height: 2.95"
- Max lifting height: 7.28"
- Ground clearance: 0.87"
- Turning radius: 53"
- Service weight: 143.3 lb



TRUE CATEGORY 1 QUICK HITCH

QH1N



NO BUSHING ADAPTER
KIT REQUIRED

CATEGORY 1 QUICK HITCH

QH1GI

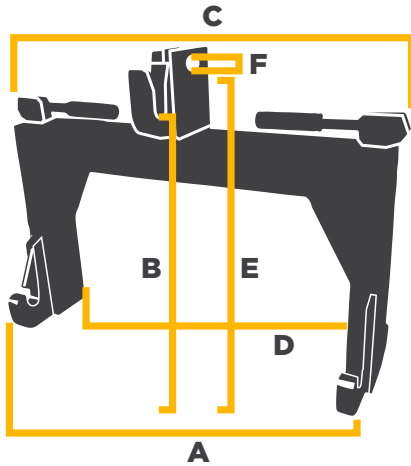

SUB COMPACT 3 POINT QUICK HITCH

QH1SC



CATEGORY 2 HEAVY DUTY QUICK HITCH

QH2HDG



CATEGORY 2-3 QUICK HITCH

QH2-3G



CATEGORY 3-1 QUICK HITCH BUSHING KIT

QK1-B

CATEGORY 3-2 QUICK HITCH BUSHING KIT

QK2-B



PART #	QH1SC	QH1N*	QH1GI**	QH2G	QH2HDG	QH2-3G	QH3NG	QH3G
WEIGHT	37 LBS	72 LBS	72 LBS	139 LBS	163 LBS	197 LBS	176 LBS	184 LBS
WIDTH	32-1/4"	29"	29"	36"	36"	42"	37"	42"
MAX HP RATING	25 HP	50 HP	50 HP	100 HP	130 HP	225 HP	225 HP	225 HP
HITCH	CAT 1	CAT 1	CAT 1	CAT 2	CAT 2	CAT 2-3	CAT 3 NARROW	CAT 3
A	32"	27"	27"	32-3/4"	33"	38"	33-1/2"	38-1/2"
B	14-7/8"	17"/20"	17"/20"	18"	17-1/2"	21-3/4"	21-1/4"	21-3/4"
C	32"	30-1/4"	30-1/4"	37-1/2"	38-1/2"	43-1/2"	38"	43-1/2"
D	24-1/2"	26-1/2"	26-1/2"	36-3/4"	37-1/2"	36-1/2" / 42-1/2"	37"	42-1/2"
E	20-1/4"	20-1/4"	20-1/4"	21"	23-1/4"	26-3/4"	27-1/4"	27"
F	1"	1"	1"	1"	1"	1-3/4"	1-3/4"	1-3/4"

* QH1N INCLUDES TRUE CATEGORY 1 LIFT ARM HOOKS AND DOES NOT REQUIRE AN ADAPTER BUSHING KIT

** QH1GI INCLUDES ADAPTER BUSHING KIT PART # QK1-B

3 POINT TRACTOR ATTACHMENTS

HILLER/MIDDLEBUSTER MB15N



1/2" X 2-1/2" X 15"
REVERSIBLE
SHOVEL



PART #	MB15N
HP RATING	UP TO 40 HP
WEIGHT	110 LBS
FURROWER	15"

REPLACEMENT WEAR PARTS

PART #	MB15N
POINT	MB01G

SUBSOILER SS1RN

BOXED

EACH



PART #	SS1RN
DEPTH	22"
HP RATING	UP TO 40 HP
WEIGHT	98 LBS

REPLACEMENT WEAR PARTS

PART #	SS1RN
POINT	SSPOINTG

REAR WEIGHT BOX 3.67 FT³ / 550 LB CAPACITY BE-RWB1



NEW!

CAT 1,
QUICK HITCH COMPATIBLE

2 SLEEVES
FOR HOLDING
COMMON TOOLS

INCLUDES LIFT ARM PINS
& TOP LINK PIN

SLIDING DOOR
FOR EASY ACCESS
TO INTERIOR

2" SQUARE RECEIVER
WITH 5/8" HOLE



FILL GUIDE

FILL TYPE	WEIGHT PER FT ³
CONCRETE	150 LBS
GRAVEL	110 LBS
SAND	100 LBS

PART #	BE-RWB1
HITCH	CAT 1
BOX VOLUME	3.67 FT ³
CAPACITY (WITH BOX)	575 LBS
CAPACITY (FILL ONLY)	550 LBS
QUICK HITCH COMPATIBLE	YES
SHIPPING WEIGHT	104 LBS
OVERALL DIMENSIONS	26-1/8" X 13-7/8" X 28-3/4"

BOOM POLE 72" 64.500.339



**MINOR
ASSEMBLY**

PART #	64.500.339
HITCH	CAT 1
WEIGHT	52 LBS
CAPACITY	600 LBS
LENGTH	75"
WIDTH	33"
HEIGHT	20"

3 POINT TRACTOR ATTACHMENTS

TRAILER RECEIVER WITH TRIPLE BALL CAT 1, TOW HITCH LOWER CONNECTION
64.500.340B



TRAILER RECEIVER WITH TRIPLE BALL CAT 1, TOW HITCH UPPER & LOWER CONNECTION
64.500.341B



TRAILER RECEIVER WITH TRIPLE BALL CAT II, HD UPPER & LOWER CONNECTION
64.500.343B



3 POINT HITCH TRAILER RECEIVER CATEGORY 1 LOWER CONNECTION
64.500.340Q



3 POINT HITCH TRAILER RECEIVER CATEGORY 1 UPPER & LOWER CONNECTION
64.500.341Q



3 POINT HITCH TRAILER RECEIVER CATEGORY 2, HD UPPER & LOWER CONNECTION
64.500.343Q



3 POINT TRAILER MOVER CATEGORY 1 UPPER BALL MOUNT LOWER RECEIVER
64.500.344



POPULAR 2" MOUNTS (SOLD SEPARATELY)

*FIND OUR FULL SELECTION OF MOUNTS ON PAGE 135



64.500.330
CLEVIS STYLE MOUNT



64.500.320
2" DROP TRAILER BALL MOUNT



64.500.321
4" DROP TRAILER BALL MOUNT



64.500.326
CHROME TRIPLE TOW BALL WITH TOW HOOK



64.500.026
CHROME TRIPLE TOW BALL WITH CLEVIS CHANNEL

BALL MOUNTS & ACCESSORIES

BALL MOUNTS - 2" SHAFT

PART#	FINISH	CLASS	TW (LB)	GTW (LB)	HOLE SIZE	DROP
64.500.323	BLACK	3	500	5000	1"	STRAIGHT
64.500.320	BLACK	4	600	6000	1"	2"
64.500.321	BLACK	4	600	6000	1"	4"
64.500.332	BLACK	4	600	6000	1"	6"

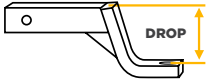

BALL MOUNT KIT - 2" SHAFT

PART#	FINISH	CLASS	BALL SIZE	TW (LB)	GTW (LB)	HOLE SIZE	DROP
64.500.029	BLACK	4	2"	600	6000	1"	2"



DOUBLE BALL MOUNT - WELDED - 2" HOLLOW SHAFT

PART#	FINISH	CLASS	BALL SIZE	TW (LB)	GTW (LB)	DROP
64.500.022	BLACK	3-4	1-7/8" 2"	350 600	3500 6000	2" 3/4" RISE



TRIPLE BALL MOUNT - WELDED - 2" SOLID SHAFT

PART#	FINISH	CLASS	BALL SIZE	TW (LB)	GTW (LB)	DROP
64.500.025	BLACK	3-4	1-7/8" 2" 2-5/16"	350 600 1000	3500 6000 10000	STRAIGHT



TRIPLE BALL MOUNT WITH TOW HOOK - WELDED - 2" SOLID SHAFT

PART#	FINISH	CLASS	BALL SIZE	TW (LB)	GTW (LB)	DROP
64.500.326	CHROME	3-4	1-7/8" 2" 2-5/16"	350 600 1000	3500 6000 10000	STRAIGHT



TRIPLE BALL MOUNT WITH CLEVIS HITCH - WELDED - 2" SOLID SHAFT

PART#	FINISH	CLASS	BALL SIZE	TW (LB)	GTW (LB)	DROP
64.500.026	CHROME	3-4	1-7/8" 2" 2-5/16"	350 600 1000	3500 6000 10000	STRAIGHT



CLEVIS BALL MOUNT - 2" SHAFT

PART#	FINISH	TW (LB)	GTW (LB)	TUBE	HOLE
64.500.330	BLACK	600	6000	STRAIGHT	1"



HITCH ADAPTER

PART#	FINISH	DESCRIPTION	GTW (LB)
64.500.108	BLACK	CONVERTS 1-1/4" TO 2" RECEIVER	3500



PINTLE MOUNT

PART#	FINISH	PLATE SIZE	TW (LB)	GTW (LB)	# OF HOLES
64.500.010	BLACK	5-1/2" X 5"	1000	10000	6



PINTLE HOOK

PART#	FINISH	CAPACITY	TW (LB)	GTW (LB)	# OF HOLES
64.500.801	BLACK	15 TON	6000	30000	4



4 HOLE MOUNTING LUNETTE RING

FORGED STEEL WITH BLACK POWDER COATED FINISH

PART#	DESCRIPTION	TOW RATING
64.500.804	2-1/2" DIAMETER RING WITH SQUARE 6" BASE PLATE, 5/8" DIAMETER MOUNTING HOLES, 4000 LB. VERTICAL LOAD	42000 LB



STEP BUMPER RECEIVER

PART#	FINISH	PLATE SIZE	TW (LB)	GTW (LB)	# OF HOLES	HOLE SPACING (C-C)
64.500.106	BLACK	13-3/4" X 4-3/4"	500	5000	4 (ADJUSTABLE)	OUTER 11-5/8" INNER 7-3/4"



HITCH MOUNT FOLDING CARGO CARRIER - 2" SHAFT

PART#	FINISH	BASKET DIMENSIONS	CAPACITY
64.500.231	BLACK	61" X 19" X 6"	500 LB (226 KG)



CLAMP-ON BUCKET MOUNT RECEIVER

PART#	FINISH	RECEIVER SIZE	FIT
64.500.342	RED	2"	UNIVERSAL



TRAILER DOLLY

PART#	FINISH	TRAILER BALL	CAPACITY	WHEELS
81.200.600	BLACK	2" (REMOVABLE)	600 LB	10"

AVAILABLE ONLY IN CANADA



HITCH PINS & CLIPS

LOCKABLE HITCH PIN

5/8" X 3 1/2"

64.500.258

- HD solid steel construction
- Chrome plated finish
- Weather resistant dust cap
- Easy 1/4 turn operation
- Includes 2 keys



BENT HITCH PINS - YELLOW ZINC DI-CHROMATE PLATED

PART#	DIAMETER	USABLE LENGTH	HAIR PIN
725HP	5/16"	3"	P-7923B12
723HP	3/8"	3"	P-7923B12
720HPS	1/2"	2-1/2"	P-7924B8
720HP	1/2"	3"	P-7924B8
720HPL	1/2"	4"	P-7924B8
720HPXL	1/2"	5"	P-7924B8
722HP	5/8"	3"	P-7924B8
722HPL	5/8"	3-1/2"	P-7924B8
722HPEL	5/8"	4"	P-7924B8
722HPXL	5/8"	5"	P-7924B8
721HP	3/4"	3-1/2"	P-7924B8
721HPXL	3/4"	4-1/2"	P-7924B8



2-1/2 MM X 43 MM HAIR PINS

12 PIECE BAG

P-7923B12



3 MM X 64 MM HAIR PINS

8 PIECE BAG

P-7924B8



TRAILER BALLS

EXTERNAL THREAD TRAILER BALLS

PART#	DIAMETER	THREAD DIAMETER	THREAD LENGTH	GROSS LOAD RATING
64.500.348	1-7/8"	3/4"	1-1/2"	2000 LB
64.500.345	1-7/8"	1"	2-5/8"	3500 LB
64.500.349	2"	3/4"	2"	3500 LB
64.500.350	2"	1"	2"	5000 LB
64.500.358	2"	1-1/4"	2-1/4"	8000 LB
64.500.351	2-5/16"	1"	2-5/8"	5000 LB
64.500.352	2-5/16"	1-1/4"	2-1/4"	7500 LB
64.500.353	2-5/16"	1-1/4"	2-1/4"	10000 LB
64.500.354	2-5/16"	1-1/4"	2-1/4"	12000 LB



LONG EXTERNAL THREAD TRAILER BALLS

PART#	DIAMETER	THREAD DIAMETER	THREAD LENGTH	GROSS LOAD RATING
64.500.355	1-7/8"	3/4"	3-1/4"	2000 LB
64.500.356	2"	3/4"	3-1/4"	3500 LB
64.500.357	2"	1"	3-1/4"	5000 LB



INTERNAL THREAD TRAILER BALLS

PART#	DIAMETER	THREAD DIAMETER	THREAD LENGTH	GROSS LOAD RATING
64.500.346	1-7/8"	3/4"	2"	2000 LB
64.500.347	2"	3/4"	2"	3500 LB



CHANNEL TRAILER COUPLERS

PART#	FINISH	CLASS	BALL DIAMETER	CHANNEL SIZE	GROSS LOAD RATING
64.500.003	ZINC	1	1-7/8"	2"	2000 LB
64.500.007	ZINC	1	1-7/8"	2-1/2"	2000 LB
64.500.008	ZINC	1	1-7/8"	3"	2000 LB
64.500.004	ZINC	2	2"	2"	3500 LB
64.500.005	ZINC	2	2"	2-1/2"	3500 LB
64.500.006	ZINC	2	2"	3"	3500 LB



A-FRAME TRAILER COUPLERS

PART#	FINISH	CLASS	BALL DIAMETER	MAX TONGUE WEIGHT	GROSS LOAD RATING
64.800.726	ZINC	3	2"	700 LB	5000 LB
64.500.100	BLACK	3	2"	700 LB	5000 LB
64.819.117	ZINC	4	2-5/16"	1500 LB	10000 LB



UNIVERSAL TRAILER COUPLER LOCK

64.500.906



- Universal design fits most couplers
- Dual ratchet locking system
- Protected by durable hammer-tone epoxy finish
- Locking bar includes 6 locking positions

BRASS TRAILER COUPLER LOCK

64.500.908



- Easy 1/4 turn operation
- Hardened steel locking pin
- Solid brass construction
- Includes 2 keys

MEDIUM DUTY SAFETY CHAINS

PART#	FINISH	CHAIN GRADE	CHAIN SIZE	CHAIN LENGTH	SECURING END
64.325.024	ZINC PLATED ELECTRO-GALVANIZED	G43	1/4"	24"	S-HOOK W/LATCH
64.325.030	ZINC PLATED ELECTRO-GALVANIZED	G30	1/4"	30"	S-HOOK W/LATCH



HEAVY DUTY SAFETY CHAINS

PART#	FINISH	CHAIN GRADE	CHAIN SIZE	CHAIN LENGTH	SECURING END
64.303.516	ZINC PLATED ELECTRO-GALVANIZED	G43	5/16"	36"	SLIP HOOK W/ SAFETY LATCH
64.304.516	ZINC PLATED ELECTRO-GALVANIZED	G70	5/16"	36"	SLIP HOOK W/ SAFETY LATCH
64.304.038	ZINC PLATED ELECTRO-GALVANIZED	G70	3/8"	36"	SLIP HOOK W/ SAFETY LATCH



64.303.516



64.304.516

12V LED TOWING LIGHTS

LT1230

- 24 LEDs (12 on each side)
- 30 ft wiring harness included
- Magnetic base
- 100,000 hours life time



- Mounts easily to any vehicle
- Stop / tail / turn functions
- Scratch resistant magnetic base
- 22 lb magnetic pull
- Ideal for up to 80" wide applications
- 4-1/2" Acrylic lenses
- 12 Super bright LEDs per light
- 30' wiring harness with 4-pin flat connectors
- DOT certified

12V COMMERCIAL GRADE LED TOWING LIGHTS

LTHD1230

- Carrying case included
- 30 ft wiring harness included
- 7 ft span between two lights
- 60 lb round pull magnets



- Mounts easily to any vehicle
- Stop / tail / turn functions
- Scratch resistant magnetic base
- 70 lb magnetic pull
- Ideal for up to 84" wide applications
- 4" Acrylic lenses with polycarbonate housings
- 12 Super bright LEDs per light
- 30' heavy duty wiring harness with 4 pin round connectors
- DOT certified
- Storage / carry case included

12V SUBMERSIBLE LED TRAILER LIGHT KIT

LST1222



- For trailers up to 80" wide
- 22 ft wiring harness included
- Mounting hardware & license plate bracket
- DOT certified

- Easy installation with included license plated bracket and hardware
- Stop / tail / turn functions with built in license plate light
- Ideal for up to 80" wide applications
- Great for boat, camper, utility and snowmobile trailers
- 4" Acrylic lenses with ABS housings
- Lens & housings are sonically sealed w/ epoxy sealed electronics
- 12 Super bright LEDs per light
- 22' wiring harness with 4 pin flat connectors
- DOT certified

HAND WINCHES

PART#	DESCRIPTION	LOAD CAPACITY	GEAR RATIO
64.500.253	1 SPEED	1400 LB	4:01
64.500.254	2 SPEED	2000 LB	4:1 / 10:1



HAND WINCH WITH NYLON STRAP

PART#	DESCRIPTION	LOAD CAPACITY	GEAR RATIO	STRAP LENGTH
64.500.200	1 SPEED - NYLON STRAP	1600 LB	5.1:1	20'



HAND WINCH WITH BRAIDED CABLE

PART#	DESCRIPTION	LOAD CAPACITY	GEAR RATIO	CABLE LENGTH
64.500.800	1 SPEED - BRAIDED STEEL CABLE	1000 LB	4.1:1	10'
64.500.250	2 SPEED -BRAIDED STEEL CABLE	2500 LB	5.1:1 / 12.1:1	10'



RATCHETING CABLE POWER PULLER HAND WINCH

PART#	DESCRIPTION	SAFE WORKING CAPACITY	MAX RATED CAPACITY	CABLE DIAMETER	CABLE LENGTH
64.500.222	2 TON - HD AIRCRAFT CABLE	1 TON (2000 LB)	2 TON (4000 LB)	3/16"	12'

- Constructed from heavy gauge flat stock steel
- Heavy duty ratchet and pawl are constructed from three separate
- Plates of steel paired with hd drop forged safety latch hooks
- 12 Feet of heavy duty 3/16" aircraft cable

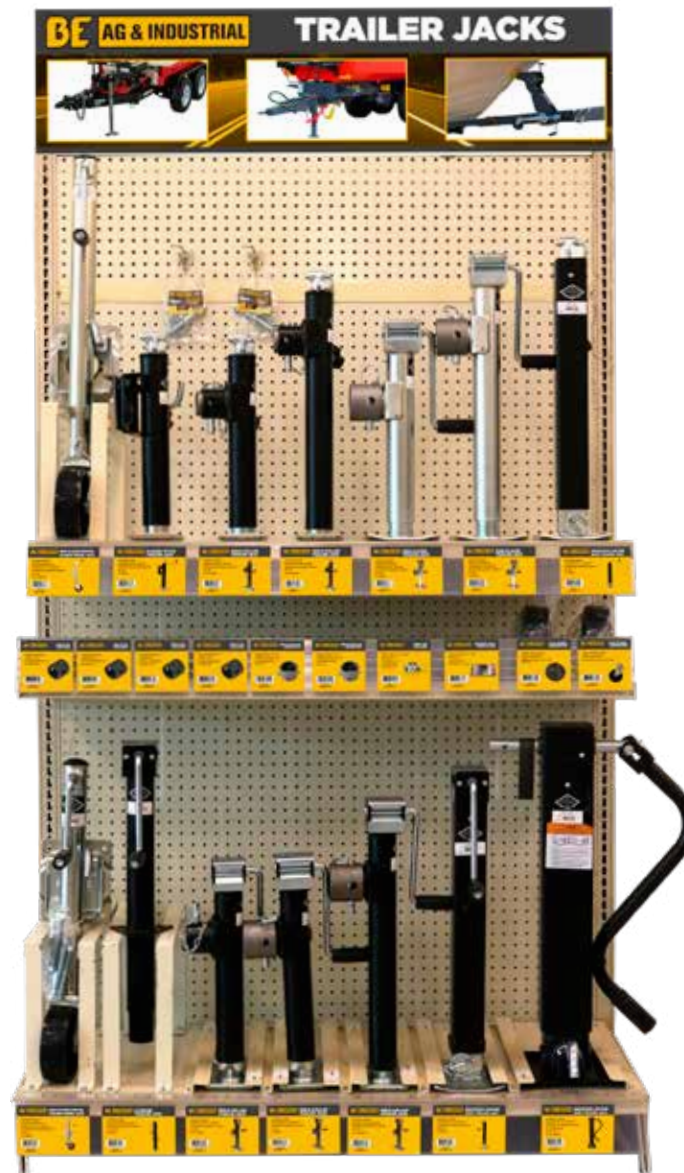

BE AG & INDUSTRIAL**TRAILER JACK PLAN-O-GRAM****PLAN-O-GRAM CONSISTS OF:**

- 1 HEADER SIGN
- 2 SIGN CLIPS
- 3 PLASTIC SIGN HOLDERS, 4'
- 24 POINT OF PURCHASE CARDS
- 6 JACK TOWERS
- 22 JACK RAILS
- 56 BOLT, HEX 1/4 X 1/2" NC
- 56 FLAT WASHER, 1/4"
- 56 NUT, HEX 1/4"

**DESIGNED TO WORK WITH
STANDARD LOZIER SHELVING UNITS****INFORMATIVE POP MATERIAL
SIMPLIFIES AND MAKES
PROGRAM CONSUMER FRIENDLY**

**CONTACT US TODAY FOR INFORMATION AND PRICING ON OUR TRAILER JACK PROGRAM.
RECEIVE THE MERCHANDISERS FREE WITH THE PURCHASE OF THE COMPLETE PROGRAM.**

3500 LB ELECTRIC TRAILER JACK - 12V DC BE-800-EL



- This heavy duty steel trailer jack easily raises, lowers or levels up to 3500 lbs with the push of a button.
- Fits a-frame trailer couplers
- 8-1/2" To 31-1/2" height range
- 7-1/8" Diameter foot plate
- Includes handle for manual cranking
- Black powder coated finish for superior rust and corrosion resistance
- 12v DC electrical type

WELD COLLAR TRAILER JACKS

PART#	HANDLE TYPE	MAX LIFT CAPACITY	MAX SUPPORT CAPACITY	LIFT	HEIGHT
BE-020	TOPWIND	2000 LB	2600 LB	10"	11-1/4"
BE-020X	TOPWIND	2000 LB	2600 LB	10"	11-1/4"
BE-520	TOPWIND	2000 LB	2600 LB	15"	15-1/2"
BE-1050	TOPWIND	5000 LB	6000 LB	10"	10-1/2"

WELD COLLAR TRAILER JACKS

PART#	HANDLE TYPE	MAX LIFT CAPACITY	MAX SUPPORT CAPACITY	LIFT	HEIGHT
BE-1020S	SIDEWIND	2000 LB	2600 LB	10"	11-1/4"
BE-050	SIDEWIND	5000 LB	6000 LB	10"	11"
BE-550	SIDEWIND	5000 LB	6000 LB	15"	15-1/2"



A-FRAME TRAILER JACKS

PART#	HANDLE TYPE	MAX LIFT CAPACITY	MAX SUPPORT CAPACITY	LIFT	HEIGHT
BE-120	TOPWIND	2000 LB	2600 LB	13-1/2"	7"
BE-140	TOPWIND	5000 LB	6000 LB	13-1/2"	7"



A-FRAME TRAILER JACKS

PART#	HANDLE TYPE	MAX LIFT CAPACITY	MAX SUPPORT CAPACITY	LIFT	HEIGHT
BE-130	SIDEWIND	2000 LB	2600 LB	13-1/2"	7"



FLANGE STYLE TRAILER JACKS

PART#	HANDLE TYPE	MAX LIFT CAPACITY	MAX SUPPORT CAPACITY	LIFT	HEIGHT
FJ-020	TOPWIND	2000 LB	2600 LB	10"	11"
FJ-530	TOPWIND	2000 LB	2600 LB	15"	15"



FLANGE STYLE TRAILER JACKS

PART#	HANDLE TYPE	MAX LIFT CAPACITY	MAX SUPPORT CAPACITY	LIFT	HEIGHT
FJ-540	SIDEWIND	2000 LB	2600 LB	15"	15"



SPECIALTY TRAILER JACKS

PART#	FEATURE	HANDLE TYPE	MAX LIFT CAPACITY	MAX SUPPORT CAPACITY	LIFT
BE-1010S	TAILGATE / NO BASE	SIDEWIND (REMOVABLE)	2000 LB	2600 LB	10"



SPECIALTY TRAILER JACKS

PART#	FEATURE	HANDLE TYPE	MAX LIFT CAPACITY	MAX SUPPORT CAPACITY	LIFT
BE-1520S	NO MOUNT TUBE	SIDEWIND	2000 LB	2600 LB	15"



ZINC PLATED TRAILER JACKS

PART#	HANDLE TYPE	MOUNT TYPE	MAX LIFT CAPACITY	MAX SUPPORT CAPACITY	LIFT
BE-5015	SIDEWIND	BOLT ON PLATE	5000 LB	6000 LB	15"



ZINC PLATED TRAILER JACKS

PART#	HANDLE TYPE	MOUNT TYPE	MAX LIFT CAPACITY	MAX SUPPORT CAPACITY	LIFT	HEIGHT
ST-2104	TOPWIND	WELD COLLAR	2000 LB	2600 LB	10"	11"
ST-2154	TOPWIND	WELD COLLAR	2000 LB	2600 LB	15"	16"
BE-555	TOPWIND	WELD COLLAR	5000 LB	6000 LB	15"	15-1/2"



ZINC PLATED TRAILER JACKS

PART#	HANDLE TYPE	MOUNT TYPE	MAX LIFT CAPACITY	MAX SUPPORT CAPACITY	LIFT	HEIGHT
LT-5103	SIDEWIND	WELD COLLAR	7000 LB	8000 LB	10"	11"
LT-5153	SIDEWIND	WELD COLLAR	7000 LB	8000 LB	15"	16"



ZINC PLATED SWIVEL FLANGE WHEEL JACKS

PART#	HANDLE TYPE	CASTER WHEEL	MAX LIFT CAPACITY	MAX SUPPORT CAPACITY	LIFT	HEIGHT
TJ-06-01K	SIDEWIND	POLY 6"	1200 LB	1600 LB	10"	14"
TJ-07-51L	SIDEWIND	POLY 6"	1000 LB	1000 LB	15"	12-1/2"



ZINC PLATED SWIVEL FLANGE WHEEL JACKS

PART#	HANDLE TYPE	CASTER WHEEL	MAX LIFT CAPACITY	MAX SUPPORT CAPACITY	LIFT	HEIGHT
TJ-06-02K	SIDEWIND	DUAL 6"	1500 LB	2000 LB	10"	14"



ZINC PLATED SWIVEL FLANGE WHEEL JACKS

PART#	HANDLE TYPE	CASTER WHEEL	MAX LIFT CAPACITY	MAX SUPPORT CAPACITY	LIFT	HEIGHT
TJ-06-06K	SIDEWIND	POLY 8"	1500 LB	2000 LB	10"	14"



ZINC PLATED SWIVEL FLANGE WHEEL JACKS

PART#	HANDLE TYPE	CASTER WHEEL	MAX LIFT CAPACITY	MAX SUPPORT CAPACITY	LIFT	HEIGHT
TJ-01-405	SIDEWIND	POLY 6"	1000 LB	1000 LB	14"	8-1/2" - 23"

INDUSTRIAL SQUARE BODY TRAILER JACKS

PART#	HANDLE TYPE	MAX LIFT CAPACITY	MAX SUPPORT CAPACITY	LIFT	HEIGHT
BE-500	SIDEWIND	3000 LB	5000 LB	15"	15"

INDUSTRIAL SQUARE BODY TRAILER JACKS

PART#	HANDLE TYPE	MAX LIFT CAPACITY	MAX SUPPORT CAPACITY	DROP LEG	LIFT
BE-720	TOPWIND	7000 LB	8000 LB	13"	15"

INDUSTRIAL SQUARE BODY TRAILER JACKS

PART#	HANDLE TYPE	MAX LIFT CAPACITY	MAX SUPPORT CAPACITY	DROP LEG	LIFT
BE-715	TOPWIND	7000 LB	8000 LB	NONE	15"

INDUSTRIAL SQUARE BODY TRAILER JACKS

PART#	HANDLE TYPE	MAX LIFT CAPACITY	MAX SUPPORT CAPACITY	DROP LEG	LIFT
BE-700	SIDEWIND	7000 LB	8000 LB	13"	15"

INDUSTRIAL SQUARE BODY TRAILER JACKS

PART#	HANDLE TYPE	MAX LIFT CAPACITY	MAX SUPPORT CAPACITY	DROP LEG	LIFT	HEIGHT
BE-1200	SIDEWIND	10000 LB	12000 LB	13-1/2"	12-1/2"	28-1/2"



REPLACEMENT TRAILER JACK WHEEL ASSEMBLIES

PART#	WHEEL MATERIAL	WHEEL DIAMETER	PIPE SIZE	FITS
TJ-07-02	POLY	6"	1-3/4"	TJ-07-51L
TJ-06-02	POLY	6"	2"	BE-120/130/140 & TJ-01-405



REPLACEMENT TRAILER JACK WHEEL ASSEMBLIES

PART#	WHEEL MATERIAL	WHEEL DIAMETER	PIPE SIZE	FITS
TJ-06-05	STEEL	6"	2"	BE-120/130/140 & TJ-01-405



REPLACEMENT TRAILER JACK WHEELS

PART#	WHEEL MATERIAL	WHEEL DIAMETER	FITS
TJ-06-04	POLY	6"	TJ-06-01K(X) / TJ-01-405 TJ-07-51L



REPLACEMENT TRAILER JACK WHEELS

PART#	WHEEL MATERIAL	WHEEL DIAMETER	FITS
TJ-06-08	POLY	8"	TJ-06-06K



TRAILER JACK BASE

PART#	PIPE SIZE	FITS
TJ-06-03	2" ID	BE-120/130/140



REPLACEMENT DROP LEG

PART#	FITS
BE-705	BE-700/720



MOUNTING PIPES & WELD ON COLLARS

PART#	INSIDE DIAMETER	LENGTH	OUTSIDE DIAMETER	PIN SIZE	SIZE
64.002.000	1-1/2"	1.89"	2"	9/16"	SMALL
64.001.000	2"	2.55"	2-1/2"	9/16"	MEDIUM
64.001.058	2"	2.55"	2-1/2"	5/8"	MEDIUM
64.003.000	2-1/2"	2.55"	3"	9/16"	LARGE
64.003.058	2-1/2"	2.55"	3"	5/8"	LARGE



WELD ON COLLARS

PART#	A	B	C	D
BE-701	63.5 (2.5")	50.8 (2")	63.5 (2-1/2")	114.3 (4-1/2")

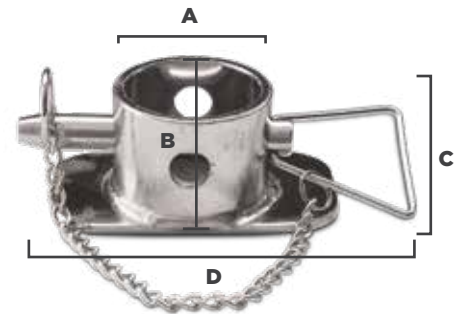

WELD ON COLLAR KITS

PART#	INNER COLLAR ID X OD	OUTER COLLAR ID X OD	PIN SIZE	# OF HOLES	INNER LENGTH	OUTER LENGTH
64.000.916	1.5" X 2"	2.5" X 3"	9/16"	4	1.875"	2.125"
64.000.058	2" X 2.5"	2.55" X 3"	5/8"	4	2.125"	2.5"



FLANGE KIT

PART#	FITS	INCLUDES
FJ-02-20B	FJ-020, FJ530/540	FLANGE, PIN, SPRINGS & CLIP



TRAILER JACK HANDLE ASSEMBLIES & PARTS

PART#	HANDLE TYPE	FITS
XA-003-999	TOPWIND	BE-020/520, BE-555, ST-2104/2154
BE-704	TOPWIND	BE-720



TRAILER JACK HANDLE ASSEMBLIES & PARTS

PART#	HANDLE TYPE	FITS
BE-703	SIDEWIND	BE-050/550/1050, BE-130, FJ-540, TJ-06-01K(X), TJ-07-51L, BE-1020S/1520S
BE-1011	SIDEWIND	BE-1010S
BE-702	GRIP ONLY	BE-703 HANDLE



TRAILER JACK HANDLE ASSEMBLIES & PARTS

PART#	HANDLE TYPE	FITS
BE-1201	SIDEWIND	BE-1200



TRAILER JACK HANDLE ASSEMBLIES & PARTS

PART#	HANDLE TYPE	FITS
BE-1202	RETAINING CLIP	BE-1200



TRAILER JACK PIN & CHAINS

PART#	PIN DIAMETER	PIN LENGTH
BE-025	9/16"	3"
BE-025-CA-1	9/16"	3-1/2"
BE-027	5/8"	3-1/2"



HEAVY DUTY & DELUXE RATCHET STRAPS

PART#	STRAP WIDTH	STRAP LENGTH	WLL	BREAK STRENGTH	COLOR	HOOK TYPE	FEATURES	PACK QTY
64.703.400	1"	6'	600 LB	1800 LB	BLACK	VINYL COATED STEEL HOOKS	RUBBER GRIP, HOOK LOOPS	2 PACK
64.703.300	1"	16'	500 LB	1500 LB	BLACK	VINYL COATED STEEL HOOKS	RUBBER GRIP	1 PACK
64.703.500	1-1/4"	16'	830 LB	2500 LB	BLACK	VINYL COATED STEEL JJ HOOKS	RUBBER GRIP	1 PACK
64.703.600	1-1/2"	16'	1665 LB	5000 LB	BLACK	VINYL COATED STEEL JJ HOOKS	RUBBER GRIP	1 PACK
64.703.000	2"	27'	3300 LB	10,000 LB	BLACK	STEEL JJ HOOKS	RUBBER GRIP, CONTROLLED RELEASE	1 PACK
64.703.100	2"	27'	3300 LB	10,000 LB	BLACK	FLAT HOOKS	RUBBER GRIP, CONTROLLED RELEASE	1 PACK
64.703.200	2"	40'	3300 LB	10,000 LB	BLACK	STEEL JJ HOOKS	CONTROLLED RELEASE	1 PACK



RUBBER GRIP STEEL HOOKS



RUBBER GRIP STEEL HOOKS



RUBBER GRIP STEEL JJ HOOKS



RUBBER GRIP STEEL JJ HOOKS



RUBBER GRIP FLAT HOOKS



CONTROLLED RELEASE STEEL JJ HOOKS

STANDARD DUTY TIE DOWN STRAPS

PART#	STRAP WIDTH	STRAP LENGTH	WLL	BREAK STRENGTH	COLOR	FASTENING TYPE	HOOK TYPE	PACK QTY
64.720.050	1"	6'	400 LB	1200 LB	RED	CAMBUCKLE	VINYL COATED STEEL HOOKS	4 PACK
64.720.001	1"	10'	400 LB	1200 LB	RED	CAMBUCKLE	VINYL COATED STEEL HOOKS	1 PACK
64.720.060	1" 1"	10' 15'	400 LB	1200 LB	BLACK	CAMBUCKLE RATCHET"	VINYL COATED STEEL HOOKS	2 PACK 2 PACK
64.700.001	1"	15'	400 LB	1200 LB	BLUE	RATCHET	VINYL COATED STEEL HOOKS	1 PACK
64.700.002	1"	15'	400 LB	1200 LB	RED	RATCHET	VINYL COATED STEEL HOOKS	1 PACK
64.700.050	1"	15'	400 LB	1200 LB	BLACK	RATCHET	VINYL COATED STEEL HOOKS	4 PACK
64.700.005	1"	15'	650 LB	2000 LB	BLACK	RATCHET	STEEL JJ HOOKS	1 PACK
64.730.001	1"	15'	650 LB	2000 LB	RED	RATCHET	STEEL JJ HOOKS	1 PACK
64.730.002	1"	15'	650 LB	2000 LB	BLACK	RATCHET	STEEL JJ HOOKS	1 PACK
64.710.002	1"	15"	1000 LB	3000 LB	YELLOW	RATCHET	STEEL JJ HOOKS	1 PACK
64.710.003	2"	15"	1250 LB	4000 LB	YELLOW	RATCHET	STEEL JJ HOOKS	1 PACK

COLOR OPTIONS

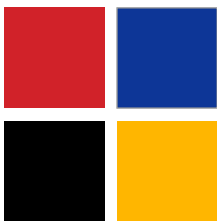

VINYL COATED STEEL HOOKS



CAMBUCKLE SYSTEM

STEEL JJ HOOKS



RATCHET SYSTEM

SINGLE AND MULTI PACK AVAILABLE



ALL TIE DOWNS COME RETAIL PACKAGED

STANDARD DUTY TIE DOWN STRAPS

PART#	ROPE DIAMETER	ROPE LENGTH	WLL	BREAK STRENGTH	COLOR	HOOK TYPE	FEATURES	PACK QTY
64.795.001	1/4"	8'	50 LB	150 LB	BLACK	ZINC PLATED HOOKS	RATCHET CONTROL, THUMB RELEASE	1 PACK
64.795.002	3/8"	8'	85 LB	250 LB	BLACK	ZINC PLATED HOOKS	RATCHET CONTROL, THUMB RELEASE	1 PACK



64.795.001



64.795.002

HEAVY DUTY TRUCK TIE DOWNS

PART#	STRAP WIDTH	STRAP LENGTH	WLL	BREAK STRENGTH	COLOR	FASTENING TYPE	HOOK TYPE	PACK QTY
64.705.344	2"	30'	3300 LB	10,000 LB	YELLOW	WINCH (SOLD SEPARATELY)	FLAT HOOKS	1 PACK
64.705.354	2"	30'	3300 LB	10,000 LB	YELLOW	WINCH (SOLD SEPARATELY)	JJ HOOKS	1 PACK
64.320.881	4"	25'	5400 LB	16,200 LB	YELLOW	WINCH (SOLD SEPARATELY)	JJ HOOKS	1 PACK
64.704.603	4"	30'	5400 LB	16,200 LB	YELLOW	WINCH (SOLD SEPARATELY)	D-RING	1 PACK
64.703.603	4"	30'	5400 LB	16,200 LB	YELLOW	WINCH (SOLD SEPARATELY)	FLAT HOOKS	1 PACK



FLAT HOOK



DOUBLE JJ HOOK



D-RING

4" PORTABLE BOLT ON WINCH

64.705.324



4" STANDARD WELD ON WINCH

67.705.314



BUNGEE CORD

BUNGEE CORD
1100 DTEX POLYESTER
 64.705.873

- 9 mm thick
- 1100 DTEX polyester
- Sold individually or in 48 pack
- Fully adjustable
- Locking safety gate
- Marine grade latex
- UV resistant

**SOLD IN MULTIPLES
 OF 24 ONLY**



BUNGEE CORD
1100 DTEX POLYESTER
 64.705.872

***WHILE QUANTITIES LAST**



BUNGEE CORDS - 48 PACK
 64.705.873B



EPDM RUBBER TARP STRAPS

PART#	STRAP LENGTH	CAPACITY	HOOK TYPE	ADJUSTABLE
64.700.900	9"	50 LB	S	NO
64.701.500	15"	50 LB	S	NO
64.702.100	21"	50 LB	S	NO
64.714.100	41"	50 LB	S	NO
64.702.400	24"	50 LB	S	YES
64.713.100	31"	50 LB	S	YES



REPLACEMENT S HOOKS 5 MM

64.710.040



STEEL STAKE POCKET 1-1/2" X 3-1/4" OPENING, 2-1/2" HIGH BLACK POWDER COATED FINISH 71.000.014



D-RING TIE DOWN WITH FORGED PIN 64.000.888

- 1/2" Ring diameter
- 2-1/2" X 2-1/2" ID
- Working load limit is 4,080 pounds
- Bracket is 1-3/4" wide & 3/16" thick w/square
- Mounting holes to accept 3/8" carriage bolts
- Black powder coating finish



LOAD BINDER SECURING BRACKET 64.100.004



CABLE TYPE BINDER LOCK 64.100.104



RACK HOOKS

PART#	DESCRIPTION
65.500.900	RACK HOOK, 3" LEFT, LIGHT (AL3)
65.500.901	RACK HOOK, 3" RIGHT, LIGHT (AR3)
65.500.904	RACK SOCK EYE (A-1)



65.500.901

65.500.904

65.500.900

HEAVY DUTY TOWING ACCESSORIES

RECOVERY STRAPS

PART#	STRAP WIDTH	STRAP LENGTH	WLL MAX VEHICLE WEIGHT	BREAK STRENGTH	COLOR	STRAP TYPE	CONNECTION TYPE	PACK QTY
64.151.520	2"	20'	7500 LB	15000 LB	YELLOW	STANDARD	LOOPS	1 PACK
64.152.020	2"	20'	10000 LB	20000 LB	YELLOW	STANDARD	LOOPS	1 PACK
64.152.030	2"	30'	7500 LB	15000 LB	YELLOW	STANDARD	LOOPS	1 PACK
64.006.502	3"	20'	13500 LB	27000 LB	YELLOW	HEAVY DUTY	LOOPS	1 PACK
64.006.602	3"	30'	13500 LB	27000 LB	YELLOW	HEAVY DUTY	LOOPS	1 PACK
64.153.630	4"	30'	18000 LB	36000 LB	YELLOW	HEAVY DUTY	LOOPS	1 PACK
64.156.030	6"	30'	27000 LB	54000 LB	YELLOW	HEAVY DUTY	LOOPS	1 PACK
64.153.620	4"	20'	18000 LB	36000 LB	YELLOW	HEAVY DUTY	EYE TO EYE	1 PACK
64.156.020	6"	20'	27000 LB	54000 LB	YELLOW	HEAVY DUTY	EYE TO EYE	1 PACK
64.161.250	6"	50'	60000 LB	120000 LB	ORANGE	HEAVY DUTY	MASTERLINK	1 PACK
64.161.650	8"	50'	80000 LB	160000 LB	ORANGE	HEAVY DUTY	MASTERLINK	1 PACK
64.162.050	10"	50'	100000 LB	200000 LB	ORANGE	HEAVY DUTY	MASTERLINK	1 PACK
64.162.450	12"	50'	120000 LB	240000 LB	ORANGE	HEAVY DUTY	MASTERLINK	1 PACK



RECOVERY STRAP WITH LOOPS



HEAVY DUTY RECOVERY STRAP WITH LOOPS



HEAVY DUTY RECOVERY STRAP WITH EYE TO EYE



HEAVY DUTY RECOVERY STRAP WITH MASTERLINK

LIFT SLINGS

PART#	STRAP WIDTH	STRAP LENGTH	CONNECTION TYPE	VERTICAL	CHOKER	BASKET	COLOR	PACK QTY
64.156.206	2"	6'	TWISTED LOOPS	6200 LB	4960 LBS	12400 LB	YELLOW	1 PACK
64.156.208	2"	8'	TWISTED LOOPS	6200 LB	4960 LBS	12400 LB	YELLOW	1 PACK
64.156.210	2"	10'	TWISTED LOOPS	6200 LB	4960 LBS	12400 LB	YELLOW	1 PACK

THREE TYPES OF USES



BASKET



CHOKER



VERTICAL



LIFTS THOUSANDS OF POUNDS

LOAD BINDERS

LOAD BINDERS ARE CONSTRUCTED FROM DROP FORGED STEEL, HEAT TREATED AND STAMPED WITH WORKING LOAD LIMIT, AND SIZE

MINI LOAD BINDER
64.100.000



PART #	CHAIN SIZE (G30)	WLL
64.100.000	3/16"	250

INDIRECT LOAD BINDER
64.101.002



PART #	CHAIN SIZE		WLL
	(G70)	(G43)	
64.101.002	5/16"	3/8'	5400

LEVER LOAD BINDER
64.100.001



PART #	CHAIN SIZE		WLL
	(G70)	(G43)	
64.100.001		1/4"	2600
64.100.002	5/16"	3/8"	5400
64.100.003	3/8"	1/2"	9200

RATCHET LOAD BINDER
64.199.002



PART #	CHAIN SIZE		WLL
	(G70)	(G43)	
64.199.001		1/4"	2600
64.199.002	5/16"	3/8"	5400
64.199.003	3/8"	1/2"	9200
64.199.004	1/2"	5/8"	13000

FOLDING HANDLE LOAD BINDER
64.198.002



PART #	CHAIN SIZE		WLL
	(G70)	(G43)	
64.198.002	5/16"	3/8"	5400

LOAD BINDER SECURING BRACKET
64.100.004

- Works with mini, indirect and lever binders
- 4.25" length & 1.85" width



LOAD BINDER CABLE LOCK
64.100.104

- Stainless steel cable
- Aluminum stop plate



STAKE POCKET D-RING TIE DOWN
64.000.888

- Fits most standard stake pockets
- 1/2" Ring diameter with 2-1/2" ID
- 4080 lb WLL



GRADE 70 TRANSPORT CHAIN ASSEMBLIES

G70 CHAIN WITH HOOKS

64.020.516



GRADE 70 TIE DOWN CHAIN ASSEMBLIES

- Yellow chromate plated with G70 stamped into every 10th link
- Complete with G70 grab hooks and DOT Tag

PART #	DIAMETER	GRADE	LENGTH	WLL (LBS)
64.016.516	5/16"	70	16'	4700
64.020.516	5/16"	70	20'	4700
64.016.038	3/8"	70	16'	6600
64.020.038	3/8"	70	20'	6600
64.025.038	3/8"	70	25'	6600
64.020.005	1/2"	70	20'	11300

18" G70 CHAIN EXTENSION 2 X 18"

64.218.516



GRADE 70 D-RING CHAIN EXTENSIONS

- 18" Yellow chrome plated extensions
- Complete with G70 grab hook and d-ring

PART #	DIAMETER	GRADE	D-RING WIDTH	WLL (LBS)
64.218.516	5/16"	70	2"	3300
64.318.038	3/8"	70	3"	5400
64.418.038	3/8"	70	4"	6600

AGRICULTURAL SAFETY CHAIN

64.367.516



INCLUDES HOOK

GRADE 70 AGRICULTURAL SAFETY CHAIN FOR TOWED MACHINES

- Yellow chromate plated with G70 stamped into every 10th link
- Complete with G70 safety grab hook, master link and DOT Tag

PART #	DIAMETER.	GRADE	LENGTH	SYSTEM STRENGTH / TOW CAPACITY (LBS)
64.358.014	1/4"	70	58"	10000
64.367.516	5/16"	70	67"	16100
64.362.038	3/8"	70	62"	20200
64.362.012	1/2"	70	62"	40000



GRADE 30 PROOF COIL CHAIN - HOT DIPPED GALVANIZED

PART #	DIAMETER	GRADE	WLL LBS	LENGTH	UOM
35 KG BUCKET OPTIONS					
64.900.316	3/16"	30	800	190'	EA
64.914.110	1/4"	30	1300	110'	EA
64.951.670	5/16"	30	1900	70'	EA
64.938.050	3/8"	30	2650	50'	EA

DRUM OPTIONS

*64.900.025	1/4"	30	1300	800'	FT
*64.900.516	5/16"	30	1900	550'	FT
*64.900.038	3/8"	30	2650	400'	FT
*64.900.050	1/2"	30	4500	200'	FT

***CHAIN IN DRUMS MUST BE ORDERED IN FULL DRUM QUANTITIES**

- Low-strength carbon steel
- General purpose economical chain used in a variety of industries such as light construction, agricultural and marine.

⚠ Not for use for overhead lifting



GRADE 30 PROOF COIL CHAIN - ELECTRO GALVANIZED

PART #	DIAMETER	GRADE	WLL LBS	LENGTH	UOM
35 KG BUCKET OPTIONS					
64.218.400	1/8"	30	400	400'	EA
64.236.190	3/16"	30	800	190'	EA
64.214.110	1/4"	30	1300	110'	EA
64.251.670	5/16"	30	1900	70'	EA
64.238.050	3/8"	30	2650	50'	EA

DRUM OPTIONS

*64.200.025	1/4"	30	1300	400'	FT
*64.200.516	5/16"	30	1900	275'	FT
*64.200.038	3/8"	30	2650	200'	FT
*64.200.050	1/2"	30	4500	200'	FT

***CHAIN IN DRUMS MUST BE ORDERED IN FULL DRUM QUANTITIES**

- Low-strength carbon steel
- General purpose economical chain used in a variety of industries such as light construction, agricultural and marine.

⚠ Not for use for overhead lifting



GRADE 43 HIGH TEST CHAIN - ELECTRO GALVANIZED

PART #	DIAMETER IN.	GRADE	WLL LBS	LENGTH	UOM
DRUM OPTIONS					
*64.300.025	1/4"	43	2600	400'	FT
*64.300.516	5/16"	43	3250	275'	FT
*64.300.038	3/8"	43	5400	200'	FT
*64.300.050	1/2"	43	9200	200'	FT

***CHAIN IN DRUMS MUST BE ORDERED IN FULL DRUM QUANTITIES**

- Carbon steel
- Almost twice as strong as G30 chain, this general purpose chain is commonly used in logging, farming, marine and towing applications.

⚠ Not for use for overhead lifting



GRADE 70 TRANSPORT CHAIN - YELLOW CHROMATE

PART #	DIAMETER	GRADE	WLL LBS	LENGTH	UOM
35 KG BUCKET OPTIONS					
64.114.110	1/4"	70	3150	110'	EA
64.151.670	5/16"	70	4700	70'	EA
64.138.050	3/8"	70	6600	50'	EA

DRUM OPTIONS

*64.100.025	1/4"	70	3150	400'	FT
*64.100.516	5/16"	70	4700	275'	FT
*64.100.038	3/8"	70	6600	200'	FT
*64.100.050	1/2"	70	11300	200'	FT

***CHAIN IN DRUMS MUST BE ORDERED IN FULL DRUM QUANTITIES**

- High strength, heat treated carbon steel
- Load rating of approx. 20% Higher than grade 43. Mainly used for load securement and towing by truckers, loggers and highway crews. Yellow chromate finish for fast identification.
- Transport chain meets department of transportation (dot) regulations and nacm specification

⚠ Not for use for overhead lifting



GRADE 80 ALLOY CHAIN - BLACK OXIDE

PART #	DIAMETER	GRADE	WLL LBS	LENGTH	UOM
DRUM OPTIONS					
*64.108.516	5/16"	80	4500	200'	FT
*64.108.038	3/8"	80	7100	100'	FT
*64.108.050	1/2"	80	12000	100'	FT

*CHAIN IN DRUMS MUST BE ORDERED IN FULL DRUM QUANTITIES



- High strength, heat treated alloy steel
- Rugged, versatile, high strength and low weight. Alloy chain is quenched and tempered before proof testing.
- Meets or exceeds the overhead lifting industry requirements.

GRADE 100 ALLOY CHAIN - BLACK OXIDE

PART #	DIAMETER	GRADE	WLL LBS	LENGTH	UOM
DRUM OPTIONS					
*64.109.516	5/16"	100	5700	100'	FT
*64.109.038	3/8"	100	8800	100'	FT
*64.109.050	1/2"	100	15000	100'	FT

*CHAIN IN DRUMS MUST BE ORDERED IN FULL DRUM QUANTITIES



- High strength, heat treated alloy steel
- Rugged, versatile, high strength and low weight. Alloy chain is quenched and tempered before proof testing.
- Meets or exceeds the overhead lifting industry requirements..

CHAIN CONTAINER SIZES & OPTIONS

35 KG REPLACEMENT BUCKET
64.000.001



P14 DRUM 125 KGS



P15 DRUM 250 KGS



STAND ALONE CHAIN & HOOK PLAN-O-GRAM

HD CHAIN DISPLAY
64.000.000

**18 SPOTS
FOR
HANGING
HOOKS OR
CHAIN
ACCESSORIES!**

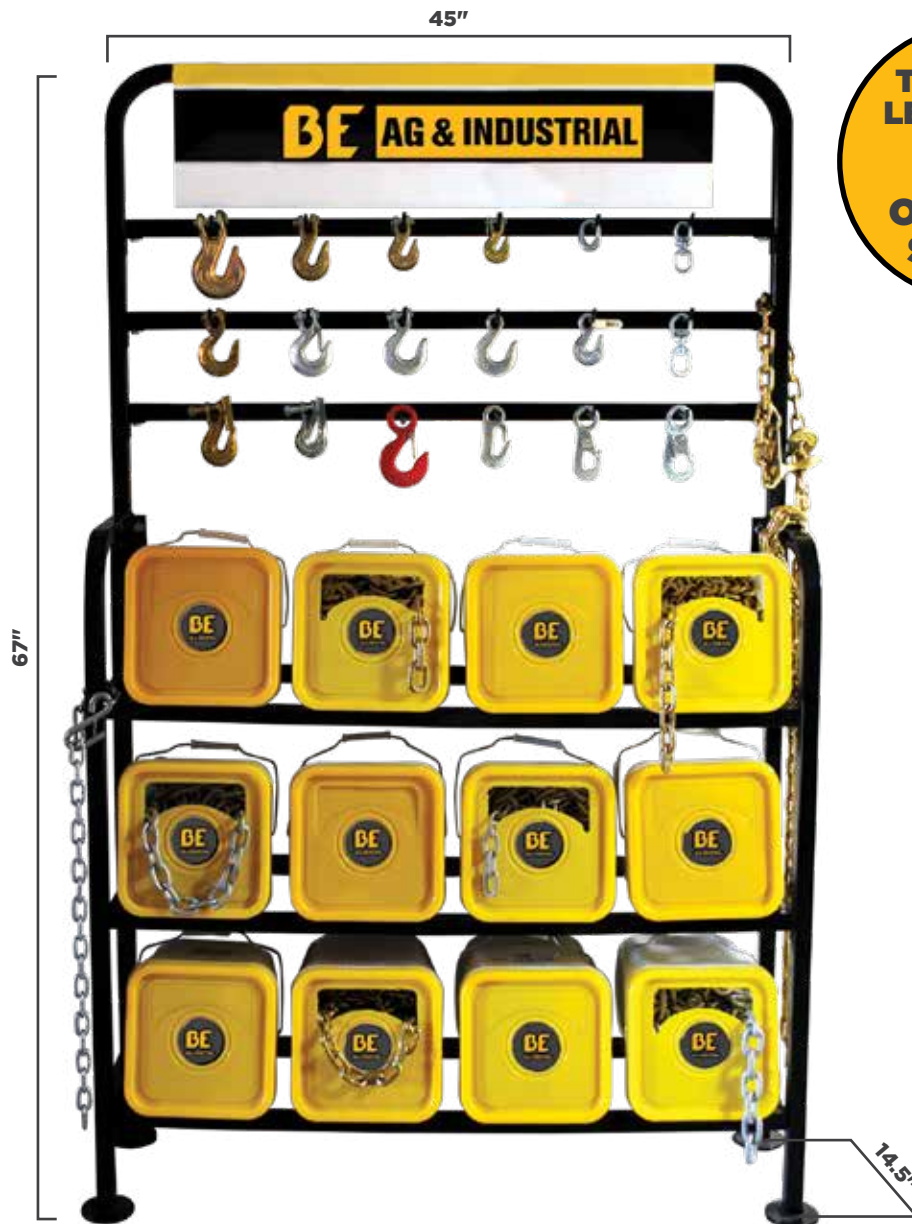

TAKES UP
LESS THAN
4'
OF WALL
SPACE!

CHAIN HOOKS - DISPLAY ITEMS

EYE GRAB HOOK G43

STARTING AT



PART#	SIZE	GRADE	WLL
64.611.006	1/4"	G43	2600 LB
64.611.007	5/16"	G43	3900 LB
64.611.008	3/8"	G43	5400 LB

EYE HOIST HOOK W/LATCH

STARTING AT



PART#	SIZE	WLL
64.612.011	1 TON, 5/16"	2000 LB

EYE HOIST HOOK W/LATCH

STARTING AT



PART#	SIZE	WLL
64.600.010	3/4 TON	1500 LB
64.600.012	1-1/2 TON, 3/8"	3000 LB
64.600.014	3 TON, 1/2"	6000 LB

EYE SLIP HOOK G43

STARTING AT



PART#	SIZE	GRADE	WLL
64.600.006	1/4"	G43	2600 LB
64.600.007	5/16"	G43	3900 LB
64.600.008	3/8"	G43	5400 LB

CLEVIS GRAB HOOK G43

STARTING AT



PART#	SIZE	GRADE	WLL
64.000.009	1/4"	G43	2600 LB
64.000.010	5/16"	G43	3900 LB
64.000.011	3/8"	G43	5400 LB

CLEVIS GRAB HOOK W/LATCH G43

STARTING AT



PART#	SIZE	GRADE	WLL
64.311.009	1/4"	G43	2600 LB
64.311.010	5/16"	G43	3900 LB
64.311.011	3/8"	G43	5400 LB

CLEVIS SLIP HOOK G43

STARTING AT



PART#	SIZE	GRADE	WLL
64.307.006	1/4"	G43	2600 LB
64.307.007	5/16"	G43	3900 LB
64.307.008	3/8"	G43	5400 LB

CLEVIS SLIP HOOK W/LATCH G43

STARTING AT



PART#	SIZE	GRADE	WLL
64.310.006	1/4"	G43	2600 LB
64.310.007	5/16"	G43	3900 LB
64.310.008	3/8"	G43	5400 LB

CHAIN HOOKS - DISPLAY ITEMS

CLEVIS GRAB HOOK G70

STARTING AT



PART#	SIZE	GRADE	WLL
64.100.009	1/4"	G70	3150 LB
64.100.010	5/16"	G70	4700 LB
64.100.011	3/8"	G70	6600 LB
64.100.014	1/2"	G70	11300 LB

CLEVIS GRAB HOOK W/LATCH G70

STARTING AT



PART#	SIZE	GRADE	WLL
64.111.009	1/4"	G70	3150 LB
64.111.010	5/16"	G70	4700 LB
64.111.011	3/8"	G70	6600 LB
64.111.012	1/2"	G70	11300 LB

CLEVIS SLIP HOOK G70

STARTING AT



PART#	SIZE	GRADE	WLL
64.100.006	1/4"	G70	3150 LB
64.100.007	5/16"	G70	4700 LB
64.100.008	3/8"	G70	6600 LB
64.100.013	1/2"	G70	11300 LB

CLEVIS SLIP HOOK W/LATCH G70

STARTING AT



PART#	SIZE	GRADE	WLL
64.110.006	1/4"	G70	3150 LB
64.110.007	5/16"	G70	4700 LB
64.110.008	3/8"	G70	6600 LB
64.110.009	1/2"	G70	11300 LB

WELD-ON BUCKET HOOKS - G70

STARTING AT



PART#	SIZE	GRADE	WLL
64.500.516	5/16"	G70	4700 LB
64.500.038	3/8"	G70	6600 LB
64.500.076	7/16"	G70	8800 LB
64.500.012	1/2"	G70	11300 LB

SAFETY WINCH HOOKS
FORGED CARBON STEEL
 64.612.136



PART #	CHAIN SIZE	HOLE SIZE	WLL
64.612.136	1/4"	3/4"	1500 LB

CHAIN SWIVELS
HOT DIPPED GALVANIZED STEEL
 64.400.444



PART #	CHAIN SIZE	WLL	DESCRIPTION
64.400.444	1/4"	850 LB	EYE & EYE
64.400.445	5/16"	1250 LB	EYE & EYE
64.400.749	3/4"	7200 LB	JAW & EYE

JAW END SWIVEL
3/4" GALVANIZED
 64.400.749



COLD SHUT LINKS
ZINC PLATED FORMED STEEL
 64.602.001



PART #	CHAIN SIZE	WLL
64.602.001	1/4"	750 LB
64.602.002	5/16"	1250 LB
64.602.003	3/8"	1900 LB

REPAIR LINK LAPS
ZINC PLATED MILD STEEL
 64.600.000



PART #	CHAIN SIZE	WLL
64.600.000	1/8"	150 LB
64.600.001	3/16"	200 LB
64.600.002	1/4"	400 LB
64.600.003	5/16"	700 LB
64.600.004	3/8"	1500 LB

GRADE 70 MID-LINK CONNECTORS
YELLOW ZINC PLATED STEEL. G70 STAMP
 64.777.516



PART #	CHAIN SIZE	WLL	GRADE
64.777.516	1/4" - 5/16"	4700LB	G70
64.777.038	3/8"	6600 LB	G70
64.777.050	7/16" - 1/2"	11300 LB	G70

1/8" QUICK LINK
 64.600.030



PART #	CHAIN SIZE	WLL
64.600.030	1/8"	220 LB
64.600.031	3/16"	660 LB
64.600.032	1/4"	880 LB
64.600.033	5/16"	1760 LB
64.600.034	3/8"	2200 LB
64.600.035	7/16"	2640 LB
64.600.036	1/2"	3300 LB

RATED ANCHOR SHACKLES
GALVANIZED
STARTING AT

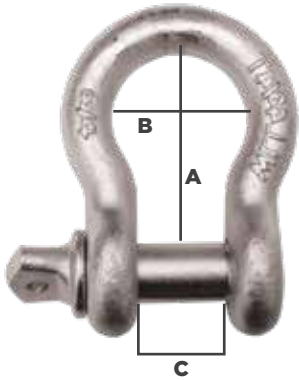

PART#	BODY DIAMETER	PIN DIAMETER	A	B	C	WLL (TONS)
64.400.020	1/4"	5/16"	1-1/8"	3/4"	1/2"	1/2
64.400.021	5/16"	3/8"	1-1/4"	7/8"	1/2"	3/4
64.400.022	3/8"	7/16"	1-7/16"	1"	5/8"	1
64.400.023	7/16"	1/2"	1-11/16"	1-1/8"	3/4"	1-1/2
64.400.024	1/2"	5/8"	1-7/8"	1-5/16"	3/4"	2
64.400.025	5/8"	3/4"	2-3/8"	1-5/8"	1-1/16"	3-1/4
64.400.026	3/4"	7/8"	2-3/4"	2"	1-1/4"	4-3/4
64.400.027	7/8"	1"	3-5/16"	2-1/4"	1-7/16"	6-1/2
64.400.028	1"	1-1/8"	3-3/4"	2-11/16"	1-11/16"	8-1/2
64.400.029	1-1/8"	1-1/4"	4-1/4"	2-5/8"	1-3/4"	9-1/2
64.400.030	1-1/4"	1-3/8"	4-11/16"	3"	2"	12
64.400.031	1-3/8"	1-1/2"	5-1/4"	3-5/8"	2-1/4"	13-1/2
64.400.032	1-1/2"	1-5/8"	5-3/4"	3-7/8"	2-3/8"	17

NON-RATED COMMERCIAL ANCHOR SHACKLE
STARTING AT

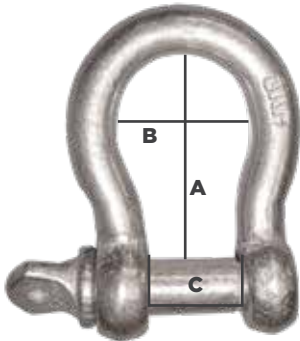

PART#	BODY DIAMETER	PIN DIAMETER	A	B	C	WLL
64.398.020	1/4"	5/16"	1-1/8"	3/4"	1/2"	600 LBS
64.398.021	5/16"	3/8"	1-7/32"	13/16"	17/32"	1/2 TONS
64.398.022	3/8"	7/16"	1-7/16"	15/16"	1-7/16"	3/4 TONS
64.398.023	7/16"	1/2"	1-11/16"	1-5/32"	11/16"	1-1/4 TONS
64.398.024	1/2"	5/8"	1-7/8"	1-5/16"	13/16"	1-1/2 TONS
64.398.025	5/8"	3/4"	2-3/8"	1-11/16"	1-1/16"	2-1/4 TONS

CHAIN SHACKLE
GALVANIZED SCREW
64.400.001

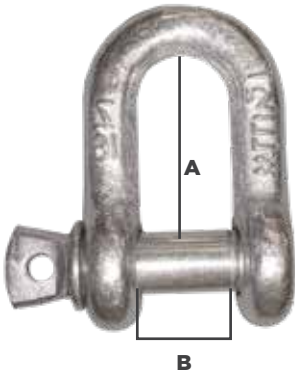

PART#	BODY DIAMETER	PIN DIAMETER	A	B	WLL (TON)
64.400.001	1/4"	5/16"	7/8"	7/16"	1/2
64.400.002	5/16"	3/8"	1"	9/16"	3/4
64.400.003	3/8"	7/16"	1-1/4"	5/8"	1
64.400.004	7/16"	1/2"	1-7/16"	11/16"	1-1/2
64.400.005	1/2"	5/8"	1-5/8"	3/4"	2

ALUMINUM CABLE SLEEVE

64.424.080



ALUMINUM CABLE SLEEVES

PART#	PACK QTY	SIZE
64.424.080	10	1/16" X 3/8"
64.424.081	10	3/32" X 1/2"
64.424.082	10	1/8" X 5/8"
64.424.083	10	5/32" X 9/16"
64.424.084	6	3/16" X 1"
64.424.085	5	1/4" X 1-1/8"

WIRE ROPE CLIP

64.424.001



CLIP, MALLEABLE WIRE ROPE

PART#	SIZE
64.424.001	1/8"
64.424.002	3/16"
64.424.003	1/4"
64.424.004	5/16"
64.424.005	3/8"
64.424.007	1/2"
64.424.008	5/8"
64.424.009	3/4"

CLIP, FORGED WIRE ROPE

PART#	SIZE
64.424.021	1/8"
64.424.022	3/16"
64.424.023	1/4"
64.424.024	5/16"
64.424.025	3/8"
64.424.027	1/2"

THIMBLE

64.424.041



THIMBLE, CABLE

PART#	SIZE
64.424.041	1/8"
64.424.042	3/16"
64.424.043	1/4"
64.424.044	5/16"
64.424.045	3/8"
64.424.047	1/2"

THIMBLE, CABLE HEAVY DUTY

PART#	SIZE
64.424.063	1/4"
64.424.064	5/16"
64.424.065	3/8"
64.424.067	1/2"
64.424.069	5/8"

GALVANIZED AIRCRAFT CABLE

3/32" X 500' ROLL

64.424.999



MINI CABLE CUTTER

64.424.000





TURNBUCKLES FORGED & HOT DIP GALVANIZED

PART#	DESCRIPTION	SIZE
64.395.520 *	HOOK & EYE	3/16" X 3-3/4"
64.395.522 *	HOOK & EYE	1/4" X 4-1/2"
64.395.523 *	HOOK & EYE	1/4" X 6"
64.395.524 *	HOOK & EYE	5/16" X 5-3/4"
64.395.525 *	HOOK & EYE	5/16" X 6-3/4"
64.395.120	HOOK & EYE	1/4" X 4"
64.395.121	HOOK & EYE	5/16" X 4-1/2"
64.395.122	HOOK & EYE	3/8" X 6"
64.395.124	HOOK & EYE	1/2" X 6"



TURNBUCKLES FORGED & HOT DIP GALVANIZED

PART#	DESCRIPTION	SIZE
64.395.100	HOOK & HOOK	1/4" X 4"
64.395.101	HOOK & HOOK	5/16" X 4-1/2"
64.395.102	HOOK & HOOK	3/8" X 6"
64.395.104	HOOK & HOOK	1/2" X 6"



TURNBUCKLES FORGED & HOT DIP GALVANIZED

PART#	DESCRIPTION	SIZE
64.395.140	EYE & EYE	1/4" X 4"
64.395.141	EYE & EYE	5/16" X 4-1/2"
64.395.142	EYE & EYE	3/8" X 6"
64.395.144	EYE & EYE	1/2" X 6"



TURNBUCKLES FORGED & HOT DIP GALVANIZED

PART#	DESCRIPTION	SIZE
64.395.160	JAW & JAW	1/4" X 4"
64.395.161	JAW & JAW	5/16" X 4-1/2"
64.395.162	JAW & JAW	3/8" X 6"
64.395.164	JAW & JAW	1/2" X 6"



SQUARE U BOLTS WITH NUTS

PART#	SIZE
66.200.021	3/8" X 2" X 3"
66.200.022	3/8" X 2" X 5"
66.200.023	3/8" X 4" X 3"
66.200.024	3/8" X 4" X 5"
66.200.025	3/8" X 6" X 5"
66.200.026	3/8" X 6" X 7"



ROUND U BOLTS WITH PLATE & NUTS

PART#	SIZE
66.200.001	1/4" X 1-1/8"
66.200.002	1/4" X 1-3/8"
66.200.003	1/4" X 2"
66.200.004	5/16" X 1-3/8"
66.200.005	5/16" X 1-3/8"
66.200.006	5/16" X 1-3/4"
66.200.007	5/16" X 1-3/4"
66.200.008	5/16" X 2"
66.200.009	5/16" X 2"
66.200.010	5/16" X 2-1/2"
66.200.011	5/16" X 2-1/2"
66.200.012	3/8" X 2-1/2"
66.200.013	3/8" X 3"
66.200.020	3/8" X 3-1/2"

1" SQUARE SWIVEL SNAP
16 KG WLL; MALLEABLE
 68.500.011



3-1/2" OPEN EYE SNAP
30 KG WLL; MALLEABLE
 68.500.020



5/8" SOLID SNAP
16 KG WLL; MALLEABLE
 68.500.040



3-1/2" DOUBLE BOLT SNAP
19 KG WLL; MALLEABLE
 68.500.030



1" SECURITY SNAP
27 KG WLL; MALLEABLE
 68.500.071



3/8" ROUND SWIVEL SNAP
 68.500.001



PART#	DESCRIPTION
68.500.001	3/8", 14 KG WLL; MALLEABLE; NICKEL PLATED
68.500.002	1/2", 16 KG WLL; MALLEABLE; NICKEL PLATED
68.500.003	5/8", 16 KG WLL; MALLEABLE; NICKEL PLATED
68.500.004	3/4", 24 KG WLL; MALLEABLE; NICKEL PLATED

1/2" ROUND SWIVEL SCISSOR SNAPS
 68.500.050



PART#	DESCRIPTION
68.500.050	1/2" 18 KG WLL; MALLEABLE
68.500.051	5/8" 20 KG WLL; MALLEABLE

1/2" PANIC SNAP
 68.500.061



PART#	DESCRIPTION
68.500.061	FIXED EYE 1/2" 24 KG WLL; MALLEABLE
68.500.062	SWIVEL EYE 3/4" 24 KG WLL; MALLEABLE

3/4" SWIVEL EYE LEVER SNAP
24 KG WLL; NICKLE PLATED
 68.500.081



2-7/8" ROPE SNAP
STEEL
 68.500.090



3/8" X 2-1/2" SPRING SNAP
ALLOY STEEL
 68.500.100



3/8" BABY SPRING SNAP
3/8" X 2-1/2"
 68.500.200



LANYARD SAFETY SNAP
 64.612.137



PART#	DESCRIPTION
64.612.137	SINGLE 3/4"
64.612.138	DOUBLE 1"

2" SWIVEL EYE PULLEY BLOCK

68.300.021



PART#	DESCRIPTION
68.300.021	2", 460 LB WLL; MAX CBL DIA: 3/16"
68.300.023	3", 650 LB WLL; MAX CBL DIA: 1/4"

3/4" SWIVEL EYE PULLEY

68.300.015



PART#	DESCRIPTION
68.300.015	3/4", 40 KG WLL
68.300.016	1", 40 KG WLL
68.300.017	1-1/4", 40 KG WLL
68.300.018	1-1/2", 40 KG WLL
68.300.019	2", 40 KG WLL

2" FIXED EYE PULLEY BLOCK

68.300.061



PART#	DESCRIPTION
68.300.061	2", 480 LB WLL; MAX CBL DIA: 3/16"
68.300.062	2-1/2", 550 LB WLL; MAX CBL DIA: 1/4"
68.300.063	3", 650 LB WLL; MAX CBL DIA: 1/4"

3/4" SINGLE FIXED PULLEY

68.300.010



PART#	DESCRIPTION
68.300.010	3/4", 50 KG WLL
68.300.011	1", 50 KG WLL
68.300.012	1-1/4", 80 KG WLL
68.300.013	1-1/2", 80 KG WLL
68.300.014	2", 80 KG WLL

2" DOUBLE SCISSOR BLOCK

68.300.041



PART#	DESCRIPTION
68.300.041	2", 480 LB WLL; MAX CBL DIA: 3/16"
68.300.042	2-1/2", 550 LB WLL; MAX CBL DIA: 1/4"
68.300.043	3", 650 LB WLL; MAX CBL DIA: 1/4"

2" SINGLE SCISSOR BLOCK

68.300.051



PART#	DESCRIPTION
68.300.051	2", 480 LB WLL; MAX CBL DIA: 3/16"
68.300.052	2-1/2", 550 LB WLL; MAX CBL DIA: 1/4"
68.300.053	3", 650 LB WLL; MAX CBL DIA: 1/4"

1/8" S-HOOK

65.600.001



PART#	DESCRIPTION
65.600.001	1/8", WLL 10 KG
65.600.002	5/32", WLL 16 KG
65.600.003	3/16", WLL 25 KG
65.600.004	1/4", WLL 35 KG
65.600.005	5/16", WLL 58 KG

EYEBOLTS, KEYSTOCKS, SPRING CLIPS

LAG SCREW EYEBOLT

68.300.005



PART#	SIZE	MATERIAL
68.300.001	1/4" X 3-3/4"	ZINC PLATED; W/LABEL
68.300.002	1/4" X 5"	ZINC PLATED; W/LABEL
68.300.003	5/16" X 4"	ZINC PLATED; W/LABEL
68.300.004	5/16" X 6"	ZINC PLATED; W/LABEL
68.300.005	3/8" X 4-1/2"	ZINC PLATED; W/LABEL
68.300.006	3/8" X 8"	ZINC PLATED; W/LABEL

WIRE FORMED EYEBOLT

68.400.001



PART#	SIZE	MATERIAL
68.400.001	3/16" X 2"	ZINC PLATED
68.400.002	3/16" X 2-1/2"	ZINC PLATED
68.400.003	1/4" X 2"	ZINC PLATED
68.400.004	1/4" X 2-1/2"	ZINC PLATED
68.400.005	1/4" X 3"	ZINC PLATED
68.400.009	5/16" X 3-1/4"	ZINC PLATED
68.400.010	5/16" X 4"	ZINC PLATED
68.400.011	5/16" X 5"	ZINC PLATED
68.400.012	5/16" X 6"	ZINC PLATED
68.400.013	3/8" X 4"	ZINC PLATED
68.400.014	3/8" X 5"	ZINC PLATED
68.400.015	3/8" X 6"	ZINC PLATED
68.400.016	3/8" X 8"	ZINC PLATED
68.400.017	1/2" X 6"	ZINC PLATED
68.400.018	1/2" X 8"	ZINC PLATED

KEYSTOCK

68.100.201



PART#	SIZE	MATERIAL
68.100.201	3/16" X 3/16" X 12"	ZINC PLATED
68.100.202	1/4" X 1/4" X 12"	ZINC PLATED
68.100.203	5/16" X 5/16" X 12"	ZINC PLATED

SPRING CLIP

65.500.071



PART#	SIZE	MATERIAL
65.500.071	3/16" X 2"	ZINC PLATED
65.500.072	1/4" X 2-3/8"	ZINC PLATED
65.500.074	5/16" X 3-1/8"	ZINC PLATED
65.500.076	3/8" X 4"	ZINC PLATED

3/4" D RING

68.650.001



PART#	SIZE	MATERIAL	WIRE DIA.
68.650.001	3/4"	NICKEL PLATED	1/8"
68.650.003	1"	NICKEL PLATED	1/8"
68.650.005	1-5/16"	NICKEL PLATED	5/32"
68.650.006	1-5/8"	NICKEL PLATED	5/32"
68.650.007	2"	NICKEL PLATED	11/64"

3/4" SPLIT RING

68.650.034



PART#	SIZE	DESCRIPTION
68.650.034	3/4"	LIGHT SPLIT RING, ROUND EDGE
68.650.035	1"	LIGHT SPLIT RING, ROUND EDGE
68.650.036	1-1/4"	SPLIT RING, ANGLE EDGE

1-1/4" HARNESS RING

68.650.002



PART#	SIZE	DESCRIPTION
68.650.002	1-1/4"	NICKEL PLATED; W/LABEL
68.650.004	1-1/2"	NICKEL PLATED; W/LABEL
68.154.580	1/4" X 1"	STEEL

2" RING AND BOLT

68.300.290



PART#	SIZE	MATERIAL
68.300.290	2" RING X 2-1/2" BOLT	ZINC PLATED
68.300.295	2" RING X 4-1/2" LAGSCREW	ZINC PLATED

3/8" X 3-1/2" ROPE HOOK

68.114.010



2" MOUNTING RING AND BRACKET

2" ID X 1-15/16"
1/4" MOUNT HOLE
68.600.995



HYDRAULIC CYLINDERS

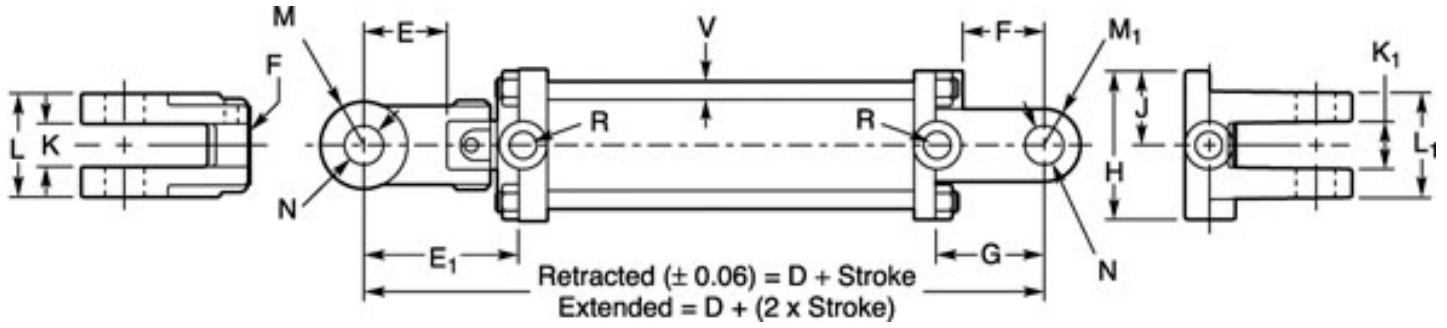

DIMENSION	2"	2.5"	3"	3.5"	4"
D	10-1/4	10-1/4	10-1/4	10-1/4	10-1/4
E	2-1/8	2-1/8	2-1/8	2-1/8	2-1/8
E 1	4-7/16	4-7/16	4-7/16	4-7/16	4-7/16
F	1-5/8	1-5/8	2	2	2
G	2-3/8	2-3/8	2-1/4	2-1/4	2-1/4
H	2-3/4	3-1/8	3-3/4	4-1/4	4-7/8
J	1-3/8	1-9/16	1-7/8	2-1/8	2-7/16
K	1-1/8	1-1/8	1-1/8	1-1/8	1-1/8
K 1	1-1/8	1-1/8	1-1/8	1-1/8	1-1/4
L	2-3/4	2-3/4	2-3/4	2-3/4	2-3/4
L 1	2-1/2	2-1/2	2-9/16	1-3/4	3
M	1-1/8	1-1/8	1-1/8	1-1/8	1-1/8
M 1	1	1	1	1-1/8	1-1/8
N PML	1-1/64	1-1/64	1-1/64	1-1/64	1-1/64
N PMH	1-1/64	1-1/64	1-1/64	1-1/64	1-1/64
P	1-1/8 - 12	1-1/8 - 12	1-1/4 - 12	1-1/4 - 12	1-1/4 - 12
R PML	3/8	3/8	1/2	1/2	1/2
R PMH	3/4 - 16	3/4 - 16	3/4 - 16	3/4 - 16	3/4 - 16
V	3/8	3/8	1/2	5/8	5/8

ASAE 2500 PSI HYDRAULIC CYLINDER
2500PSI
46.002.008



BORE SIZE	PART #	BORE X STROKE	RETRACT LENGTH	ROD DIA.	CLEVIS PIN DIA.	WT. (KG)
2"	46.002.004	2" X 4"	14-1/4"	1-1/8"	1"	
	46.002.008	2" X 8"A	20-1/4"	1-1/8"	1"	8.5
	46.002.010	2" X 10"	20-1/4"	1-1/8"	1"	9.07
	46.002.012	2" X 12"	22-1/4"	1-1/8"	1"	9.53
	46.002.018	2" X 18"	28-1/4"	1-1/8"	1"	
2-1/2"	46.025.008	2-1/2" X 8"A	20-1/4"	1-1/8"	1"	9.98
	46.025.010	2-1/2" X 10"	20-1/4"	1-1/8"	1"	10
	46.025.012	2-1/2" X 12"	22-1/4"	1-1/8"	1"	
3"	46.003.008	3" X 8"A	20-1/4"	1-1/4"	1"	13
	46.003.010	3" X 10"	20-1/4"	1-1/4"	1"	13.7
	46.003.012	3" X 12"	22-1/4"	1-1/4"	1"	14
	46.003.016	3" X 16"	26-1/4"	1-1/4"	1-1/4"	
	46.003.016A	3" X 16"A	31-1/2"	1-1/4"	1"	
	46.003.024	3" X 24"	34-1/4"	1-1/4"	1"	
3-1/2"	46.035.008	3-1/2" X 8"A	20-1/4"	1-1/4"	1"	
	46.035.016	3-1/2" X 16"A	31-1/2"	1-1/2"	1-1/4"	
4"	46.004.008	4" X 8"A	20-1/4"	1-1/2"	1"	17.5
	46.004.024WL	4" X 24"WL	34-1/4"	1-1/4"	1-1/4"	

11 GPM HI/LO HYDRAULIC PUMP
2 STAGE GEAR PUMP, 1/2" SHAFT CW,
11 GPM, NOMINAL FLOW, 3000 PSI
46.333.008



16 GPM HI/LO HYDRAULIC PUMP
2 STAGE GEAR PUMP, 1/2" SHAFT CW,
16 GPM, NOMINAL FLOW, 3000 PSI
46.333.009



HYDRAULIC TOP LINK KITS WITH HOSES & QC COUPLERS

20 - 28" CATEGORY 1 HYDRAULIC TOP LINK KIT
46.120.008

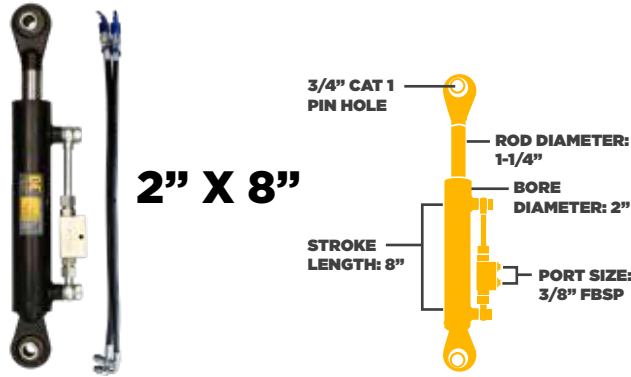

20 - 28" CATEGORY 2 HYDRAULIC TOP LINK KIT
46.220.008

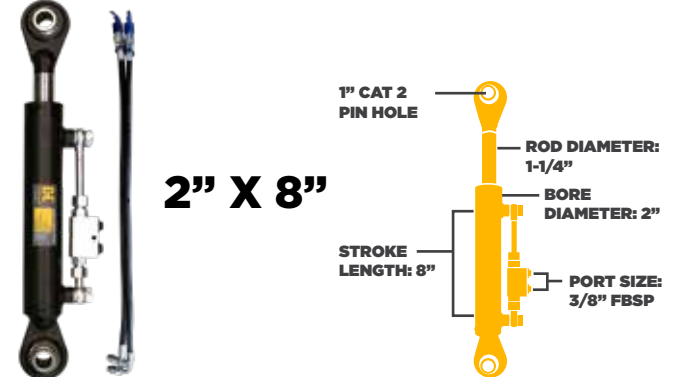

21.5 - 31.5" CATEGORY 2 HYDRAULIC TOP LINK KIT
46.225.010

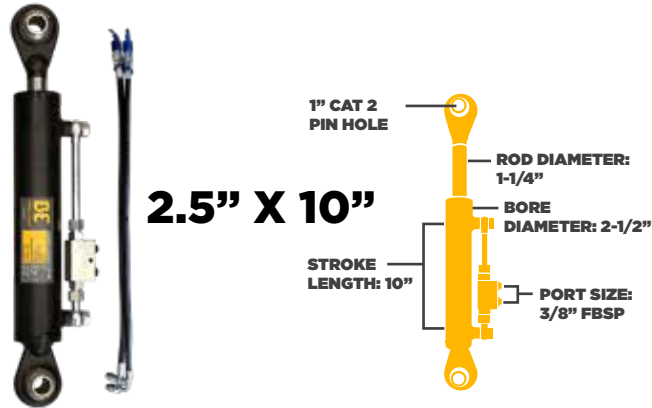

22 - 30" CATEGORY 2 HYDRAULIC TOP LINK KIT
46.230.008

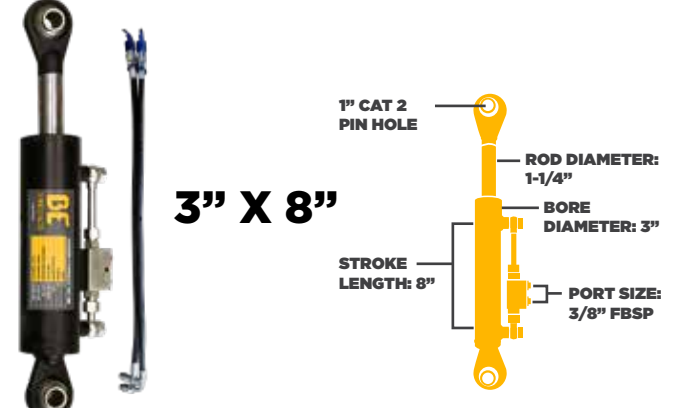

PART NUMBER	46.120.008	46.220.008	46.225.010	46.230.008
CATEGORY	1	2	2	2
COLLAPSED LENGTH	20"	20"	21.5"	22"
EXTENDED LENGTH	28"	28"	31.5"	30"
HOSE LENGTH	36"	36"	36"	36"
OPERATING PRESSURE	2,175 PSI	2,175 PSI	2,175 PSI	2,175 PSI
PUSH CAPACITY	6,490 LBS	6,490 LBS	10,300 LBS	14,600 LBS
PULL CAPACITY	3,830 LBS	3,830 LBS	7,640 LBS	10,850 LBS



HYDRAULIC TOP LINK HOSE KIT WITH Q/C COUPLERS
46.000.038



- 36" hose length
- 1/2" NPT thread tractor end
- 3/8" BSP thread cylinder end
- 3/8" SAE 100 2RAT hose type



5 GALLON HYDRAULIC RESERVOIR

46.333.100

- Black powder coat finish
- Sturdy 12 gauge steel welded construction
- Clip on style breather cap
- Welded-on mounting brackets
- 1-1/2" NPT suction port
- 3/4" NPT return port



CAN BE USED ON A WIDE VARIETY OF APPLICATIONS SUCH AS LOG SPLITTERS OR OTHER SELF-CONTAINED MOBILE HYDRAULIC UNITS!

STROKE CONTROL KITS

46.888.101



PART#	ROD DIAMETER	SEGMENT WIDTH
46.888.100	1-1/8" TO 1-1/4" RODS	3/4", 1", 1-1/4", 1-1/2"
46.888.101	1-3/8" TO 1-1/2" RODS	3/4", 1", 1-1/4", 1-1/2"
46.888.102	1-1/8" TO 1-1/2" RODS, WITH FINGER TABS	3/4", 1", 1-1/4", 1-1/2"
46.888.103	1-3/4" TO 2" RODS, WITH FINGER TABS	1", 1-1/2", 2", 4-1/4"

STROKE CONTROL SEGMENTS

46.888.011



PART#	ROD DIAMETER	SEGMENT WIDTH
46.888.006	1-3/8" TO 1-1/2" RODS	1"
46.888.010	1-3/8" TO 1-1/2" RODS	1-1/2"
46.888.011	2" RODS	1"
46.888.013	2" RODS	2"

MALE COUPLER TIP & FEMALE COUPLER KIT

1/2" FNPT

46.082.012



HYDRAULIC COUPLERS

PART#	DESCRIPTION	PSI RATING	THREAD SIZE
46.080.038	MALE TIP	4410	3/8" FNPT
46.081.038	FEMALE COUPLER	4410	3/8" FNPT
46.080.012	MALE TIP	3625	1/2" FNPT
46.081.012	FEMALE COUPLER	3625	1/2" FNPT
46.082.012	MALE TIP & FEMALE COUPLER KIT	3625	1/2" FNPT

CYLINDER PIN

1" X 2" USL

P-7712



P-7910

PART#	DIAMETER	USABLE LENGTH
P-7712	1"	2"
P-7729	1"	2-3/4"
P-7743	1"	2-7/8"
P-7744	1"	3"
P-7746	1"	3-1/4"
P-7750	1-1/4"	3-1/4"
P-7910	N/A	7/64" SECURING CLIP



JAW COUPLERS

PART#	DESCRIPTION	BORE SIZE	OUTSIDE DIAMETER	KEYWAY SIZE	TYPE	COLOR
72.075.012	COUPLER, SHAFT 1/2" L075	1/2"	1.75"	1/8" X 1/16"	L075	GREEN
72.075.058	COUPLER, SHAFT 5/8" L075	5/8"	1.75"	3/16" X 3/32"	L075	GREEN
72.075.034	COUPLER, SHAFT 3/4" L075	3/4"	1.75"	3/16" X 3/32"	L075	GREEN
72.095.012	COUPLER, SHAFT 1/2" L095	1/2"	2.11"	1/8" X 1/16"	L095	RED
72.095.058	COUPLER, SHAFT 5/8" L095	5/8"	2.11"	3/16" X 3/32"	L095	RED
72.095.034	COUPLER, SHAFT 3/4" L095	3/4"	2.11"	3/16" X 3/32"	L095	RED
72.095.078	COUPLER, SHAFT 7/8" L095	7/8"	2.11"	3/16" X 3/32"	L095	RED
72.095.100	COUPLER, SHAFT 1" L095	1"	2.11"	1/4" X 1/8"	L095	RED
72.095.118	COUPLER, SHAFT 1-1/8" L095	1-1/8"	2.11"	1/4" X 1/8"	L095	RED

RUBBER COUPLER INSERT



PART#	DESCRIPTION	BORE SIZE	KEYWAY SIZE	TYPE	COLOR
72.075.000	L075	SOLID	SOB (NBR)	L075	GREEN
72.095.000	L095	SOLID	SOB (NBR)	L095	RED

MUFFLER CLAMPS

66.100.004



PART#	SIZE
66.100.001	1-1/2"
66.100.002	1-3/4"
66.100.003	1 7/8"
66.100.004	2"
66.100.005	2-1/4"
66.100.006	2-1/2"
66.100.007	2-3/4"
66.100.008	3"
66.100.009	3-1/2"
66.100.010	4"
66.100.011	5"

MUFFLER HANGER

66.100.015



MUFFLER CLAMPS

REPLACES FORD 9N5251;
FITS FORD 2N, 8N, 9N, MF 20, 30, 40 AND 50
100901MC



2" WEATHER / RAIN CAP

66.000.002



PART#	SIZE
66.000.150	1-1/2" - 1-11/16" ADJUSTABLE LENGTH
66.000.175	1-3/4" - 1-15/16" ADJUSTABLE LENGTH
66.000.002	2" - 2-3/16" ADJUSTABLE LENGTH
66.000.225	2-1/4" - 2-7/16" ADJUSTABLE LENGTH
66.000.250	2-1/2" - 2-11/16" ADJUSTABLE LENGTH
66.000.275	2-3/4" - 2-15/16" ADJUSTABLE LENGTH
66.000.003	3" - 3-3/16" ADJUSTABLE LENGTH
66.000.350	3-1/2" - 3-11/16" ADJUSTABLE LENGTH
66.000.004	4" - 4-3/16" ADJUSTABLE LENGTH

DRAWING HOLDER ECONOMY SMALL

67.000.999



HD DRAWING HOLDER DELUXE SMALL

67.221.000



HD DRAWING HOLDER DELUXE LARGE

67.222.000



**WHEEL SPINNER
ALUMINUM**
67.097.060



**WHEEL SPINNER
STANDARD, BLACK**
67.096.060



**WHEEL SPINNER
STANDARD, RED**
67.094.060



**WHEEL SPINNER
DELUXE, BLACK**
67.099.060



**SPARK PLUG CABLES
4 CYLINDER**
CPN12259

- Tractors: All 4 cylinder (1939-1964)
- Copper core
- Rubber boots keep out dirt & moisture for fast starts
- Engineered for reliability & long life



12V TRACTOR CAB FAN - 6"
FCAB6

- Secure with suction cup
- Low noise
- 9 Watt energy saving



18V LITHIUM ION GREASE GUN

67.018.000

- Heavy duty die cast aluminum head
- Air vent (bleeder valve)
- 3 Way loading, 397g (14 oz) cartridge, suction or fast refill bulk loader valve
- Ergonomic handle with rubber grip
- Built in anti-debris filter

30"
EXTRA LONG
GREASE HOSE
WITH BEND
RESTRICTORS

WITH STANDARD
14 OZ
(397G)
GREASE CARTRIDGE
OR WITH
BULK FILLING

DELIVERS APPROX.
3 OZ
PER MINUTE
HIGH FLOW RATE

MAX PSI
10,000
POWERS THROUGH
CLOGGED GREASE
FITTINGS

18V LITHIUM ION BATTERY

67.018.001



18V
LITHIUM
ION



NEW!

INCLUDES

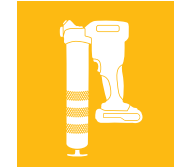

**18V ELECTRIC
GREASE GUN**



**30" EXTRA LONG
GREASE HOSE
WITH BEND
RESTRICTORS**



**HEAVY DUTY
10,000PSI
GREASE
COUPLER**



2x
**(2) 18V
LITHIUM ION
1500 mAh
BATTERY PACKS**



1 HR
**FAST 1 HOUR
BATTERY
CHARGER WITH
LED INDICATOR
LIGHTS**

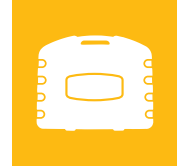

**BLOW MOULD
CASE FOR
STORAGE AND
TRANSPORT**

LEVER ACTION GREASE GUN STANDARD / 10,000 PSI RATING

67.211.000

- Working pressure 4500 PSI
- Air valve to release air locks & priming problems
- 2 Way loading - 14 oz (397g) grease cartridge or suction fill
- Ergonomic rubber grip handle & knurled barrel provide secure grip
- 12" Grease hose & 9" rigid extension with heavy duty coupler included



PRODUCT MAY VARY FROM IMAGE

PNEUMATIC GREASE GUN PISTOL GRIP HANDLE / 6000 PSI

67.000.116

- Delivers 1200-3600 PSI when supplied with 30-90 PSI from compressor
- 2 Way loading - 14 oz (397g) grease cartridge or suction fill
- Ergonomic handle with pistol style trigger provides secure grip and ease of use
- 9" Grease hose with heavy duty coupler and 1/4" npt q/c air fitting included



GREASE GUNS

SUCTION GUN WORKSHOP / 1600Z CAPACITY 21.300.001

- Includes 12" flexible hose
- Zinc plated steel head
- Heavy duty steel barrel with knurled secure grip
- Bottom zinc plated cap can be removed for easy cleaning
- Designed to remove or add gear oils to transfer cases, gearboxes or differentials



MINI PISTOL GRIP GREASE GUN PROFESSIONAL / DEVELOPS 4,500 PSI 21.100.001

- Includes 4" pipe and 12" hose
- Heavy Duty zinc die cast vented gun head
- Thick wall steel barrel knurled for secure grip
- Pistol grip with PVC provides secure grip
- 2 way loading
 - 3 oz (85g) grease cartridge
 - Suction fill
- 1.5 oz (43 g) in 100 strokes
- 90° & 180° delivery pipe locations
- Accessible check valve for easy cleaning of hardened / contaminated grease



PISTOL GRIP GREASE GUN WORKSHOP / DEVELOPS 6,000 PSI 21.100.004

- Includes 6" pipe and 12" hose
- Powder coated steel head
- Steel barrel with knurled secure grip
- Pistol grip with PVC grips
- 2 way loading
 - 14 oz (395 g) grease cartridge
 - Suction fill
- Includes heavy duty 4 jaw coupler



PISTOL GRIP GREASE GUN PROFESSIONAL / DEVELOPS 7,000 PSI 21.100.006

- Includes 6" pipe, 18" hose
- High impact die cast aluminum head
- Heavy Duty steel barrel with knurled secure grip
- Pistol grip with PVC grips
- 3 way loading
 - 14 oz (395 g) grease cartridge
 - Suction fill
- - bulk loader fitting
- 90° & 180° delivery pipe locations
- Accessible check valve for easy cleaning of hardened /contaminated grease
- Includes heavy duty 4 jaw coupler



LEVER ACTION GREASE GUN WORKSHOP / DEVELOPS 8,000 PSI 21.200.004

- Includes 6" pipe, 9" hose
- Painted steel head
- Steel barrel with knurled secure grip
- Lever with ergonomic rubber grip
- 2 way loading
 - 14 oz (395 g) grease cartridge
 - Suction fill
- Accessible check valve for easy cleaning of hardened/contaminated grease
- Includes heavy duty 4 jaw coupler



LEVER ACTION GREASE GUN PROFESSIONAL / DEVELOPS 10,000 PSI 21.200.006

- Includes 10" pipe, 12" hose
- High impact die cast aluminum head
- Heavy duty steel barrel with knurled secure grip
- Lever with ergonomic rubber grip
- 3 way loading
 - 14 oz (395 g) grease cartridge
 - Suction fill
 - Bulk loader fitting
- Accessible check valve for easy cleaning of hardened /contaminated grease
- Includes heavy duty 4 jaw coupler



UNIVERSAL GREASE GUN HOLDER

67.000.019

- Holds grease or suction guns up to 2-1/4" diameter barrels
- Easily mounts on most surfaces such as walls or equipment
- Zinc plated for corrosion & rust resistance



HEAVY DUTY GUN HOLDER

67.000.119

- Heavy duty spring holds 14 oz or 16 oz suction or grease guns
- 4 Bolt hole mounting for mounting on most surfaces
- Black powder coat finish for corrosion & rust resistance



GREASE GUN COUPLERS

WITH BALL CHECKS & HEX NUTS FOR EASY INSTALL/REMOVAL. FITS MOST GREASE GUNS.



PART #	TYPE	NPT (F)	WORKING PSI	BURST PSI	PACKING
67.000.022	90° RIGHT ANGLE	1/8"	1000	N/A	BLISTER
67.000.013*	4-JAW	1/8"	3000	6000	BLISTER
21.310.001	4-JAW	1/8"	3000	6000	BLISTER
67.000.026*	HEAVY DUTY 4-JAW	1/8"	4000	10000	BLISTER
21.310.003	HEAVY DUTY 4-JAW	1/8"	4000	10000	BLISTER

***WHILE QUANTITIES LAST - USE NEW 21.310.00X PART NUMBERS WHEN DEPLETED**

GREASE GUN HOSES

FLEXIBLE HOSES ALLOW FOR USE IN HARD TO REACH AREAS. FITS MOST GREASE GUNS.



PART #	SIZE	TYPE	NPT (M)	WORKING PSI	BURST PSI	PACKING
21.301.012	12"	STANDARD	1/8"	3000	10000	POLY BAG
21.301.018	18"	STANDARD	1/8"	3000	10000	POLY BAG
21.300.012	12"	W/COUPLER & SPRING	1/8"	4500	10000	POLY BAG
21.300.018	18"	W/COUPLER & SPRING	1/8"	4500	10000	POLY BAG

NEEDLE NOSE ADAPTERS

FOR USE IN HARD TO REACH AREAS, SUCH AS CV JOINTS / U-JOINTS. FITS MOST GREASE GUNS.



PART #	SIZE	NPT (F)	PSI	PACKING
67.000.021	1-1/2"	1/8"	3000	BLISTER

GREASE INJECTOR NEEDLES

STAINLESS STEEL W/ PROTECTIVE COVERS. GREAT FOR SEALED BEARINGS & JOINTS. USE ONLY WITH HAND GREASE GUNS.



PART #	GAUGE	LENGTH	PACK QUANTITY	PACKING
67.000.024	18GA	1-1/2"	1	BLISTER
67.000.023	18GA	1-1/2"	3	BLISTER
67.000.025	18GA / 21GA	1-1/2"	2	BLISTER

SAE GREASE FITTINGS

LEAK PROOF, CORROSION RESISTANT FITTINGS HAVE BEEN TESTED UP TO 8000 PSI.
DESCRIPTIVE RETAIL PACKAGING.



PART #	THREAD SIZE	TYPE	PACK QUANTITY	PACKING
67.700.030	1/8" NPT	STRAIGHT	10	CLAMSHELL
67.700.039	1/8" NPT	45°	5	CLAMSHELL
67.700.037	1/8" NPT	90°	6	CLAMSHELL
67.700.031	1/4" - 28	STRAIGHT	10	CLAMSHELL
67.700.040	1/4" - 28 LONG	STRAIGHT	10	CLAMSHELL
67.700.038	1/4" NPT	STRAIGHT	5	CLAMSHELL
67.700.032	1/4" - 28 TAPER	45°	5	CLAMSHELL
67.700.033	1/4" - 28 TAPER	90°	5	CLAMSHELL
67.700.041	5/16" - 24	STRAIGHT	5	CLAMSHELL
67.700.042	3/8" - 24	STRAIGHT	5	CLAMSHELL
67.111.012	1/8", 1/4", 5/16"	45°, 90°, STRAIGHT	12	CLAMSHELL

METRIC GREASE FITTINGS

LEAK PROOF, CORROSION RESISTANT FITTINGS HAVE BEEN TESTED UP TO 8000 PSI.
DESCRIPTIVE RETAIL PACKAGING.



PART #	THREAD SIZE	TYPE	PACK QUANTITY	PACKING
67.700.036	6 MM	STRAIGHT	5	CLAMSHELL
67.700.034	6 MM	45°	5	CLAMSHELL
67.700.035	6 MM	90°	5	CLAMSHELL
67.700.043	8 MM	STRAIGHT	5	CLAMSHELL
67.700.044	8 MM	45°	5	CLAMSHELL
67.700.045	8 MM	90°	6	CLAMSHELL
67.700.046	10 MM	STRAIGHT	5	CLAMSHELL
67.700.047	10 MM	45°	5	CLAMSHELL
67.700.048	10 MM	90°	5	CLAMSHELL

DRIVE IN GREASE FITTINGS

LEAK PROOF, CORROSION RESISTANT FITTINGS HAVE BEEN TESTED UP TO 8000 PSI.
DESCRIPTIVE RETAIL PACKAGING.



PART #	DRILL SIZE	TYPE	PACK QUANTITY	PACKING
67.700.050	3/16"	STRAIGHT	5	CLAMSHELL
67.700.052	1/4"	STRAIGHT	5	CLAMSHELL
67.700.051	5/16"	STRAIGHT	5	CLAMSHELL
67.700.053	3/8"	STRAIGHT	5	CLAMSHELL

GREASE FITTING ASSORTMENTS

SAE, METRIC & DRIVE IN ASSORTMENTS IN REUSABLE CASES.
FIND KIT CONTENTS ON PAGES 189-190.



PART #	SIZING TYPE	RANGE	PACK QUANTITY	PACKING
67.700.304	SAE	1/8" - 1/4"	40	SMALL CASE W/TAB
67.100.100	SAE	1/8" - 1/4"	100	LARGE CASE W/TAB
67.100.110	SAE	1/8" - 1/4"	110	LARGE CASE W/TAB
67.700.314	METRIC	6 MM - 10 MM	50	SMALL CASE W/TAB
67.444.110	METRIC	6 MM - 10 MM	110	LARGE CASE W/TAB
67.700.315	DRIVE IN	3/16" - 3/8"	50	SMALL CASE W/TAB

DRIP TRAY BE1512

- 14" x 14" x 5"
- Includes triangle plastic screen
- Made of durable polypropylene
- Resistant to chemicals
- For containing spills and drips from machinery, vehicles and drums



4 GALLON OIL DRAIN PAN BE1510

- 4 gallon capacity
- Heavy duty polyethylene
- Height: 5-1/2"
- Top internal diameter: 17-3/4"
- Spout outer diameter: 1"



OILERS GREASE FITTING ASSORTMENTS STEEL BODY OILERS OFFERED IN RED OR BLUE.

PART #	TRIGGER TYPE	CAPACITY	SPOUT	COLOR
67.700.320	THUMB	200 ML	RIGID & FLEX	RED
67.700.330	THUMB	300 ML	RIGID & FLEX	RED
67.700.350	THUMB	500 ML	RIGID & FLEX	RED
67.700.100	THUMB	300 ML	RIGID & FLEX	BLUE
67.700.107	THUMB	500 ML	RIGID & FLEX	BLUE
67.700.124	THUMB	700 ML	RIGID & FLEX	BLUE



LOCKABLE DRUM FUNNEL

FIT ALL 2" DRUM BUNG HOLES. INCLUDES LOCKABLE LID DESIGN FOR EXTRA SECURITY & SCREEN. CHEMICAL RESISTANT POLYETHYLENE MATERIAL.

PART #	CAPACITY	TOP DIAMETER	OVERALL HEIGHT	SPOUT LENGTH	SPOUT DIAMETER
B1509	4 QUART	9-1/2"	8-1/2"	1-1/4"	1-1/2"



HEAVY DUTY FUNNELS

INCLUDES HANG TAB FOR CONVENIENT STORAGE, AND SCREEN FILTER. CHEMICAL RESISTANT POLYETHYLENE MATERIAL.

PART #	CAPACITY	TOP DIAMETER	OVERALL HEIGHT	SPOUT LENGTH	SPOUT DIAMETER
B1503	1 PINT	4-1/2"	6"	2-1/4"	1/2"
B1501	2 QUART	6-1/2"	8-1/2"	2-3/8"	1-1/16"
B1502	6 QUART	8-1/2"	10-1/2"	1-5/8"	1-5/16"



CAPPED, DIRT FREE FUNNELS

FEATURES FLEXIBLE SPOUTS, CARRY HANDLE AND SCREEN FILTERS. INCLUDES CAPS FOR TOP AND SPOUT. CHEMICAL RESISTANT POLYETHYLENE MATERIAL.

PART #	CAPACITY	TOP DIAMETER	OVERALL HEIGHT	SPOUT DIAMETER	COLOR
B1504	1 PINT	3"	9-1/2"	1/2"	ORANGE
B1505	1-1/4 QUART	4"	10-1/2"	5/8"	BLUE
B1507	1-1/2 QUART	4"	13-1/4"	1-1/8"	GREEN
B1506	1-1/2 QUART	4"	17"	5/8"	RED



PLASTIC ROTARY BARREL PUMP

67.501.250

- Designed for use with acids, alkalis, gas, diesel, machine oil, water, alcohol, thinners and petroleum based products
- Fits 55 gallon drums; Ryton and Teflon seals
- Delivers 7 gallons per 100 revolutions

**ROTARY HEAD PUMP**

67.500.250

- Cast iron body
- Fits 5 to 55 gallon drums
- Designed for use with non-corrosive based fluids of light to medium viscosity

NOT EXACTLY
AS SHOWN**5 GALLON DRUM PUMP**

67.500.500

- Pumps heavy gear oils.
- Extra long 58" outlet hose.
- Anti drip nozzle.

**BARREL PUMP**

67.502.250

- 1-1/2" and 2" bung for use on drums with either openings
- For use with oil-based fluids
- Dispenses 10 ounces per stroke
- Fits 15 gallon through 55 gallon drum sizes

**55 GALLON HAND OPERATED PUMP**

67.500.550

- Designed for use with acids, alkalis, gas, diesel, machine oil, water, alcohol, thinners and petroleum based products
- Fits 55 gallon drums; Ryton and Teflon seals
- Delivers 7 gallons per 100 revolutions



AIR GREASE LUBRICATOR
5 GALLONS
PRESSURE RATIO 50 : 1
5705AGD



GREASE DISPENSER VALVE
57GUNAGD



- Squeeze handle develops to 8700 PSI
- 1/4" swivel inlet
- Rigid spout

AIR GREASE LUBRICATOR
55 GALLONS
PRESSURE RATIO 55 : 1
5755AGD



- Includes 50' hose, air regulator and grease valve
- Working pressure 70-115 PSI

MOBILE OIL DISPENSER
5 GALLONS
PRESSURE RATIO 3 : 1
5710MOD



- Can be used with engine oil, ATF oil, hydraulic oil, automatic transmission oil, anti-freeze, and allie products
- Working pressure 70-115 PSI, max free flow rate 4 GPM
- LCD control valve shows flows in gallons or liters
- All kits include 50' hose & air regulator

MOBILE OIL DISPENSER
15 GALLONS
PRESSURE RATIO 5 : 1
5715MOD



50' GREASE HOSE
57HOSEAGD



16' GREASE HOSE
58HOSEAGD

- Replacement hose for mobile oil dispensers
- 1/2" fittings
- 3190 PSI rating

**MOBILE AIR OPERATED OIL DISPENSER
FOR 48-55 GALLON DRUMS
PRESSURE REGULATOR WITH GAUGE**
21.500.202



- Digital oil control valve with +/- 0.5 % accuracy
- Pressure regulator with gauge
- Pulsation dampener
- Trolley constructed of heavy gauge steel with tough powder coat finish
- 8" front polyurethane wheels & 6" rear locking swivel castors
- Holds 48-58 gallon drums
- Drum clamp designed into handle
- For use with motor oils, gear oils and antifreeze
- Can be used with up to SAE 320 and gear oil up to # 630
- 21.500.200 includes 16FT oil dispensing hose
- 21.500.202 includes 50FT oil dispensing hose on a heavy duty auto retracting reel

**MOBILE AIR OPERATED OIL DISPENSER
FOR 48-55 GALLON DRUMS
PRESSURE REGULATOR WITH GAUGE**
21.500.200



PUMP SPECIFICATIONS

AIR INLET SIZE	1/4" NPT
MAX FLOW RATE	3.2 GPM
MAX OIL FLOW	12.2 L/MIN
DISCHARGE PORT	1/2" MNPT
MIN AIR PRESSURE	43.5PSI
MAX AIR PRESSURE	116PSI
SUCTION TUBE HEIGHT	37"
RATIO	5:1
MAX OUTLET PRESSURE	218 PSI
FOR CONTAINER SIZE	55 GAL

OIL PUMP
21.700.006



DIGITAL OIL VALVE
21.700.005



- Display available in L/min or GAL/min

50' REEL WITH HOSE
21.700.002



PULSATION DAMPENER
21.700.008





PART#	51.435.006	51.435.007	51.435.008
DESCRIPTION	6" RUBBER	7" RUBBER	8" RUBBER
RIM/HUB	PLASTIC	PLASTIC	PLASTIC
TIRE TYPE	SEMI PNEUMATIC	SEMI PNEUMATIC	SEMI PNEUMATIC
BUSHING (AXLE)	PLASTIC (1/2")	PLASTIC (1/2")	PLASTIC (1/2")
LOAD CAPACITY	65 LBS	65 LBS	110 LBS
CASE QTY	10	10	10



PART#	51.440.006	51.440.007	51.440.008
DESCRIPTION	6" RUBBER	7" RUBBER	8" RUBBER
RIM/HUB	STEEL	STEEL	STEEL
TIRE TYPE	SEMI PNEUMATIC	SEMI PNEUMATIC	SEMI PNEUMATIC
BUSHING (AXLE)	PLATED STEEL (1/2"), BALL BEARING	PLATED STEEL (1/2"), BALL BEARING	PLATED STEEL (1/2"), BALL BEARING
LOAD CAPACITY	110 LBS	110 LBS	175 LBS
CASE QTY	10	10	10



PART#	LSTL57	51.180.800
DESCRIPTION	16" RUBBER	18" RUBBER
RIM/HUB	STEEL	STEEL
TIRE TYPE	PNEUMATIC	PNEUMATIC
BUSHING (AXLE)	PLATED STEEL (3/4"), BALL BEARING	PLATED STEEL (1"), BALL BEARING
LOAD CAPACITY	330 LBS	500 LBS
CASE QTY	5	2

WHEEL ASSEMBLIES



PART#	51.500.850	51.500.850F	51.501.000
DESCRIPTION	8-1/2" RUBBER	8-1/2" RUBBER	10" RUBBER
RIM/HUB	STEEL	STEEL	STEEL
TIRE TYPE	PNEUMATIC	PNEUMATIC	PNEUMATIC
BUSHING (AXLE)	PLATED STEEL (5/8"), BALL BEARING	PLATED STEEL (5/8"), BALL BEARING	PLATED STEEL (5/8"), BALL BEARING
LOAD CAPACITY	220 LBS	220 LBS	285 LBS
CASE QTY	10	10	10



PART#	85.660.004	85.660.004BF	85.660.004YF
DESCRIPTION	10" RUBBER	10" RUBBER	10" RUBBER
RIM/HUB	STEEL	STEEL	STEEL
TIRE TYPE	PNEUMATIC	FOAM-FILLED	FOAM-FILLED
BUSHING (AXLE)	3/4" PLASTIC BUSHING	3/4" PLASTIC BUSHING	3/4" PLASTIC BUSHING
LOAD CAPACITY	285 LBS	285 LBS	285 LBS
CASE QTY	10	10	10



PART#	85.660.006BF	51.501.300	51.501.300F
DESCRIPTION	13" RUBBER	13" RUBBER	13" RUBBER
RIM/HUB	STEEL	STEEL	STEEL
TIRE TYPE	FOAM-FILLED	PNEUMATIC	FOAM-FILLED
BUSHING (AXLE)	3/4" PLASTIC BUSHING	PLATED STEEL (3/4"), BALL BEARING	PLATED STEEL (3/4"), BALL BEARING
LOAD CAPACITY	330 LBS	330 LBS	330 LBS
CASE QTY	10	10	10



PART#	51.484.008	51.450.016	51.450.016Y
DESCRIPTION	16" RUBBER	16" RUBBER	16" RUBBER
RIM/HUB	STEEL	STEEL	STEEL
TIRE TYPE	PNEUMATIC	FOAM-FILLED	FOAM-FILLED
BUSHING (AXLE)	PLATED STEEL (3/4"), BALL BEARING	PLATED STEEL (3/4"), BALL BEARING	PLATED STEEL (3/4"), BALL BEARING
LOAD CAPACITY	330 LBS	330 LBS	330 LBS
CASE QTY	5	5	5

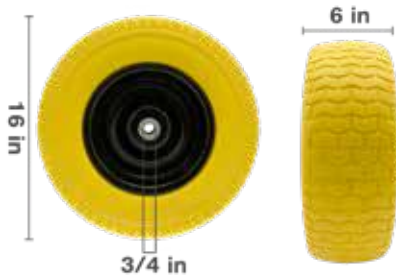

PART#	51.160.600
DESCRIPTION	16" RUBBER
RIM/HUB	STEEL
TIRE TYPE	FOAM-FILLED
BUSHING (AXLE)	PLATED STEEL (3/4"), BALL BEARING
LOAD CAPACITY	330 LBS
CASE QTY	5

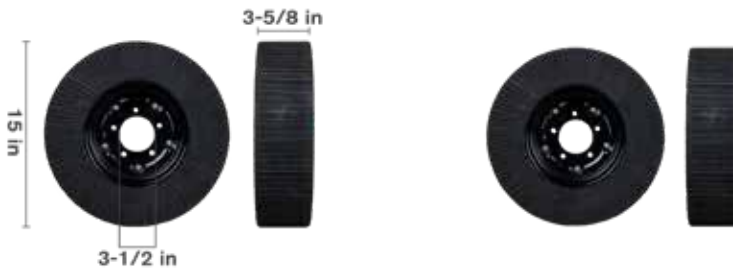

PART#	RC20G	294BE
DESCRIPTION	15"	21"
RIM/HUB	STEEL	STEEL
TIRE TYPE	LAMINATED	LAMINATED
BUSHING (AXLE)	PLATED STEEL (3-1/2")	PLATED STEEL (4")
LOAD CAPACITY	330 LBS	500 LBS
CASE QTY	5	2

WHEEL ASSEMBLIES



PART#	85.660.032	85.660.020F	85.660.050BF
DESCRIPTION	10" RUBBER	13" RUBBER	12" RUBBER
RIM/HUB	STEEL	STEEL	STEEL
TIRE TYPE	FOAM-FILLED	FOAM-FILLED	FOAM-FILLED
BUSHING (AXLE)	PLATED STEEL (3/4"), BALL BEARING	PLATED STEEL (3/4"), BALL BEARING	PLASTIC (3/4")
LOAD CAPACITY	150 LBS	150 LBS	150 LBS
CASE QTY	8	8	8



PART#	51.000.018	51.000.018F
DESCRIPTION	10" RUBBER	10" RUBBER
RIM/HUB	STEEL	STEEL
TIRE TYPE	PNEUMATIC	FOAM-FILLED
BUSHING (AXLE)	STEEL (3/4")	STEEL (3/4")
LOAD CAPACITY	400 LBS	400 LBS
CASE QTY	8	8



PART#	51.500.058	51.500.034
DESCRIPTION	10"	10"
RIM/HUB	STEEL	STEEL
TIRE TYPE	PNEUMATIC	PNEUMATIC
BUSHING (AXLE)	PLATED STEEL (5/8")	PLATED STEEL (3/4")
LOAD CAPACITY	300 LBS	300 LBS
CASE QTY	8	8

RIGID TOP PLATE CASTER
PLASTIC WHEEL
METAL GALVANIZED FRAME
 51.310.150

STARTING AT:

51.310.800



PART#	SIZE	LOAD CAPACITY	CASE QTY
51.310.150	1-1/2"	65 LBS	25
51.310.200	2"	110 LBS	25
51.310.250	2-1/2"	175 LBS	25
51.310.300	3"	220 LBS	25
51.310.400	4"	285 LBS	25
51.310.500	5"	485 LBS	2
51.310.600	6"	550 LBS	2
51.310.800	8"	660 LBS	2

SWIVEL CASTER
PLASTIC WHEEL
METAL GALVANIZED FRAME
 51.320.150

STARTING AT:

51.320.800



PART#	SIZE	LOAD CAPACITY	CASE QTY
51.320.150	1-1/2"	65 LBS	25
51.320.200	2"	110 LBS	25
51.320.250	2-1/2"	175 LBS	25
51.320.300	3"	220 LBS	25
51.320.400	4"	285 LBS	25
51.320.500	5"	485 LBS	2
51.320.600	6"	550 LBS	2
51.320.800	8"	660 LBS	2

SWIVEL WITH SIDE LOCKING BRAKE CASTER
PLASTIC WHEEL
METAL GALVANIZED FRAME
 51.330.150

STARTING AT:

51.330.800



PART#	SIZE	LOAD CAPACITY	CASE QTY
51.330.150	1-1/2"	65 LBS	25
51.330.200	2"	110 LBS	25
51.330.250	2-1/2"	175 LBS	25
51.330.300	3"	220 LBS	25
51.330.400	4"	285 LBS	25
51.330.500	5"	485 LBS	2
51.330.600	6"	550 LBS	2
51.330.800	8"	660 LBS	2

FLAT FREE FOAM CASTER
METAL GALVANIZED FRAME
 51.350.120

STARTING AT:

51.350.130



PART#	SIZE	LOAD CAPACITY	CASE QTY
51.350.120	10"	400 LBS	1
51.350.130	10"	400 LBS	1

SHOP SUPPLIES

TOWELS
SHOP BUCKET REFILL
B55207



ORDER MULTIPLES OF 6

TOWELS
SHOP BUCKET REFILL
B55208



ORDER MULTIPLES OF 2

SHOP TOWELS, HD
(55 TOWEL BOX)
B5440030



ORDER MULTIPLES OF 30

SHOP TOWELS, HD
(55 TOWEL BOX)
B5440012



ORDER MULTIPLES OF 12

SHOP TOWELS, HD
B5025001



ORDER MULTIPLES OF 8

SHOP TOWELS, HD
(200 TOWEL BOX)
B5520201



ORDER MULTIPLES OF 6

PAD, SINGLE OIL ONLY
16" X 20" X 3/16"
B1450



200 PADS / BOX

PAD, OIL ONLY, HD
16" X 20 X 3/8"
B1475



100 PADS / BOX

DRUM TOPPER
UNIVERSAL 2" & 3/4"
OPENINGS
B1488



10 PADS / BOX

PAD
UNIVERSAL 15" X 18"
SORBENT
B1400



100 PADS / BOX

SOCK, UNIVERSAL
CHEMSORB 3" X 48"
B1405



40 SOCKS / CASE

SOCK
OIL ONLY 3" X 48"
B1495



40 SOCKS / CASE

HAND CLEANER
1 GAL, CITRUS
B27128



ORDER MULTIPLES OF 4

HAND CLEANER
1 GAL, PUMICE CITRUS
B28128

HD HAND CLEANER
1 GAL, PUMICE
B28128HD

HAND CLEANER
15 OZ, CITRUS
B27015



ORDER MULTIPLES OF 12

HAND CLEANER
GEL 15 OZ, PUMICE CITRUS
B28015



ORDER MULTIPLES OF 12

HAND CLEANER NUT SHELL
4 L/GAL, 7.3 OZ PUMICE
B29129NUT



ORDER MULTIPLES OF 4

HAND CLEANER NUT SHELL
4 L/GAL, 7.3 OZ PUMICE
B29130CP

HAND CLEANER NUT SHELL
4 L/GAL, 7.3 OZ PUMICE
B29131HD

HAND SCRUBBER WIPES
90 COUNT
B27290



ORDER MULTIPLES OF 6

DISINFECTANT WIPES
80 COUNT
B27291



HAND CLEANER WALL MOUNT DISPENSER
4 L/GAL, 7.3 OZ PUMICE
B28045B



HAND CLEANER WALL MOUNT DISPENSER
4 L/GAL, 7.3 OZ PUMICE
B28128SBR



HAND CLEANER GEL, 4.5 OZ, PUMICE
B28014

HAND CLEANER GEL, 4.5 LB PUMICE
B28045



ORDER MULTIPLES OF 12

ORDER MULTIPLES OF 6

STANDARD YELLOW TRAFFIC VEST
B2700

AVAILABLE ONLY IN US



PREMIUM YELLOW MESH TRAFFIC VEST

LARGE SIZE: B2710L
X-LARGE SIZE: B2710XL

AVAILABLE ONLY IN US



SURVEYORS SAFETY VEST

LARGE SIZE: B2720L
X-LARGE SIZE: B2720XL

AVAILABLE ONLY IN US



STANDARD YELLOW TRAFFIC VEST
B2800

AVAILABLE ONLY IN CANADA



PREMIUM YELLOW MESH TRAFFIC VEST

LARGE SIZE: B2810L
X-LARGE SIZE: B2810XL

AVAILABLE ONLY IN CANADA



SURVEYORS SAFETY VEST

LARGE SIZE: B2820L
X-LARGE SIZE: B2820XL

AVAILABLE ONLY IN CANADA



SAFETY GLASSES
CLEAR LENS, CLEAR FRAME
1209C



- Economic stylized eyewear
- Ideal for service centers, repair shops, farms & other such applications
- Meets ANSI safety ratings

ORDER IN MULTIPLES OF 20

SAFETY GLASSES
MIRROR LENS, BLACK FRAME
1209B



- Economic stylized eyewear
- Tinted to reduce eyestrain in bright conditions, 99% UV protection
- Ideal for outdoor farm & industrial applications
- Meets ANSI safety ratings

ORDER IN MULTIPLES OF 20

GLOVES
LARGE GLOVES, LEATHER PALM
67.999.100



SLOW MOVING VEHICLE SIGNS

SLOW MOVING VEHICLE SIGNS

67.003.020 (THICK PLASTIC)



SLOW MOVING VEHICLE SIGNS

67.003.010 (ALUMINUM)

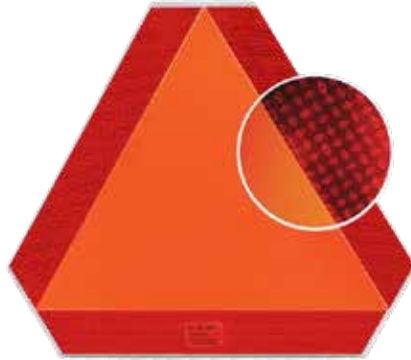

SLOW MOVING VEHICLE SIGNS

67.003.030 (DECAL)



- SMV emblems required for slow moving vehicles on public roads
- Ideal for tractors, combines, plows, tow motors, mowing crews, & other vehicles
- ASAE (S276.6) approved & State of Illinois compliant
- Made with high-intensity, micro-prismatic reflective and fluorescent materials
- Convenient hardware kit available for mounting rigid signs on your equipment.

SLOW MOVING VEHICLE SIGN MOUNT KIT

67.003.040



- Works with aluminum and plastic

SINGLE DISPLAY RACK INCLUDES POP CARD

67.900.107



ROAD SAFETY EQUIPMENT

TRAFFIC PYLON, 18"
SINGLE REFLECTIVE TAPE
67.003.101



TRAFFIC PYLON, 28"
DUAL REFLECTIVE
67.003.107

TRAFFIC PYLON, 36"
REFLECTIVE
67.003.108



COLLAPSIBLE TRAFFIC PYLON
WITH LIGHT
67.003.102



DELINEATOR POST AND BASE, 42"
DUAL REFLECTIVE
67.003.100



TRAFFIC POST, 48" REBOUNDABLE
TRIPLE REFLECTIVE
67.003.105



ROADSIDE SAFETY TRIANGLE
67.003.106



ROADSIDE SAFETY TRIANGLE KIT
3 PACK
67.003.306



WHEEL CHOCK, 4 KG
SOLID RUBBER
67.003.103



TELESCOPING TRAFFIC PYLON BAR /
YELLOW BACK & 2 METER EXTENDED
2 METER BAR
67.003.104



BLACK CABLE TIES

- Indoor/Outdoor rated
- Material: UV Black Nylon
- Max Operating Temperature: 85°C / 185°F
- Min Operating Temperature: -40°C / -40°F
- Min Installation Temperature: 0°C / 32°F



TENSILE STRENGTH



18 LBS

50 LBS

175 LBS

PART#	LENGTH	CABLE TIE WIDTH	CABLE TIE THICKNESS	TENSILE STRENGTH	PACK QTY (PCS)	CASE QUANTITY
67.100.418B	4"	.10"	.04"	18 LBS	100	500 PACKS
67.106.018B	6"				100	400 PACKS
67.506.018B	6"				500	80 PACKS
67.108.050B	8"	.19"	.05"	50 LBS	100	100 PACKS
67.508.050B	8"				500	20 PACKS
67.110.050B	10"				100	100 PACKS
67.510.050B	10"				500	20 PACKS
67.112.050B	12"				100	100 PACKS
67.512.050B	12"				500	20 PACKS
67.016.050B	16"	.35"	.07"	175 LBS	25	200 PACKS
67.116.050B	16"				100	50 PACKS
67.018.050B	18"				25	200 PACKS
67.118.050B	18"				100	50 PACKS
67.024.175B	24"				25	60 PACKS
67.036.175B	36"				25	40 PACKS

WHITE CABLE TIES

- Indoor rated
- Material: natural white nylon
- Max Operating Temperature: 85°C / 185°F
- Min Operating Temperature: -40°C / -40°F
- Min Installation Temperature: 0°C / 32°F



TENSILE STRENGTH



18 LBS

50 LBS

175 LBS

PART#	LENGTH	CABLE TIE WIDTH	CABLE TIE THICKNESS	TENSILE STRENGTH	PACK QTY (PCS)	CASE QUANTITY
67.100.418W	4"	.10"	.04"	18 LBS	100	500 PACKS
67.106.018W	6"				100	400 PACKS
67.108.050W	8"				100	100 PACKS
67.110.050W	10"	.19"	.05"	50 LBS	100	100 PACKS
67.112.050W	12"				100	100 PACKS
67.016.050W	16"				25	200 PACKS
67.018.050W	18"				25	200 PACKS
67.024.175W	24"				25	60 PACKS
67.036.175W	36"				25	40 PACKS

DIGITAL CALIPER 6"

76.150.000

- 150 mm / 6" Measurement Scale
- Stainless Steel,
- Includes Protective Case

**AIR BLOW GUN**

67.000.582

**AIR STORAGE TANK****7 GALLON**

67.000.700

**STANDARD
TIRE AIR CHUCK****AIR BLOW GUN****COMPLETE WITH HOSE, AIR CHUCK, BLOW GUN,
PRESSURE GAUGE, & RELIEF VALVE.**

KIT DISPLAY
POP-KIT4

**GRAB & GO KITS
PLAN-O-GRAM**

**BE'S NEW RANGE OF
GRAB N' GO
HARDWARE KITS**

WILL HAVE YOU COVERED FROM
A TO Z FOR ANY TASK.

WITH ALMOST **30 NEW KITS** ADDED TO
THE RANGE, WE NOW OFFER ONE OF
THE MOST COMPREHENSIVE RANGES OF
ASSORTMENT KITS ON THE MARKET,
COVERING CATEGORIES FROM
**FARM HARDWARE TO ELECTRICAL, AND
FASTENERS TO GENERAL HARDWARE.**

**ENSURE YOU'RE READY FOR
ANY JOB WITH BE'S
GRAB N' GO KITS**



RECEIVE THE MERCHANDISERS FREE WITH THE PURCHASE OF THE COMPLETE PROGRAM.

O-RING, COTTER AND ROLL PIN ASSORTMENT

- Metal storage rack is mountable
- Includes 3 parts trays filled with 1000 popular components
- Extra storage case with handle included for on-the-go jobs
- Large popular variety of springs, cotter pins and roll pins

67.111.000



**1000
PCS**

1/16" X 1" 60PC 3/32" X 1" 40PC	3/32" X 1 1/2" 35PC 1/8" X 1 1/4" 35PC	1/8" X 2" 16PC 5/32" X 2 1/2" 14PC	3/16" X 3" 5PC 1/4" X 2" 5PC	1/4" X 3" 5PC 5/16" X 2 1/2" 5PC
--	---	---	---	---

7/32" X 1 1/2" 20PC 3/8" X 3/4" 20PC	5/16" X 1 1/8" 20PC 3/16" X 1 3/4" 20PC	23/64" X 1 3/8" 20PC 11/32" X 1 7/16" 20PC	7/32" X 1" 30PC 1/4" X 7/8" 30PC	9/32" X 1/2" 30PC 7/32" X 1 1/16" 30PC	9/32" X 2" 20PC 5/16" X 1 3/4" 20PC	5/32" X 3 1/8" 20PC
---	--	---	---	---	--	----------------------------

3/32" X 15/64" 10PC	7/32" X 11/32" 15PC	5/8" X 3/4" 10PC	9/16" X 3/4" 10PC	3/4" X 1" 10PC	3MM X 1.5MM 10PC	10MM X 1.5MM 15PC	13MM X 2.5MM 10PC	19MM X 2.5MM 10PC	20MM X 3.5MM 10PC
1/8" X 1/4" 20PC	1/4" X 3/8" 15PC	3/8" X 9/16" 10PC	5/8" X 13/16" 10PC	13/16" X 1 1/16" 10PC	4.4MM X 2MM 20PC	13MM X 1.5MM 15PC	14MM X 2.5MM 10PC	21MM X 2.5MM 10PC	22MM X 3.5MM 10PC
5/32" X 9/32" 20PC	5/16" X 7/16" 15PC	7/16" X 5/8" 10PC	11/16" X 7/8" 10PC	7/8" X 1 1/8" 10PC	5MM X 2MM 20PC	10MM X 2.5MM 15PC	16MM X 2.5MM 10PC	22MM X 2.5MM 10PC	25.0MM X 3.5MM 5PC
3/16" X 5/16" 20PC	3/8" 1/2" 10PC	1/2" X 11/16" 10PC	3/4" X 15/16" 10PC	15/16" X 1 3/16" 10PC	7MM X 1.5MM 20PC	11MM X 2.5MM 10PC	18MM X 2.5MM 10PC	18MM X 3.5MM 10PC	25MM X 3.5MM 5PC

HARDWARE

ASSORTED KITS

CLEVIS PINS - SAE
 • Constructed of clear zinc plated steel
 • Rust and corrosion resistant
 67.000.060

FARM PINS

60 PCS



5/32" HOLE 1/2" X 1-1/2" 1/2" X 2"	5/32" HOLE 3/8" X 1" 3/8" X 1-1/2" 3/8" X 2"	1/8" HOLE 5/16" X 2" 5/16" X 2-1/4" 5/16" X 2-1/2" 5/16" X 2-3/4"	1/8" HOLE 5/16" X 1" 5/16" X 1-1/4" 5/16" X 1-1/2" 5/16" X 1-3/4"	3/32" HOLE 1/4" X 1-3/4" 1/4" X 2" 1/4" X 2-1/4" 1/4" X 2-1/2"	3/32" HOLE 3/16" X 1" 1/4" X 1" 1/4" X 1-1/4" 1/4" X 1-1/2"
4PC	9PC	7PC	13PC	12PC	15PC

UNIVERSAL CLEVIS PINS - SAE
 • Clear zinc plated steel / corrosion resistant
 • Includes hair pin clips
 67.999.071

FARM PINS

71 PCS



5/64" X 1-5/16"	7/64" X 1-5/8"	3/8" X 2"	7/16" X 2-1/2"	5/16" X 2"
7PC	20PC			5PC
5/64" X 1-9/16"	9/64" X 1-3/4"			1/2" X 2"
7PC	6PC	18PC	5PC	3PC

COTTER PINS - METRIC
 • Constructed of clear zinc plated steel
 • Rust and corrosion resistant
 67.100.555

FARM PINS

555 PCS



1.6 X 25MM	2.4 X 38MM	3.2 X 51MM	2.4 X 25MM	3.2 X 32MM	4.0 X 64MM
150PC	100PC	50PC	150PC	75PC	30PC

COTTER PINS - SAE
 • Constructed of clear zinc plated steel
 • Rust and corrosion resistant
 67.101.000

FARM PINS

1000 PCS



1/16" X 1"	3/32" X 1"	3/32" X 1-1/2"	1/8" X 1-1/4"	1/8" X 2"	5/32" X 2-1/2"
380PC	240PC	140PC	115PC	75PC	50PC

LARGE COTTER PINS - METRIC
 • Constructed of clear zinc plated steel
 • Rust and corrosion resistant
 67.100.144

FARM PINS

144 PCS



3.1 X 50MM	4.0 X 63MM	4.8 X 75MM	6.4 X 50MM	6.4 X 75MM	8.0 X 63MM
50PC	30PC	20PC	20PC	16PC	8PC

ASSORTED KITS

HAIR PINS - SAE

- Constructed of clear zinc plated steel
- Rust and corrosion resistant

67.100.150

FARM PINS

**150
PCS**



3/32" X 1-3/16"	5/64" X 1-5/16"	5/64" X 1-9/16"	7/64" X 1-5/8"	9/64" X 1-3/4"	5/32" X 2-5/8"
42PC	30PC	25PC	25PC	20PC	8PC

LYNCH PINS - SAE

- Yellow zinc plated steel / corrosion resistant
- Four popular sizes for many applications

67.700.200

FARM PINS

**50
PCS**



1/4" X 1-3/4"	3/16" X 1-7/16"	5/16" X 1-3/4"	7/16" X 1-3/4"
18PC	16PC	6PC	10PC

LYNCH PINS & HAIR PINS - SAE

- Zinc plated steel for corrosion resistance
- Most popular sizes of lynch pin and hair pins

67.700.700

FARM PINS

**70
PCS**



5/32" X 2-15/16" 15 PC	7/16" X 1-1/4" 25 PC
1/8" X 1-15/16" 15 PC	
3/32" X 1-5/8" 15 PC	

SQUARE PTO LOCK PINS - SAE

- Zinc plated steel for corrosion resistance
- Four popular sizes for many applications

67.700.220

FARM PINS

**20
PCS**



1/4" X 2-1/2"	3/8" X 2-1/4"	5/16" X 2-1/4"
5PC	5PC	10PC

ROUND PTO LOCK PINS - SAE

- Yellow zinc plated steel / corrosion resistant
- Four popular sizes for many applications

67.701.220

FARM PINS

**20
PCS**



1/4" X 1-3/4"	3/8" X 2-1/4"	5/16" X 2-1/4"
5PC	5PC	10PC

ASSORTED KITS

FASTENERS

HEX HEAD SET SCREWS - SAE

- High quality grade 12.9 screws in fine & coarse thread
- Black oxide finish steel for corrosion resistance

67.984.450

200
PCS



5/32" - 32 X 3/16" 10PC	3/8" - 24 X 3/8" FINE THREAD 10PC	5/16" - 24 X 3/8" FINE THREAD 20PC	5/16" - 18 X 3/8" 30PC	3/8" - 16 X 3/8" 10PC	5/16" - 18 X 1/2" 20PC
1/8" - 40 X 3/16" 10PC	3/16" - 24 X 1/4" 10PC	1/4" - 28 X 1/4" FINE THREAD 20PC	1/4" - 20 X 1/4" 30PC	3/8" - 16 X 1/2" 10PC	1/4" - 20 X 3/8" 20PC

FASTENERS

HEX HEAD SET SCREWS - METRIC

- High quality grade 12.9 screws in fine & coarse thread
- Black oxide finish steel for corrosion resistance

67.984.460

200
PCS



M4 X 5 10PC	M10 X 10 FINE THREAD 10PC	M8 X 10 FINE THREAD 20PC	M8 X 10 30PC	M10 X 10 10PC	M8 X 12 20PC
M3 X 5 10PC	M5 X 6 10PC	M6 X 6 FINE THREAD 20PC	M6 X 6 30PC	M10 X 12 10PC	M6 X 10 20PC

FASTENERS

HEX HEAD CAP SCREWS - SAE

- High quality carbon steel screws in most popular sizes
- Black oxide finish steel for corrosion resistance

67.100.106

106
PCS



#8 - 32 X 1/2" 25PC	#10 - 24 X 1/2" 25PC	#10 - 24 X 1" 20PC	3/8" - 16 X 1-1/2" 3PC	1/4" - 20 X 1" 10PC	5/16" - 18 X 1-1/2" 5PC
			3/8" - 16 X 1" 3PC	1/4" - 20 X 1/2" 10PC	5/16" - 18 X 1" 5PC

FASTENERS

HEX HEAD CAP SCREWS - METRIC

- High quality carbon steel screws in most popular sizes
- Black oxide finish steel for corrosion resistance

67.444.106

106
PCS



4 X 12MM 25PC	5 X 12MM 25PC	5 X 25MM 20PC	10 X 35MM 3PC	6 X 25MM 10PC	8 X 35MM 5PC
			10 X 25MM 3PC	6 X 12MM 10PC	8 X 25MM 5PC

FASTENERS

NUTS, BOLTS & WASHERS - SAE

- Popular variety of bolts, nuts and washers
- Zinc plated steel for corrosion resistance

67.100.240

240
PCS



#10 X 1 10PC	#10 X 5/8" #10 10PC 20PC	1/4" X 3/4" 10PC	3/8" X 5/8" 5PC	1/4" X 1-1/4" 5/16" 10PC 20PC	3/8" X 1-1/2" 5PC
#10 20PC	#5/16 10PC	3/8" 10PC	5/16" X 1" 5/16" 5PC	5/16" X 1-1/2" 5PC	3/8" 10PC
1/4" 20PC	#8 X 3/4" #8 10PC 20PC	#8 X 1/2" #8 10PC 20PC	 5PC 10PC	 5PC	 10PC

ASSORTED KITS

FASTENERS

NUTS, BOLTS & WASHERS - METRIC

- Popular variety of bolts, nuts and washers
- Zinc plated steel for corrosion resistance

67.444.240

240
PCS



M5 X 25 10PC	M5 X 16 M5 10PC 20PC	M6 X 20 10PC	M10 X 16 5PC	M6 X 30 M6 10PC 20PC	M10 X 40 5PC
M5 20PC	M8 10PC	M10 10PC	M4 X 12 M4 5PC 10PC	M8 X 40 5PC	M10 10PC
M6 20PC	M4 X 20 M4 10PC 20PC	M4 X 12 M4 10PC 20PC			

FASTENERS

NYLON LOCK NUTS - METRIC

- Nylon insert acts as lock washer to secure fastener
- Zinc plated steel for corrosion resistance

67.444.146

146
PCS



M4 35PC	M5 35PC	M6 25PC	M8 25PC	M10 16PC	M12 10PC
------------	------------	------------	------------	-------------	-------------

FASTENERS

NYLON LOCK NUTS - SAE

- Nylon insert acts as lock washer to secure fastener
- Zinc plated steel for corrosion resistance

67.000.150

150
PCS

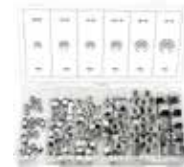

#10-24 25PC	1/4" - 20 35PC	1/4" - 28 25PC	5/16" - 18 30PC	3/8" - 16 25PC	1/2" - 13 10PC
----------------	-------------------	-------------------	--------------------	-------------------	-------------------

FASTENERS

WING NUTS - SAE

- Stamped and machined steel construction
- Zinc plated steel for corrosion resistance

67.110.150

150
PCS



3/16" - 24 30PC	3/16" - 32 30PC	1/4" - 20 25PC	1/4" - 28 25PC	5/16" - 18 20PC	5/16" - 24 20PC
--------------------	--------------------	-------------------	-------------------	--------------------	--------------------

FASTENERS

FLAT & LOCK WASHERS - SAE

- High quality carbon steel construction
- Zinc plated steel for corrosion resistance

67.100.350

350
PCS



#6 LAT WASHER 50PC	#8 FLAT WASHER 40PC	#10 FLAT WASHER 30PC	1/4" FLAT WASHER 25PC	5/16" FLAT WASHER 15PC	3/8" FLAT WASHER 15PC
#6 LOCK WASHER 50PC	#8 LOCK WASHER 40PC	#10 LOCK WASHER 30PC	1/4" LOCK WASHER 25PC	5/16" LOCK WASHER 15PC	3/8" LOCK WASHER 15PC

ASSORTED KITS

FASTENERS

FLAT & LOCK WASHERS - METRIC

- Popular variety of lock, internal & external star washers
- Zinc plated steel for corrosion resistance

67.444.350



350
PCS

3MM LAT WASHER	4MM FLAT WASHER	5MM FLAT WASHER	6MM FLAT WASHER	8MM FLAT WASHER	10MM FLAT WASHER
50PC	40PC	30PC	25PC	15PC	15PC
3MM OCK WASHER	4MM LOCK WASHER	5MM LOCK WASHER	6MM LOCK WASHER	8MM LOCK WASHER	10MM LOCK WASHER
50PC	40PC	30PC	25PC	15PC	15PC

FASTENERS

LOCK WASHER KIT

- High quality alloy steel construction
- Zinc plated steel for corrosion resistance

67.100.720



720
PCS

#6 SPRING CUSHIONS COUSSINS À RESSORT	#8 SPRING CUSHIONS COUSSINS À RESSORT	#10 SPRING CUSHIONS COUSSINS À RESSORT	1/4" SPRING CUSHIONS COUSSINS À RESSORT	5/16" SPRING CUSHIONS COUSSINS À RESSORT	3/8" SPRING CUSHIONS COUSSINS À RESSORT
50PC	50PC	50PC	40PC	30PC	20PC
#6 EXTERNAL WASHERS RONDELLES EXTERNES	#8 EXTERNAL WASHERS RONDELLES EXTERNES	#10 EXTERNAL WASHERS RONDELLES EXTERNES	1/4" EXTERNAL WASHERS RONDELLES EXTERNES	5/16" EXTERNAL WASHERS RONDELLES EXTERNES	3/8" EXTERNAL WASHERS RONDELLES EXTERNES
50PC	50PC	50PC	40PC	30PC	20PC
#6 INTERNAL WASHERS RONDELLES INTERNES	#8 INTERNAL WASHERS RONDELLES INTERNES	#10 INTERNAL WASHERS RONDELLES INTERNES	1/4" INTERNAL WASHERS RONDELLES INTERNES	5/16" INTERNAL WASHERS RONDELLES INTERNES	3/8" INTERNAL WASHERS RONDELLES INTERNES
50PC	50PC	50PC	40PC	30PC	20PC

FASTENERS

MAGNETIC BIT HOLDER & ASSORTED BITS

- 6 X magnetic 1/4" bit holders included
- Assortment of Pozidriv®, Philips®, Slotted, Hex and Torx® bits

67.999.114



114
PCS

PZ1	PZ2	PZ3	PH0	PH1	PH2
6PC	6PC	6PC	6PC	6PC	6PC
SL4	SL5	SL6	H2	H3	H4
6PC	6PC	6PC	6PC	6PC	6PC
H5	H6	T10	T20	T25	T30
6PC	6PC	6PC	6PC	6PC	6PC
 MAGNETIC BIT HOLDER 6PC					

FASTENERS

ALUMINUM RIVETS - SAE

- Rustproof aluminum heads & steel shanks
- Four popular sizes of 1/8" diameter rivets

67.100.500



500
PCS

1/8" X 1/4"	1/8" X 4/16"	1/8" X 3/8"	1/8" X 5/8"
125PC	125PC	125PC	125PC

HARDWARE

INTERNAL & EXTERNAL SNAP RINGS - SAE

- Constructed of heat treated durable spring steel
- Black oxide finish steel for corrosion resistance

67.100.285



285
PCS

7/16"	5/8"	5/8"	9/16"	5/8"	3/4"
15PC	15PC	20PC	20PC	20PC	20PC
1/2"	3/4"	1-1/4"	1"	7/8"	13/16"
15PC	15PC	5PC	10PC	10PC	10PC
9/16"	13/16"	7/16"	3/8"	5/16"	1/4"
15PC	15PC	15PC	20PC	20PC	20PC

ASSORTED KITS

HARDWARE

EXTERNAL SNAP RINGS - METRIC

- Constructed of heat treated durable spring steel
- Black oxide finish steel for corrosion resistance

67.100.300

300
PCS



3MM 20PC	6MM 25PC	11MM 15PC	13MM 25PC	16MM 20PC	22MM 20PC
4MM 10PC	8MM 15PC	32MM 5PC	28MM 10PC	19MM 25PC	25MM 15PC
5MM 15PC	10MM 20PC	12MM 15PC	14MM 15PC	20MM 15PC	26MM 15PC

HARDWARE

INTERNAL SNAP RINGS - METRIC

- Constructed of heat treated durable spring steel
- Black oxide finish steel for corrosion resistance

67.200.300

300
PCS



3MM 20PC	4MM 10PC	5MM 15PC	6MM 25PC	8MM 15PC	9MM 20PC
20MM 15PC	22MM 20PC	25MM 15PC	26MM 15PC	28MM 10PC	32MM 5PC
11MM 15PC	12MM 15PC	13MM 25PC	14MM 15PC	15MM 20PC	19MM 25PC

HARDWARE

EXTERNAL E-CLIPS - METRIC

- Constructed of heat treated durable spring steel
- Black oxide finish steel for corrosion resistance

67.300.300

300
PCS



1.5MM 30PC	3MM 30PC	5MM 40PC	15MM 20PC	19MM 20PC	22MM 20PC
6MM 50PC	10MM 50PC	12MM 40PC			

HARDWARE

ROLL PINS - SAE

- Constructed of heat treated durable spring steel
- Black oxide finish steel for corrosion resistance

67.100.120

120
PCS



5/32" X 5/8" 5/32" X 1" 5/32" X 1 1/2" 4 PC	1/4" X 5/8" 1/4" X 1 1/4" 1/4" X 1 3/4" 4 PC			3/32" X 5/8" 3/32" X 1" 3/32" X 1 1/4" 4 PC	1/8" X 5/8" 1/8" X 1" 1/8" X 1 1/4" 5 PC
5/64" X 1/4" 5/64" X 1/2" 5/64" X 1" 4 PC	1/16" X 3/16" 1/16" X 3/4" 1/16" X 5/16" 4 PC	5/16" X 3/4" 5/16" X 1 1/2" 5/16" X 2" 4 PC	3/8" X 3/4" 3/8" X 1 1/2" 3/8" X 2" 2 PC	7/32" X 1 1/4" 7/32" X 1 3/4" 7/32" X 5/8" 4 PC	3/16" X 5/8" 3/16" X 1" 3/16" X 1 1/4" 5 PC

HARDWARE

ROLL PINS - METRIC

- Constructed of heat treated durable spring steel
- Black oxide finish steel for corrosion resistance

67.444.120

120
PCS



4 X 16 4 X 25 4 X 40 4 PC	6 X 16 6 X 30 6 X 45 4 PC			2.5 X 16 2.5 X 25 2.5 X 30 4 PC	3 X 16 3 X 25 3 X 30 5 PC
2 X 16 2 X 12 2 X 25 4 PC	1.5 X 5 1.5 X 20 1.5 X 8 4 PC	8 X 20 8 X 40 8 X 50 4 PC	10 X 20 10 X 40 10 X 50 2 PC	5.5 X 30 5.5 X 45 5.5 X 16 4 PC	5 X 16 5 X 25 5 X 30 5 PC

ASSORTED KITS

HARDWARE

STAINLESS STEEL HOSE CLAMPS

- Heavy duty 304 stainless steel band & zinc plated gear
- Popular sizes from 5/8" to 1-1/2"

67.999.026



26
PCS

5/8" (10-16MM)	1" (16-25MM)	1-1/16" (14-27MM)	1-1/4" (18-32MM)	7/8" (1-22MM)
8PC	4PC	2PC	2PC	6PC
		1-1/2" (21-38MM)		
		4PC		

HARDWARE

STAINLESS STEEL HOSE CLAMPS - KEY TYPE

- Heavy duty 304 stainless steel band & zinc plated gear
- Popular sizes included & no tools required

67.991.026



26
PCS

7/8" (22MM)	1" (25MM)	1/2" (13MM)	5/8" (16MM)	3/4" (19MM)
2PC	2PC	10PC	6PC	6PC

HARDWARE

COPPER WASHERS - SAE

- Corrosion resistant and high conductivity
- Ideal for sump plugs, fuel, water or electrical connections

67.000.110



110
PCS

1/4"	5/16"	3/8"	7/16"	1/2"	5/8"
30PC	25PC	20PC	15PC	10PC	10PC

HARDWARE

WIRE ROPE CLIPS AND SHACKLES

- Zinc plated steel/corrosion resistant
- Popular sizes of wire rope & carabiner clips and shackles

67.999.030



30
PCS

5 X 50MM 4PC	8 X 80MM 2PC	10 X 100MM 1PC	3MM 5PC	8MM 3PC
6 X 60MM 3PC		6MM 4PC	5MM 5PC	
		8MM 3PC		

HARDWARE

COMPRESSION AND EXTENSION SPRINGS

- Constructed of #75 zinc plated steel for durability
- Great for DIY projects, home repairs or hand tool repairs

67.000.200



200
PCS

COMP. 7 x 1.25MM EXT. 5 x 20.5MM 10PC	COMP. 9.5 x 16MM EXT. 8 x 28.5MM 6PC	COMP. 9.5 x 19MM EXT. 8 x 31.5MM 8PC	FIRST FRACTION - OUTSIDE DIAMETER SECOND FRACTION - LENGTH		COMP. 9 x 35MM EXT. 5 1011 4.5 x 44.5MM 8PC	COMP. 5.5 x 38MM EXT. 7 x 19MM 10PC
COMP. 6.5 x 10MM EXT. 5 x 25.5MM 10PC	COMP. 5.5 x 17.5MM EXT. 6.5 x 22MM 10PC	EXT. 8.5 x 47MM 12PC	EXT. 7 x 51MM 12PC	EXT. 8 x 44.5MM 10PC	EXT. 4 x 79.5MM 10PC	EXT. 8.5 x 36.5MM 10PC

HARDWARE

EXTENSION SPRING ASSORTMENT

- Black oxide plated steel for durability & corrosion resistance
- Great for DIY projects, home repairs or hand tool repairs

67.100.054

54
PCS



0.015"X0.125"X1.8" 0.025"X0.25"X1.8" 0.035"X0.25"X1.8" 0.05"X0.312"X1.8" 0.025"X0.343"X1.8" 0.025"X0.437"X1.8"	0.08"X0.5"X1.625"	0.02"X0.156"X2.5" 0.016"X0.25"X2.5" 0.035"X0.25"X2.5" 0.025"X0.437"X2.5" 0.047"X0.437"X2.5"	0.030"X0.437"X2.75" 0.047"X0.437"X3.5"	0.047"X0.437"X3.5" 0.054"X0.437"X3.5"	0.025"X0.375"X4" 0.047"X0.375"X3.75"
2PC EACH	4PC EACH	2PC EACH	4PC EACH	2PC EACH	2PC EACH
0.02"X0.156"X3.875" 0.025"X0.25"X1.875" 0.025"X0.39"X1.875" 0.025"X0.343"X1.875" 0.025"X0.437"X1.875" 0.047"X0.437"X1.875"	0.062"X0.437"X2"				
2PC EACH	4PC EACH	2PC EACH	4PC EACH	2PC EACH	2PC EACH

HARDWARE

COMPRESSION SPRING

- Black oxide plated steel for durability & corrosion resistance
- Great for DIY projects, home repairs or hand tool repairs

67.100.114

114
PCS



0.062"X0.25"X2.5" 0.025"X0.25"X1.875" 0.025"X0.312"X1.875"	0.025"X0.156"X1.875" 0.016"X0.25"X1.875" 0.035"X0.25"X1.875" 0.025"X0.437"X1.875" 0.047"X0.437"X1.875"	0.025"X0.156"X1.875" 0.016"X0.25"X1.875" 0.035"X0.25"X1.875" 0.025"X0.437"X1.875" 0.047"X0.437"X1.875"	0.015"X0.25"X1.875" 0.025"X0.25"X1.875" 0.035"X0.25"X1.875" 0.025"X0.437"X1.875" 0.047"X0.437"X1.875"	0.015"X0.25"X1.875" 0.025"X0.25"X1.875" 0.035"X0.25"X1.875" 0.025"X0.437"X1.875" 0.047"X0.437"X1.875"	0.015"X0.25"X1.875" 0.025"X0.25"X1.875" 0.035"X0.25"X1.875" 0.025"X0.437"X1.875" 0.047"X0.437"X1.875"
6PC EACH	6PC EACH	4PC EACH	4PC EACH	2PC EACH	2PC EACH
0.025"X0.156"X1.875" 0.016"X0.25"X1.875" 0.035"X0.25"X1.875" 0.025"X0.437"X1.875" 0.047"X0.437"X1.875"	0.025"X0.156"X1.875" 0.016"X0.25"X1.875" 0.035"X0.25"X1.875" 0.025"X0.437"X1.875" 0.047"X0.437"X1.875"	0.015"X0.25"X1.875" 0.025"X0.25"X1.875" 0.035"X0.25"X1.875" 0.025"X0.437"X1.875" 0.047"X0.437"X1.875"	0.015"X0.25"X1.875" 0.025"X0.25"X1.875" 0.035"X0.25"X1.875" 0.025"X0.437"X1.875" 0.047"X0.437"X1.875"	0.015"X0.25"X1.875" 0.025"X0.25"X1.875" 0.035"X0.25"X1.875" 0.025"X0.437"X1.875" 0.047"X0.437"X1.875"	0.015"X0.25"X1.875" 0.025"X0.25"X1.875" 0.035"X0.25"X1.875" 0.025"X0.437"X1.875" 0.047"X0.437"X1.875"
2PC EACH	4PC EACH	2PC EACH	2PC EACH	2PC EACH	2PC EACH

HARDWARE

WOODRUFF KEYS - METRIC

- Constructed of heat treated carbon steel
- Black oxide finish steel for corrosion resistance

67.200.080

80
PCS



4 x 7.5 x 19	5 x 7.5 x 19	3 x 5 x 13	3 x 6.5 x 16	5 x 9 x 22	6 x 9 x 22
		10PC	10PC		
		4 x 5 x 13	4 x 6.5 x 16		
10PC	10PC	10PC	10PC	10PC	10PC

HARDWARE

HNBR O-RINGS - SAE / METRIC

- HNBR - hydrogenated nitrile butadiene rubber
- For use with air conditioning applications

67.700.270

270
PCS



7/32" X 1/16"	1/4" X 1/16"	9/32" X 5/64"	5/16" X 1/16"	5/16" X 5/64"	11/32" X 5/64"
20PC	20PC	20PC	20PC	20PC	20PC
7/16" X 1/16"	7/16" X 3/32"	9/16" X 1/16"	9/16" X 3/32"	11/16" X 1/16"	11/16" X 1/8"
15PC	15PC	10PC	10PC	10PC	10PC
8MM X 2MM	10MM X 2MM	10MM X 2MM	12MM X 2MM	15MM X 2MM	17MM X 2MM
20PC	10PC	15PC	15PC	10PC	10PC

HARDWARE

NITRILE O-RINGS - SAE

- NBR - nitrile butadiene rubber (BUNA-N 70)
- Rubber resists oil, gas, water, and alcohol solvents

67.100.225

225
PCS



3/32" x 15/64"	1/8" x 1/4"	5/32" x 9/32"	3/16" x 5/16"	7/32" x 11/32"	1/4" x 3/8"
10PC	20PC	20PC	20PC	15PC	15PC
9/16" x 3/4"	5/8" x 13/16"	11/16" x 7/8"	3/4" x 15/16"	3/4" x 1"	13/16" x 1-1/16"
10PC	10PC	10PC	10PC	10PC	10PC
5/16" x 7/16"	3/8" x 1/2"	5/8" x 3/4"	3/8" x 9/16"	7/16" x 5/8"	1/2" x 11/16"
10PC	10PC	10PC	10PC	10PC	10PC

ASSORTED KITS

HARDWARE

NITRILE O-RINGS - METRIC

- NBR - nitrile butadiene rubber (BUNA-N 70)
- Rubber resists oil, gas, water, and alcohol solvents

67.444.225



225
PCS

3 x 1 20PC	4 x 1 20PC	4.5 x 2 20PC	5 x 2 20PC	6 x 2 20PC	6 x 2.5 20PC
13 x 3 5PC	14 x 2.5 5PC	17 x 2.5 5PC	18 x 4 5PC	20 x 2 5PC	22 x 2 5PC
6 x 3 20PC	7 x 2 20PC	8 x 2 20PC	9 x 2 5PC	10 x 2 5PC	12 x 3 5PC

HARDWARE

NITRILE O-RINGS - SAE

- NBR - nitrile butadiene rubber (BUNA-N 70)
- Rubber resists oil, gas, water, and alcohol solvents

67.100.407

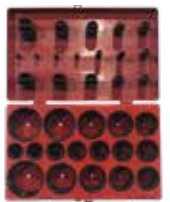

407
PCS

NUMBERS	I/D	O/D	SECTION	QTY	NUMBERS	I/D	O/D	SECTION	QTY	NUMBERS	I/D	O/D	SECTION	QTY			
R-01	006	1/8	1/4	1/16	20	R-12	115	11/16	7/8	3/32	13	R-23	217	1 3/16	1 7/16	1/8	10
R-02	008	3/16	5/16	1/16	20	R-13	116	3/4	15/16	3/32	13	R-24	218	1 1/4	1 1/2	1/8	10
R-03	010	1/4	3/8	1/16	20	R-14	117	13/16	1	3/32	13	R-25	219	1 5/16	1 9/16	1/8	10
R-04	011	5/16	7/16	1/16	20	R-15	118	7/8	1 1/16	3/32	13	R-26	220	1 3/8	1 5/8	1/8	10
R-05	012	3/8	1/2	1/16	20	R-16	210	3/4	1	1/8	10	R-27	221	1 7/16	1 11/16	1/8	10
R-06	014	1/2	5/8	1/16	20	R-17	211	13/16	1 1/16	1/8	10	R-28	222	1 1/2	1 3/4	1/8	10
R-07	110	3/8	9/16	3/32	13	R-18	212	7/8	1 1/8	1/8	10	R-29	223	1 5/8	1 7/8	1/8	10
R-08	111	7/16	5/8	3/32	13	R-19	213	15/16	1 3/16	1/8	10	R-30	224	1 3/4	2	1/8	10
R-09	112	1/2	1 1/16	3/32	13	R-20	214	1	1 1/4	1/8	10	R-31	225	1 7/8	2 1/8	1/8	10
R-10	113	9/16	3/4	3/32	13	R-21	215	1 1/16	1 5/16	1/8	10	R-32	226	2	2 1/4	1/8	10
R-11	114	5/8	13/16	3/32	13	R-22	216	1 1/8	1 3/8	1/8	10						

HARDWARE

NITRILE O-RINGS - METRIC

- NBR - nitrile butadiene rubber (BUNA-N 70)
- Rubber resists oil, gas, water, and alcohol solvents

67.444.407



407
PCS

NUMBERS	I/D	SECTION	QTY	NUMBERS	I/D	SECTION	QTY	NUMBERS	I/D	SECTION	QTY
568-006	2.90	1.78	20	568-115	17.13	2.62	13	568-217	29.75	3.53	10
568-008	4.48	1.78	20	568-116	18.72	2.62	13	568-218	31.34	3.53	10
568-010	6.07	1.78	20	568-117	20.29	2.62	13	568-219	32.92	3.53	10
568-011	7.66	1.78	20	568-118	21.89	2.62	13	568-220	34.52	3.53	10
568-012	9.25	1.78	20	568-210	18.64	2.62	13	568-221	36.10	3.53	10
568-014	12.42	1.78	20	568-211	20.22	3.53	10	568-222	37.69	3.53	10
568-110	9.19	2.62	13	568-212	21.82	3.53	10	568-223	40.87	3.53	10
568-111	10.77	2.62	13	568-213	23.40	3.53	10	568-224	44.04	3.53	10
568-112	12.37	2.62	13	568-214	24.99	3.53	10	568-225	47.22	3.53	10
568-113	13.95	2.62	13	568-215	26.58	3.53	10	568-226	50.40	3.53	10
568-114	15.54	2.62	13	568-216	28.17	3.53	10				

HARDWARE

GREASE FITTINGS - SAE

- Clear zinc plated steel / corrosion resistant
- Includes straight, 45° and 90° angled zerk

67.100.110



110
PCS

1/4" - 28 30PC	1/4" - 28 45° 15PC	1/4" - 28 90° 15PC	1/8" - 27 90° 15PC	1/8" - 27 45° 15PC	1/8" - 27 20PC
-------------------	--------------------------	--------------------------	--------------------------	--------------------------	-------------------

HARDWARE

GREASE FITTINGS - METRIC

- Clear zinc plated steel / corrosion resistant
- Includes straight, 45° and 90° angled zerk

67.444.110



110
PCS

M6 x 1 30PC	M6 x 1 45° 15PC	M6 x 1 90° 15PC	M10 x 1.25 90° 15PC	M10 x 1.25 45° 15PC	M10 x 1.25 20PC
----------------	-----------------------	-----------------------	---------------------------	---------------------------	--------------------

ASSORTED KITS

HARDWARE









GREASE FITTINGS - METRIC

- Clear zinc plated steel / corrosion resistant
- Includes straight, 45° and 90° angled zerks

67.444.060

60
PCS



M6 x 1 STRAIGHT  10PC	M6 x 1 45°  5PC	M8 x 1 STRAIGHT  10PC	M8 x 1 90°  5PC	M10 x 1 90°  5PC	M10 x 1 STRAIGHT  10PC
	M6 x 1 90°  5PC	M8 x 1 45°  5PC	M10 x 1 45°  5PC		

HARDWARE

GREASE FITTINGS - SAE

- Clear zinc plated steel / corrosion resistant
- Includes straight, 45° and 90° angled zerks

67.100.100

100
PCS



1/4" - 28 STRAIGHT 25PC	1/4" - 28 STRAIGHT LONG 5PC	1/4" - 28 90° 10PC	1/8" - 27 90° 10PC	1/8" - 27 45° 10PC	1/8" - 28 STRAIGHT 30PC
	1/4" - 28 45° 10PC				

ELECTRICAL





INSULATED RUBBER CLAMPS

- Perfect to organize wire, cable, conduit, pipe & tubing
- Rubber insulation absorbs vibrations & jolts

67.999.042

42
PCS



5/16"	3/8"	1/4"	1/2"	5/8"
				
8PC	6PC	20PC	4PC	4PC

ELECTRICAL



















RUBBER GROMMETS

- Popular variety of EWG & RBG style grommets
- Popular for automotive, electrical and home use

67.999.125

125
PCS



1/8" X 1/4"	1/2" X 19/32"	5/16" X 9/16"	5/8" X 31/32"	3/8"	3/4"
					
15PC	3PC	3PC	3PC	20PC	4PC
7/32" X 5/16"	3/8" X 15/32"	3/8" X 13/16"	3/4" X 15/16"	1/2"	7/8"
					
10PC	6PC	3PC	2PC	10PC	3PC
9/32" X 1/2"	3/8" X 1/2"	7/16" X 3/4"	9/32"	5/8"	1"
					
7PC	5PC	4PC	20PC	5PC	2PC

ELECTRICAL





ELECTRICAL WIRE CONNECTORS - TWIST ON

- Color coded terminals to distinguish gauge size
- Provides secure connection between wires, no tools needed

67.999.158

158
PCS



GREY MIN 2 X #22 MAX 2 X #16	BLUE MIN 2 X #22 MAX 2 X #16	ORANGE MIN 1 X #18 / 1 X #20 MAX 4 X #16 / 1 X #20	YELLOW MIN 2 X #18 MAX 4 X #14 / 1 X #18	RED MIN 2 X #14 MAX 2 X #10 / 1 X #12
				
40PC	40PC	50PC	18PC	10PC

ASSORTED KITS

ELECTRICAL

WIRE TERMINALS AND CONNECTORS

- Large variety of terminal ends and connectors
- Crimp and connect wires from 22 to 10 gauge

67.000.360

360
PCS



16-14GA BULLET MALE CONNECTOR MPD2-156 25PC	16-14GA RING TERMINAL RV52-5 30PC	12-10GA RING TERMINAL RV55-5-5 20PC	22-18GA BUTT CONNECTOR PVT125 30PC	16-14GA SPADE TERMINAL SV52-5 30PC	12-10GA SPADE TERMINAL SV55-5-5 20PC
22-18GA BUTT CONNECTOR BV125 10PC	16-14GA RING TERMINAL 1/4RV2-6 20PC	12-10GA RING TERMINAL 1/4RV5-5-6 15PC	16-14GA BUTT CONNECTOR PVT2 30PC	16-14GA MALE DISCONNECTOR MDD2-250 25PC	22-18GA MALE DISCONNECTOR MDFNY125-250 10PC
16-14GA BULLET FEMALE CONNECTOR FRD2-156 10PC	16-14GA RING TERMINAL 3/8RV2-10 20PC	12-10GA RING TERMINAL 3/8RV5-5-10 15PC	12-10GA BUTT CONNECTOR PVT1.5 15PC	16-14GA FEMALE DISCONNECTOR FDD2-250 25PC	22-18GA FEMALE DISCONNECTOR FDFNY125-250 10PC

ELECTRICAL

WIRE TERMINALS AND CRIMPER

- Large variety of connectors from 22 to 10 gauge
- 3-in-1 crimper tool crimps, cuts and strips wires

67.999.175

175
PCS



22-16GA FEMALE CONNECTOR FDD2-250 12PC	22-16GA RING TERMINAL RV525-3.5 12PC	16-14GA RING TERMINAL RV52-4 12PC	16-14GA SPADE TERMINAL SV2-4 12PC	16-14GA SPADE TERMINAL SV52-3.5 12PC	22-16GA BUTT CONNECTOR BV125 12PC
16-14GA FEMALE CONNECTOR FDD2-250 12PC	22-16GA RING TERMINAL RV125-5 12PC	16-14GA RING TERMINAL RV25-5 12PC	16-14GA SPADE TERMINAL SV525-5 12PC	22-16GA SPADE TERMINAL SV125-3.5 12PC	16-14GA BUTT CONNECTOR BV2 12PC
12-10GA FEMALE CONNECTOR FDD5.5-250 5PC	12-10GA RING TERMINAL RV5.5-5 5PC	12-10GA RING TERMINAL RV5.5-6 5PC	12-10GA RING TERMINAL RV5.5-8 5PC	12-10GA SPADE TERMINAL FDD2-250 5PC	12-10GA BUTT CONNECTOR FDD2-250 5PC

CRIMPING TOOL

ELECTRICAL

BLACK HEAT SHRINK TUBES

- Tubes shrink up to half their original size when heated
- Repairs, seals, insulates and adds strength to wire

67.999.127

127
PCS



2.0 x 40MM 30PC	3.5 x 40MM 20PC	5.0 x 40MM 20PC	7.0 x 80MM 16PC	10.0 x 80MM 8PC	13.0 x 85MM 8PC
2.5 x 40MM 25PC					

ELECTRICAL

ALLIGATOR AND CHARGING CLIPS

- Red or black pvc grips for insulation and easy identification
- Clear zinc plated finish for corrosion resistance

67.999.060

60
PCS



MINI ALLIGATOR CLIPS PINCES CROCODILES 20PC	1-3/4" ALLIGATOR CLIPS PINCES CROCODILES 16PC	30AMP CHARGING CLIPS PINCES DE CHARGEMENT 2PC	15AMP CHARGING CLIPS PINCES DE CHARGEMENT 2PC	2" ALLIGATOR CLIPS PINCES CROCODILES 12PC	5AMP CHARGING CLIPS PINCES DE CHARGEMENT 8PC
--	--	--	--	--	---

ELECTRICAL

AUTOMOTIVE FUSES - ATM

- Large variety of most popular ATM "mini" auto fuses
- Color coded to industry standard for easy identification

67.998.120

120
PCS



5 AMP ORANGE 20PC	10 AMP RED 20PC	15 AMP BLUE 20PC	20 AMP YELLOW 20PC	25 AMP CLEAR 20PC	30 AMP GREEN 20PC
-----------------------------	---------------------------	----------------------------	------------------------------	-----------------------------	-----------------------------

ASSORTED KITS

ELECTRICAL

AUTOMOTIVE FUSES - ATO

- Large variety of most popular ATO standard auto fuses
- Color coded to industry standard for easy identification

67.999.120



5 AMP	10 AMP	15 AMP	20 AMP	25 AMP	30 AMP
ORANGE	RED	BLUE	YELLOW	CLEAR	GREEN
20PC	20PC	20PC	20PC	20PC	20PC

120
PCS

ELECTRICAL

AUTOMOTIVE FUSES - ATX

- Large variety of most popular ATX "maxi" auto fuses
- Color coded to industry standard for easy identification

67.999.024



20 AMP	30 AMP	40 AMP	50 AMP	60 AMP	70 AMP
YELLOW	GREEN	ORANGE	RED	BLUE	BROWN
4PC	4PC	4PC	4PC	4PC	4PC

24
PCS

ELECTRICAL

AUTOMOTIVE FUSES - ATO/MINI

- Variety of most popular ATO and ATM auto fuses
- Color coded to industry standard for easy identification

67.999.080



5 AMP ATO ORANGE	10 AMP ATO RED	15 AMP ATO BLUE	20 AMP ATO YELLOW	25 AMP ATO WHITE	30 AMP ATO GREEN
5PC	10PC	5PC	10PC	5PC	10PC
5 AMP ATM ORANGE	10 AMP ATM RED	15 AMP ATM BLUE	20 AMP ATM YELLOW	25 AMP ATM WHITE	30 AMP ATM GREEN
5PC	5PC	5PC	10PC	5PC	5PC

80
PCS

ELECTRICAL

AUTOMOTIVE FUSES - ATO/MINI/MAXI/BOSCH

- Large variety of ATO, ATM, ATX and Bosch fuses
- Color coded to industry standard for easy identification

67.999.147



5 AMP ATM ORANGE	15 AMP ATM BLUE	5 AMP ATO ORANGE	15 AMP ATO BLUE	2 AMP BLACK	
10PC	10PC	5PC	10PC	5 AMP 2PC	
7.5 AMP ATM BROWN	20 AMP ATM YELLOW	7.5 AMP ATO BROWN	20 AMP ATO YELLOW	8 AMP BLACK 2PC	
10PC	10PC	10PC	10PC	16 AMP RED 5PC	30 AMP ATX GREEN 2PC
10 AMP ATM RED	30 AMP ATM GREEN	10 AMP ATO RED	25 AMP ATO CLEAR 30 AMP ATO GREEN	25 AMP BLUE 5PC	40 AMP ATX ORANGE 2PC
10PC	10PC	10PC	2 X 5PC	40 AMP WHITE 5PC	60 AMP ATX BLUE 2PC
					70 AMP ATX BROWN 2PC

147
PCS

ELECTRICAL

AUTOMOTIVE FUSES - GLASS TUBE

- Large variety of popular and hard to find fuses
- Comes with tool to safely remove/install fuse

67.999.121



5A	10A	15A	20A	25A	30A
20PC	20PC	20PC	20PC	20PC	20PC
1PC - FUSE PULLER					

121
PCS

ASSORTED KITS

ELECTRICAL

AUTOMOTIVE BULBS - 12V

- Variety of stop, tail, turn, cluster and interior bulbs
- Easy identification by industry standard codes

67.999.017



**17
PCS**

#53 3PC	#67 1PC	#1003 1PC	#1141 1PC	#1157 1PC	#2057 1PC
#57 2PC					
#194 2PC	#67 1PC	#1073 1PC	#1034 1PC	#1157 1PC	#2057 1PC

FARM PINS

CLEVIS PINS - SAE

14 SIZES
67.700.312



**23
PCS**

FARM PINS

**COTTER PINS - METRIC
SMALL/8 SIZES**

67.700.302



**215
PCS**

FARM PINS

**COTTER PINS - METRIC
LARGE/10 SIZES**

67.700.303



**40
PCS**

FARM PINS

HAIR PINS - SAE

6 SIZES
67.700.305



**28
PCS**

HARDWARE

**EXTERNAL E-CLIPS - METRIC
7 SIZES**

67.700.309



**70
PCS**

HARDWARE

**INTERNAL SNAP RINGS - METRIC
6 SIZES**

67.700.310



**55
PCS**

HARDWARE

**EXTERNAL SNAP RINGS - METRIC
13 SIZES**

67.700.311



**70
PCS**

HARDWARE

**ROLL PINS - METRIC
13 SIZES**

67.700.307



**62
PCS**

HARDWARE

**HEX HEAD SET SCREWS - SAE
8 SIZES**

67.700.306



**65
PCS**

HARDWARE

**WOODRUFF KEYS - METRIC
8 SIZES**

67.700.308



**40
PCS**

HARDWARE

**KEYSTOCK - SAE
5 SIZES**

67.700.313



**30
PCS**

HARDWARE

**MACHINE BUSHINGS - SAE
4 SIZES**

67.983.906



**20
PCS**

ASSORTED KITS

HARDWARE

GREASE FITTINGS - SAE
6 SIZES
67.700.304



40
PCS

HARDWARE

GREASE FITTINGS - METRIC
7 SIZES
67.700.314



50
PCS

HARDWARE

GREASE FITTINGS - DRIVE IN
4 SIZES
67.700.315



50
PCS

ELECTRICAL

AUTOMOTIVE FUSES - ATO
5 SIZES
67.700.300



50
PCS

ELECTRICAL

AUTOMOTIVE FUSES - ATM
5 SIZES
67.700.301



50
PCS

COTTER PIN KIT
68.000.050



50
PCS

COTTER PIN KIT
68.000.100



100
PCS

NYLON LOCK NUTS
67.700.070



70
PCS

UNIVERSAL BATTERY TERMINAL
ZINC, 2 PACK
67.999.005

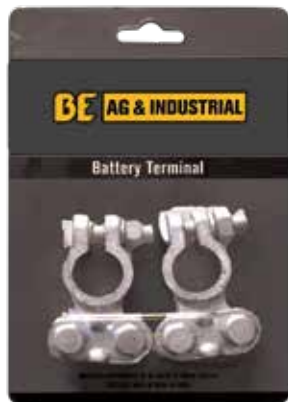

UNIVERSAL BATTERY TERMINAL
LEAD, 2 PACK
67.999.006

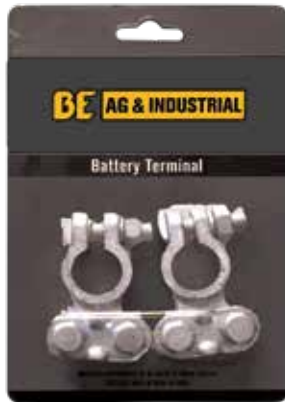

HD POLYMER HARDWARE CASE
85.600.103

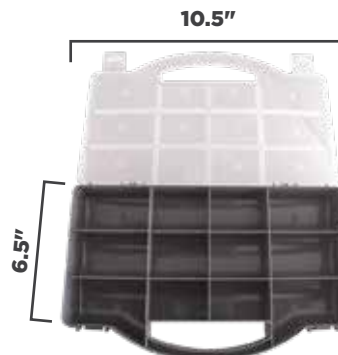

ALL BE LED LIGHTS SHARE THE SAME GREAT QUALITY, BUILD & COMPONENTS.



CAN BE USED ANYWHERE, ANYTIME
WORKING TEMP: -45°F TO 130°F

DIECAST ALUMINUM HOUSING
INCREASED DURABILITY & HEAT REDUCTION

LIFESPAN: 50,000 HOURS
LONG LASTING INVESTMENT

POLYCARBONATE LENS
HIGH IMPACT RESISTANT

LOW AMP DRAW
CREATING LOW VEHICLE
DEMAND

IP 67 WEATHER RATING
SEALED AGAINST DUST & WATER

LIGHT COLOR: 6000°K WHITE
PROVIDES A NATURAL LIGHT

MOUNTING BRACKETS
MAKES INSTALLATION EASY



**INNOVATIVE RETAIL PACKAGING
WITH BUILT-IN WINDOW TO VIEW
PRODUCT AND HANG TABS
FOR EASY DISPLAY**





HOUSING WITHOUT HARDWARE

FLOOD LIGHT - 6 EPICSTAR LEDS

LF1801

18W **1200 LUMENS**

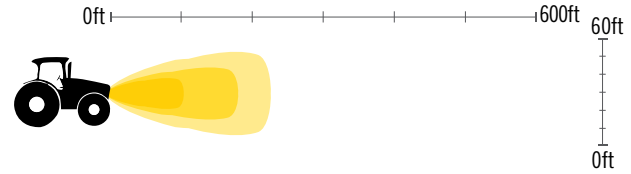

HOUSING WITHOUT HARDWARE

FLOOD LIGHT - 6 CREE LEDS

LF1803

18W **2160 LUMENS**

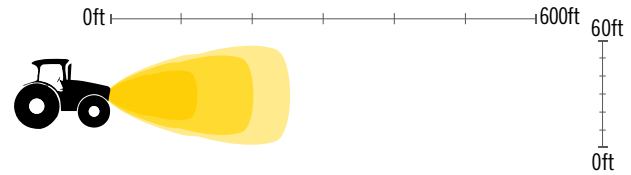

HOUSING WITHOUT HARDWARE

FLOOD LIGHT - 14 EPICSTAR LEDS

LF4201

42W **3000 LUMENS**

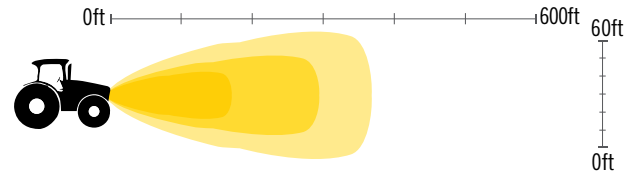

HOUSING WITHOUT HARDWARE

FLOOD LIGHT - 16 EPICSTAR LEDS

LF4801

48W **3300 LUMENS**

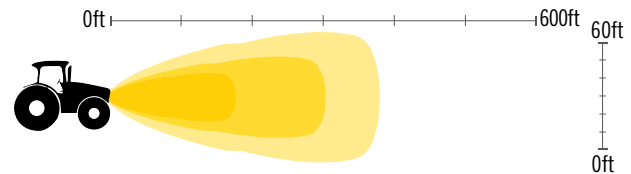

LED WORK LIGHTS

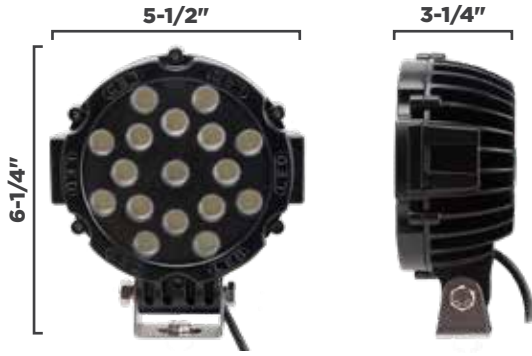

HOUSING WITHOUT HARDWARE

FLOOD LIGHT - 17 EPISTAR LEDS
LF5101

51W **3825 LUMENS**

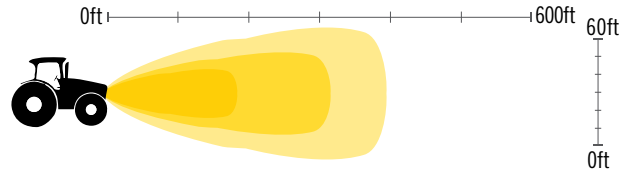

HOUSING WITHOUT HARDWARE

PORTABLE FLOOD LIGHT - 5 EPISTAR LEDS
LF1501

15W **1125 LUMENS**

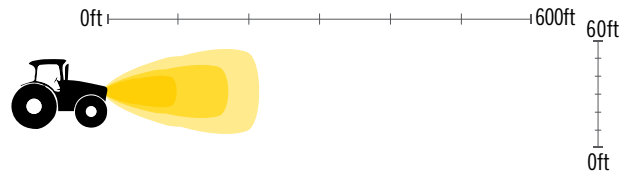

HOUSING WITHOUT HARDWARE

FLOOD LIGHT - 6 EPISTAR LEDS
LF1802

18W **1350 LUMENS**

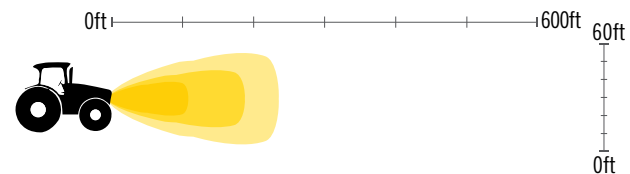



HOUSING WITHOUT HARDWARE

SPOT LIGHT - 9 EPISTAR LEDS

LS2701

27W

1755 LUMENS

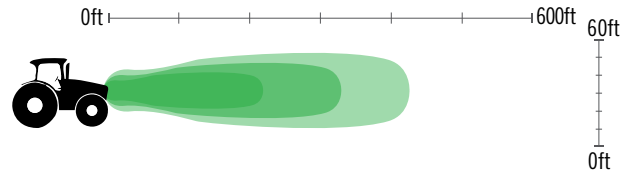

COMBO FLOOD/SPOT LIGHT BAR - 22"

LB22120

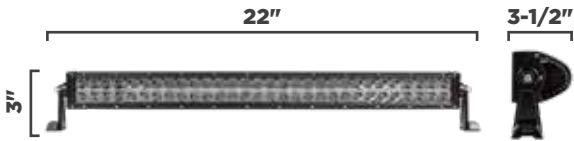

HOUSING WITHOUT HARDWARE

120W

9600 LUMENS

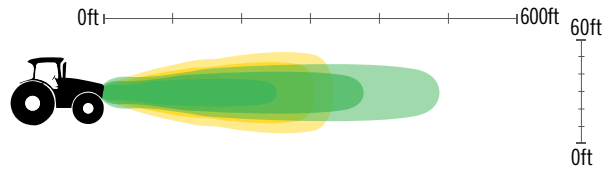

COMBO FLOOD/SPOT LIGHT BAR - 32"

LB32180

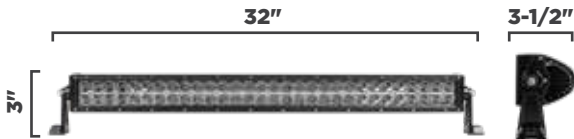

HOUSING WITHOUT HARDWARE

180W

14400 LUMENS

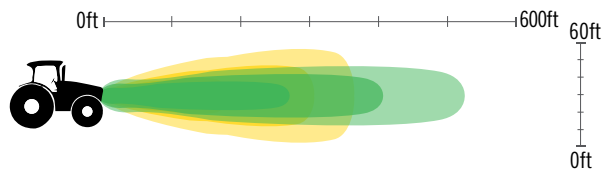

LED LIGHT BARS

COMBO FLOOD/SPOT LIGHT BAR - 42"

LB42240

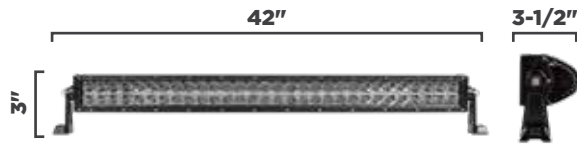

HOUSING WITHOUT HARDWARE

240W **19200 LUMENS**

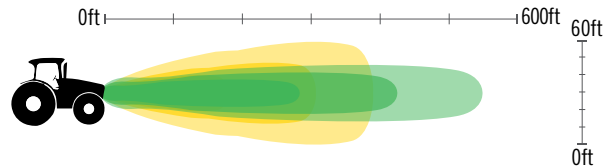

COMBO FLOOD/SPOT LIGHT BAR - 50"

LB50288

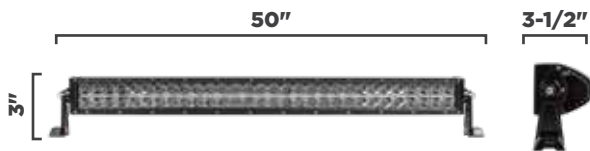

HOUSING WITHOUT HARDWARE

288W **23040 LUMENS**

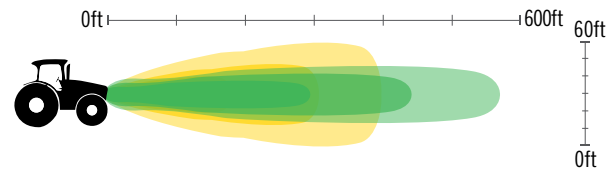

COMBO FLOOD/SPOT LIGHT BAR - 52" CURVED

LB52300

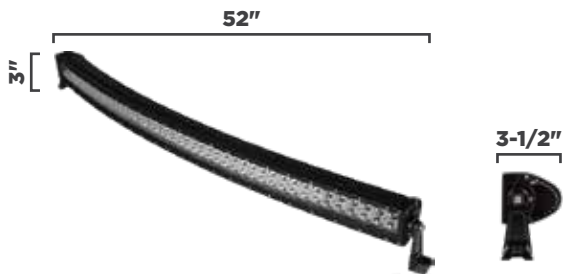

HOUSING WITHOUT HARDWARE

300W **28800 LUMENS**

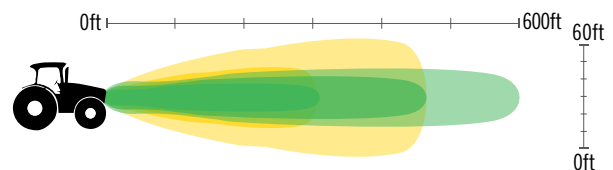

LED LIGHT WIRING HARNESS

LEDWH01

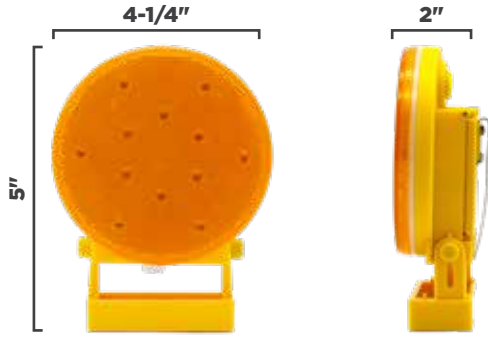

- 16.4' wiring harness
- 2 Sets of DT connections
- 30A relay/up to 360W
- Plug and play - easy installation of any BE LED lights

**HOUSING WITHOUT HARDWARE****PORTABLE SAFETY LIGHT
BATTERY OPERATED
LS001**

- Push button operation
- 3 User-selectable flash patterns
- Magnetic base and 180° adjustable
- 72 hours of operation on 2 x AA batteries (not included)

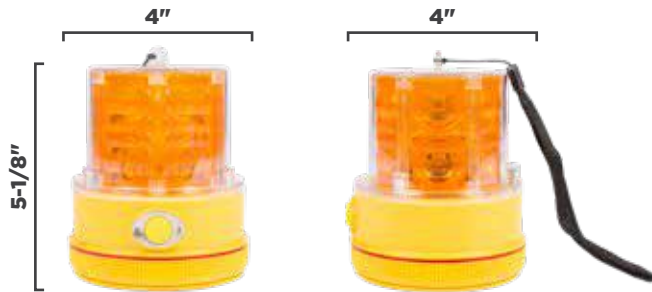
**HOUSING WITHOUT HARDWARE****360° SAFETY LIGHT
BATTERY OPERATED
LS002**

- 24 Ultra-bright LEDs
- Magnetic base
- 60 Triple flashes per minute
- 300-400 hours of operation on 2 x D batteries (not included)

**HOUSING WITHOUT HARDWARE****LED SAFETY LIGHT
12V
LS003**

- 36W, 1800 Lumens
- Connects to a 12V car outlet
- Magnetic base
- 50,000 hours life time

**HOUSING WITHOUT HARDWARE****360° BEACON LIGHT
HIGH PIPE MOUNT
BL01**

- DC 12-24V
- Meets IP56 protection standards
- -30°C to + 50°C temperature range
- 80 SMD5050 360° revolving flash / intermittent flash

BEACON LIGHTS & TOWING LIGHT KITS



HOUSING WITHOUT HARDWARE

360° BEACON LIGHT LOW PIPE MOUNT BL02

- DC 12-24V
- Meets IP56 protection standards
- -30°C to + 50°C temperature range
- 80 SMD5050 360° revolving flash / intermittent flash

BRACKETS FOR BEACON LIGHTS

- Copper and rubber
- Fits any BE Beacon Lights

SIDE MOUNT BLB901



TOP MOUNT BLB902



TOP FLUSH BLB903



SIDE L-SHAPED BLB904



HOUSING WITHOUT HARDWARE

12V LED TOWING LIGHT KIT LT1230

- 24 LEDs (12 on each side)
- 30' wiring harness included
- Magnetic base
- 100,000 hours life time



12V COMMERCIAL GRADE LED TOWING LIGHT KIT LTHD1230

- Carrying case included
- 30' wiring harness included
- 7' span between two lights
- 60 lb round pull magnets



12V SUBMERSIBLE LED TRAILER LIGHT KIT LST1222

- 22' wiring harness included
- For trailers under 80" wide
- Mounting hardware & license plate bracket
- DOT certified



HITCH & LINKAGE PLAN-O-GRAM

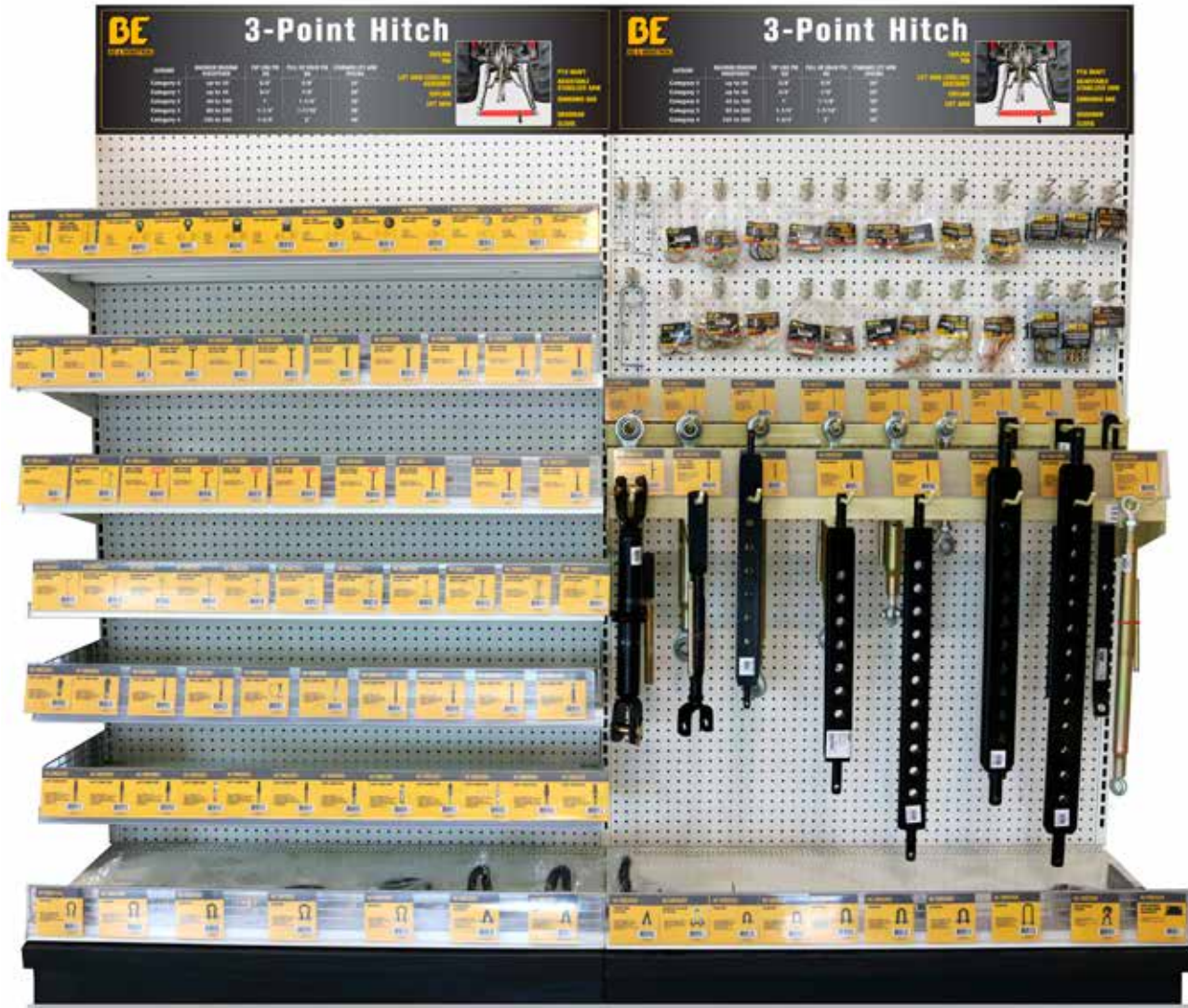

**DESIGNED TO WORK WITH
STANDARD LOZIER SHELVING UNITS**

**INFORMATIVE POP MATERIAL
SIMPLIFIES AND MAKES PROGRAM CONSUMER FRIENDLY**

**CONTACT US TODAY FOR INFORMATION AND PRICING ON OUR HITCH & LINKAGE PROGRAM.
RECEIVE THE MERCHANDISERS FREE WITH THE PURCHASE OF THE COMPLETE PROGRAM.**

FORGED HEAD & ZINC PLATED FIXED HANDLE HITCH PINS

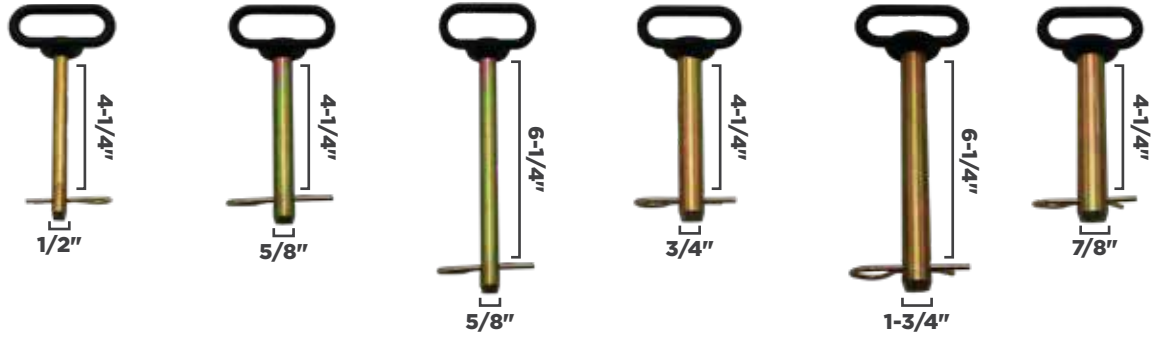

PART#	705HPF	702HPF	704HPF	703HPF	700HPF	709HPF
PIN DIAMETER	1/2"	5/8"	5/8"	3/4"	3/4"	7/8"
USABLE LENGTH	4-1/4"	4-1/4"	6-1/4"	4-1/4"	6-1/4"	4-1/4"
OVERALL LENGTH	5-1/4"	5-1/4"	7-1/4"	5-1/2"	7-1/4"	5-1/4"
UNIT WEIGHT (LBS)	0.4	0.55	0.8	0.75	1	1
ORDER MULTIPLES	5	5	5	5	5	5

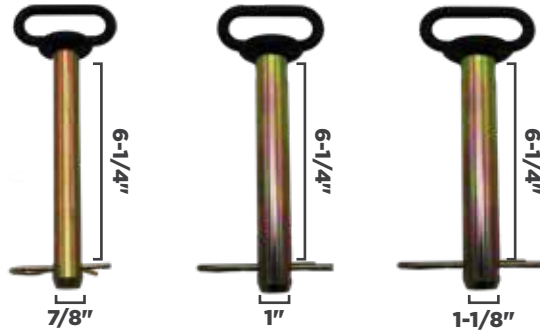

PART#	701HPF	706HPF	707HPF
PIN DIAMETER	7/8"	1"	1-1/8"
USABLE LENGTH	6-1/4"	6-1/4"	6-1/4"
OVERALL LENGTH	7-1/4"	7-1/4"	7-1/4"
UNIT WEIGHT (LBS)	1.4	1.8	2.2
ORDER MULTIPLES	5	5	1

*ITEMS ARE SOLD ONLY IN THE ORDER MULTIPLES LISTED

HEAT TREATED EN 15 HIGH STRENGTH STEEL RED HEAD HITCH PINS

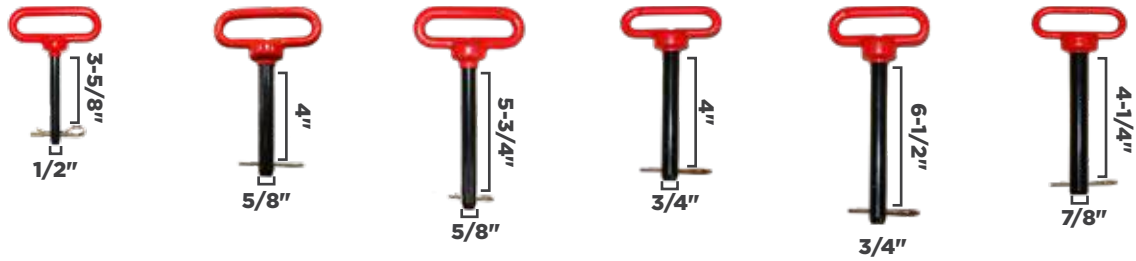

PART#	705HPR	702HPR	704HPR	703HPR	700HPR	709HPR
PIN DIAMETER	1/2"	5/8"	5/8"	3/4"	3/4"	7/8"
USABLE LENGTH	3-5/8"	4"	5-3/4"	4"	6-1/2"	4-1/4"
OVERALL LENGTH	6-5/8"	7"	9"	7"	9-1/2"	7-1/4"
UNIT WEIGHT (LBS)	0.5	0.75	0.95	1.35	1.35	1.4
ORDER MULTIPLES	5	5	5	5	5	5



PART#	701HPR	714HPR	706HPR	712HPR	707HPR	708HPR
PIN DIAMETER	7/8"	1"	1"	1"	1-1/8"	1-1/4"
USABLE LENGTH	6-1/2"	4-3/4"	7-1/2"	12"	8-1/2"	8-1/2"
OVERALL LENGTH	9-1/2"	7-3/4"	10"	15"	11-1/2"	11-1/2"
UNIT WEIGHT (LBS)	1.75	1.8	2.45	3.35	3.3	3.95
ORDER MULTIPLES	5	5	5	5	1	1

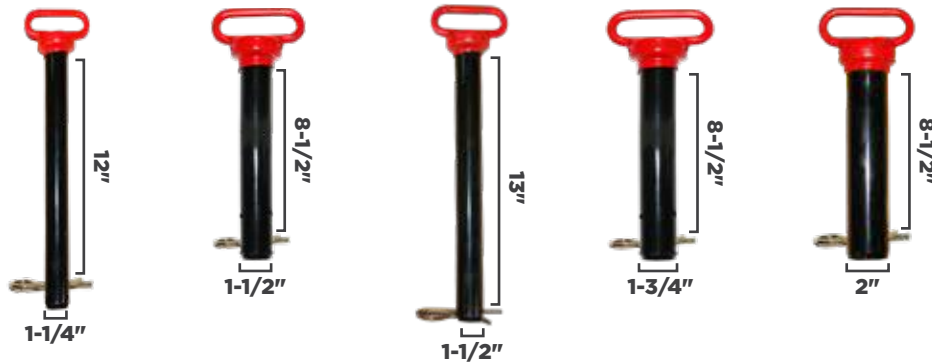

PART#	713HPR	719HPR	717HPR	731HPR	732HPR
PIN DIAMETER	1-1/4"	1-1/2"	1-1/2"	1-3/4"	2"
USABLE LENGTH	12"	8-1/2"	13"	8-1/2"	8-1/2"
OVERALL LENGTH	15"	11-1/2"	16"	12"	12"
UNIT WEIGHT (LBS)	5.25	5.5	7.75	7.5	9.65
ORDER MULTIPLES	1	1	1	1	1

*ITEMS ARE SOLD ONLY IN THE ORDER MULTIPLES LISTED

HEAT TREATED EN 19 HIGH STRENGTH STEEL BLUE HEAD HITCH PINS

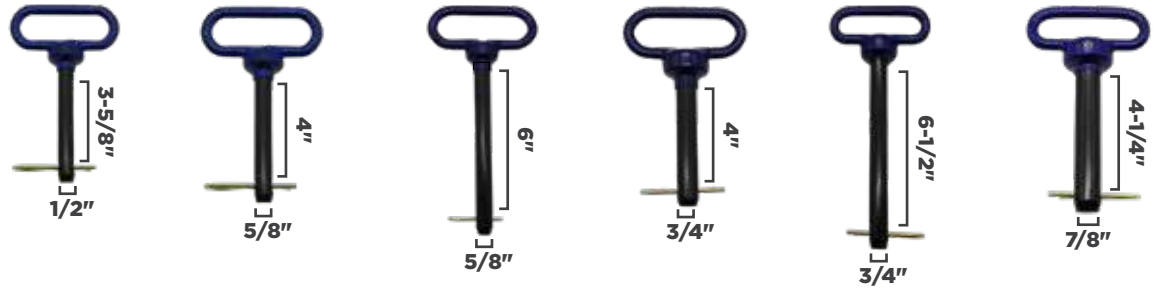

PART#	705HPBLU	702HPBLU	704HPBLU	703HPBLU	700HPBLU	709HPBLU
PIN DIAMETER	1/2"	5/8"	5/8"	3/4"	3/4"	7/8"
USABLE LENGTH	3-5/8"	4"	6"	4"	6-1/2"	4-1/4"
OVERALL LENGTH	6-5/8"	7"	9"	7"	9-1/2"	7-1/4"
UNIT WEIGHT (LBS)	0.55	0.75	0.9	0.95	1.35	1.35
ORDER MULTIPLES	5	5	5	5	5	5



PART#	701HPBLU	714HPBLU	706HPBLU	707HPBLU	708HPBLU	719HPBLU
PIN DIAMETER	7/8"	1"	1"	1-1/8"	1-1/4"	1-1/2"
USABLE LENGTH	6-1/2"	4-3/4"	7"	7"	7"	8-1/2"
OVERALL LENGTH	9-1/2"	7-3/4"	10"	10"	10"	11-1/2"
UNIT WEIGHT (LBS)	1.75	1.85	2.35	3.4	3.85	5.55
ORDER MULTIPLES	5	5	5	1	1	1

*ITEMS ARE SOLD ONLY IN THE ORDER MULTIPLES LISTED

GRADE 5 DROP FORGED HITCH PINS

FIXED HANDLE

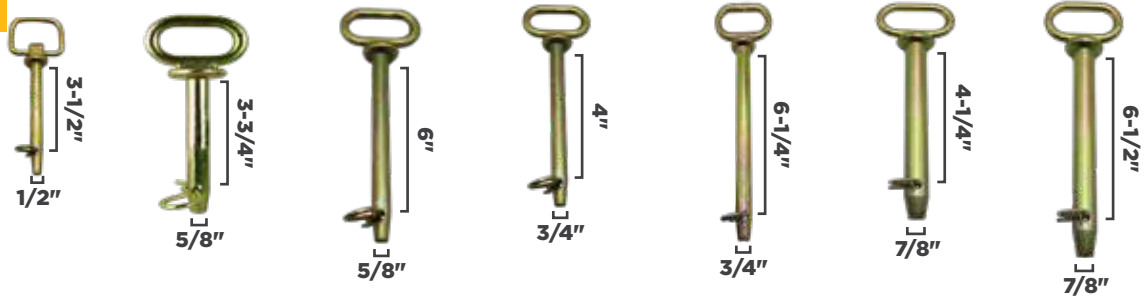

PART#	705FFHP	702FFHP	704FFHP	703FFHP	700FFHP	709FFHP	701FFHP
PIN DIAMETER	1/2"	5/8"	5/8"	3/4"	3/4"	7/8"	7/8"
USABLE LENGTH	3-1/2"	3-3/4"	6"	4"	6-1/4"	4-1/4"	6-1/2"
OVERALL LENGTH	5-11/32"	6-5/16"	9-3/16"	7-7/16"	9-7/16"	7-3/4"	10-11/16"
HANDLE	WIRE	SOLID	SOLID	SOLID	SOLID	SOLID	SOLID
UNIT WEIGHT (LBS)	0.4	0.6	0.95	1	1.2	1.2	1.85
ORDER MULTIPLES	5	5	5	5	5	5	5



PART#	714FFHP	706FFHP	707FFHP	708FFHP	716FFHP	719FFHP
PIN DIAMETER	1"	1"	1-1/8"	1-1/4"	1-3/8"	1-1/2"
USABLE LENGTH	4-3/4"	6-3/4"	7"	7"	7"	8"
OVERALL LENGTH	8-17/32"	10-17/32"	11"	11-1/8"	11-27/32"	12-23/32"
HANDLE	SOLID	SOLID	SOLID	SOLID	SOLID	SOLID
UNIT WEIGHT (LBS)	1.75	2.2	2.85	3.5	4.6	5.7
ORDER MULTIPLES	5	5	1	1	1	1

ORANGE FOLD OVER HANDLE



PART#	705FHP	700FHP	701FHP	706FHP	708FHP
PIN DIAMETER	1/2"	3/4"	7/8"	1"	1-1/4"
USABLE LENGTH	3-1/2"	6-1/4"	6-1/2"	6-3/4"	7"
OVERALL LENGTH	6-1/4"	9-1/4"	9-1/2"	9-3/4"	11-3/16"
UNIT WEIGHT (LBS)	0.45	1.2	1.55	2.1	3.15
ORDER MULTIPLES	5	5	5	5	1

*ITEMS ARE SOLD ONLY IN THE ORDER MULTIPLES LISTED

FORGED HEAD & ZINC PLATED SWIVEL HANDLE HITCH PINS

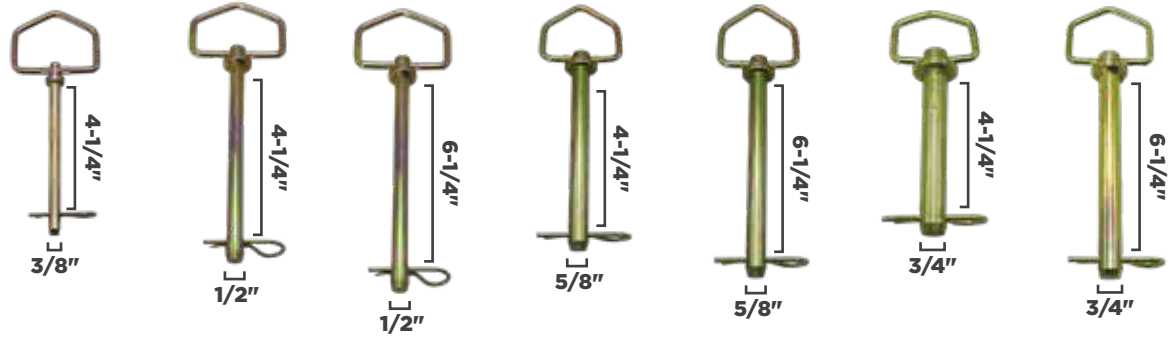

PART#	715HPC	705HPC	712HPC	702HPC	704HPC	703HPC	700HPC
PIN DIAMETER	3/8"	1/2"	1/2"	5/8"	5/8"	3/4"	3/4"
USABLE LENGTH	4-1/4"	4-1/4"	6-1/4"	4-1/4"	6-1/4"	4-1/4"	6-1/4"
OVERALL LENGTH	5-1/2"	5-3/4"	7-3/4"	5-3/4"	7-3/4"	5-3/4"	7-3/4"
UNIT WEIGHT (LBS)	0.3	0.4	0.55	0.6	0.85	0.85	1.15
ORDER MULTIPLES	5	5	5	5	5	5	5

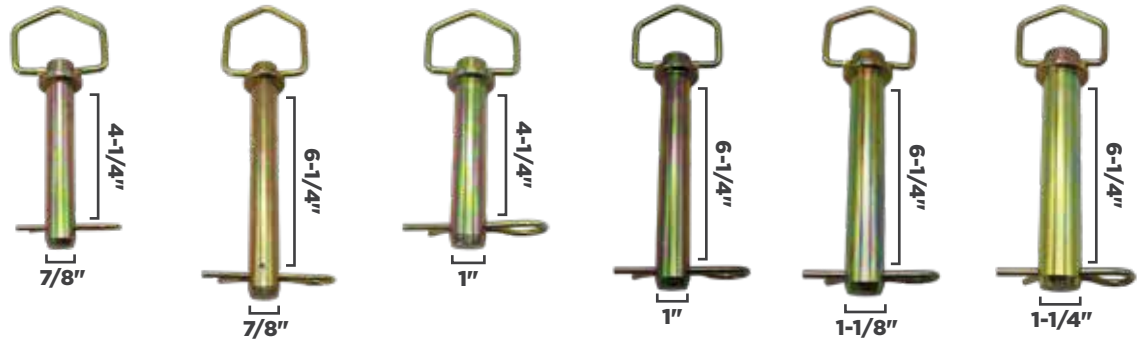

PART#	709HPC	701HPC	714HPC	706HPC	707HPC	708HPC
PIN DIAMETER	7/8"	7/8"	1"	1"	1-1/8"	1-1/4"
USABLE LENGTH	4-1/4"	6-1/4"	4-1/4"	6-1/4"	6-1/4"	6-1/4"
OVERALL LENGTH	5-3/4"	7-3/4"	5-3/4"	7-3/4"	7-3/4"	7-3/4"
UNIT WEIGHT (LBS)	1.15	1.5	1.5	1.9	2.4	2.95
ORDER MULTIPLES	5	5	5	5	1	1

*ITEMS ARE SOLD ONLY IN THE ORDER MULTIPLES LISTED

FORGED HEAD & ZINC PLATED HITCH PINS WITH CHAIN

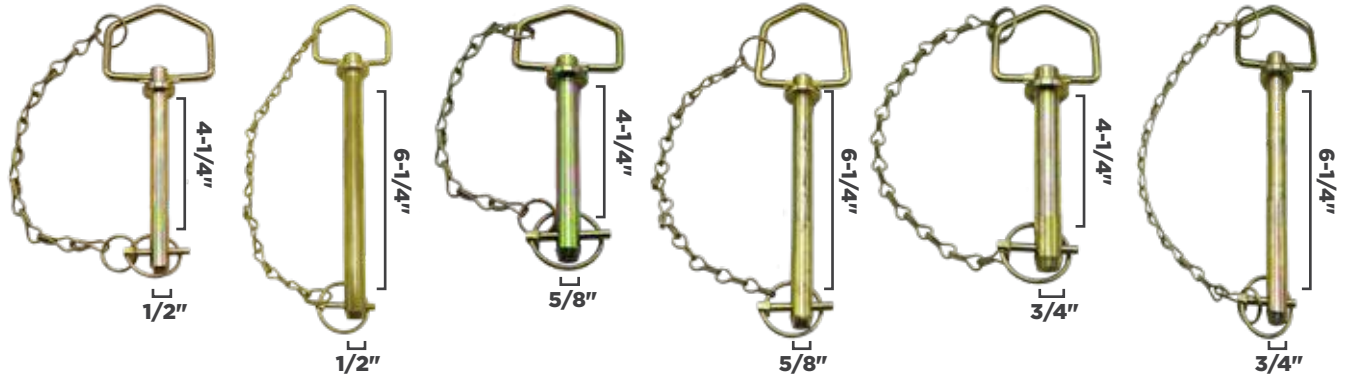

PART#	705HP	712HP	702HP	704HP	703HP	700HP
PIN DIAMETER	1/2"	1/2"	5/8"	5/8"	3/4"	3/4"
USABLE LENGTH	4-1/4"	6-1/4"	4-1/4"	6-1/4"	4-1/4"	6-1/4"
OVERALL LENGTH	5-3/4"	7-3/4"	5-3/4"	7-3/4"	5-3/4"	7-3/4"
UNIT WEIGHT (LBS)	0.5	0.6	0.75	0.9	0.95	1.2
ORDER MULTIPLES	5	5	5	5	5	5

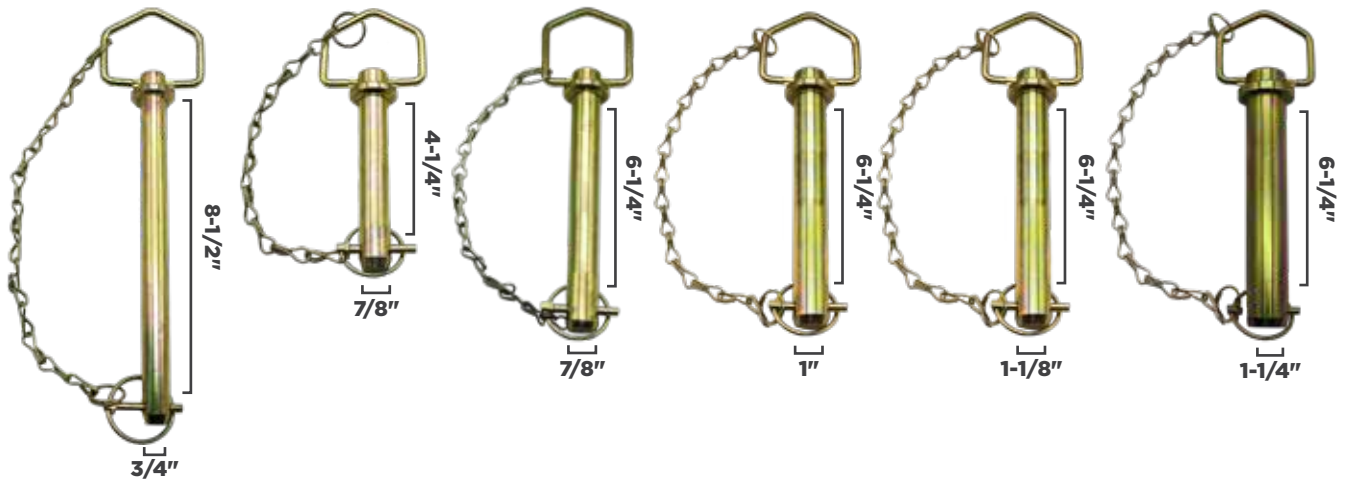

PART#	730HP	709HP	701HP	706HP	707HP	708HP
PIN DIAMETER	3/4"	7/8"	7/8"	1"	1-1/8"	1-1/4"
USABLE LENGTH	8-1/2"	4-1/4"	6-1/4"	6-1/4"	6-1/4"	6-1/4"
OVERALL LENGTH	10"	5-3/4"	7-3/4"	7-3/4"	7-3/4"	7-3/4"
UNIT WEIGHT (LBS)	1.45	1.2	1.55	1.95	2.5	3
ORDER MULTIPLES	5	5	5	5	1	1

*ITEMS ARE SOLD ONLY IN THE ORDER MULTIPLES LISTED

ZINC PLATED BENT HITCH PINS & SAFETY LOCK PINS



PART#	725HP	723HP	720HPS	720HP	720HPL	720HPXL
PIN DIAMETER	5/16"	3/8"	1/2"	1/2"	1/2"	1/2"
USABLE LENGTH	3"	3"	2-1/2"	3"	4"	5"
HAIR PIN	P-7923	P-7923	P-7924	P-7924	P-7924	P-7924
UNIT WEIGHT (LBS)	0.15	0.2	0.35	0.35	0.4	0.5
ORDER MULTIPLES	5	5	5	5	5	5



PART#	722HP	722HPL	722HPEL	722HPXL	721HP	721HPXL
PIN DIAMETER	5/8"	5/8"	5/8"	5/8"	3/4"	3/4"
USABLE LENGTH	3"	3-1/2"	4"	5"	3-1/2"	4-1/2"
HAIR PIN	P-7924	P-7924	P-7924	P-7924	P-7924	P-7924
UNIT WEIGHT (LBS)	0.6	0.55	0.7	0.76	0.9	1.05
ORDER MULTIPLES	5	5	5	5	5	5

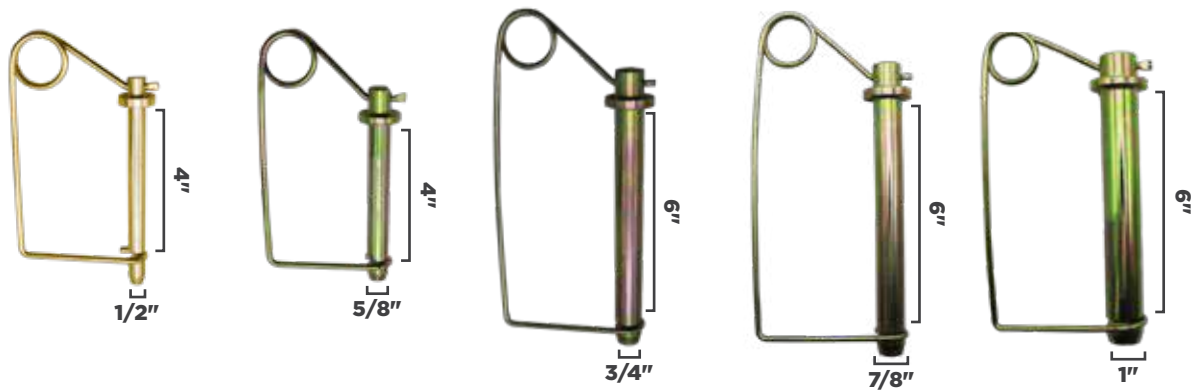

PART#	710HPW	711HPW	700HPW	701HPW	706HPW
PIN DIAMETER	1/2"	5/8"	3/4"	7/8"	1"
USABLE LENGTH	4"	4"	6"	6"	6"
OVERALL LENGTH	5-1/2"	5-1/2"	7-1/2"	7-1/2"	7-1/2"
UNIT WEIGHT (LBS)	0.5	0.65	1.1	1.5	1.85
ORDER MULTIPLES	5	5	5	5	5

*ITEMS ARE SOLD ONLY IN THE ORDER MULTIPLES LISTED

ZINC PLATED CLEVIS PINS

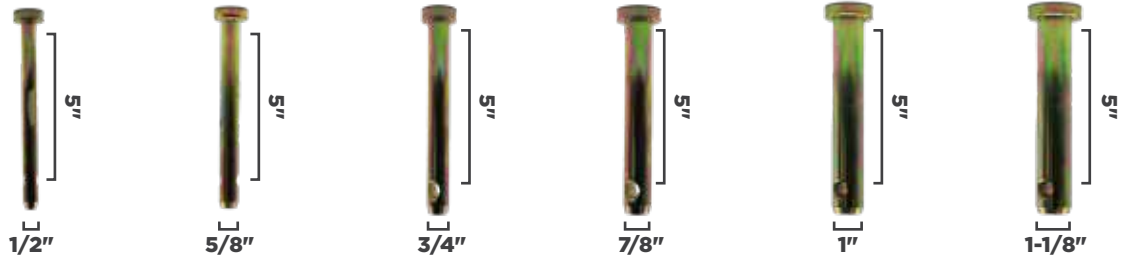

PART#	6036	6037	6038	6039	6040	6041
PIN DIAMETER	1/2"	5/8"	3/4"	7/8"	1"	1-1/8"
USABLE LENGTH	5"	5"	5"	5"	5"	5"
OVERALL LENGTH	6-3/8"	6-3/8"	6-3/8"	6-3/8"	6-3/8"	6-3/8"
UNIT WEIGHT (LBS)	0.4	0.6		1.10	1.45	1.7
ORDER MULTIPLES	5	5	5	5	5	1

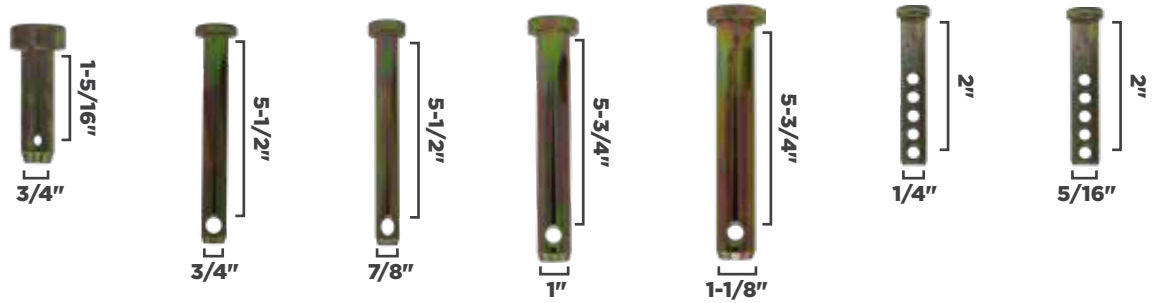

PART#	6042	6043	6044	6045	6046	6047	6048
PIN DIAMETER	3/4"	3/4"	7/8"	1"	1-1/8"	1/4"	5/16"
USABLE LENGTH	1-5/16"	5-1/2"	5-1/2"	5-3/4"	5-3/4"	2"	2"
OVERALL LENGTH	2-5/16"	6-5/8"	6-5/8"	7-1/8"	7-1/8"	2-3/16"	2-3/16"
UNIT WEIGHT (LBS)							
ORDER MULTIPLES	5	5	5	5	1	4	4

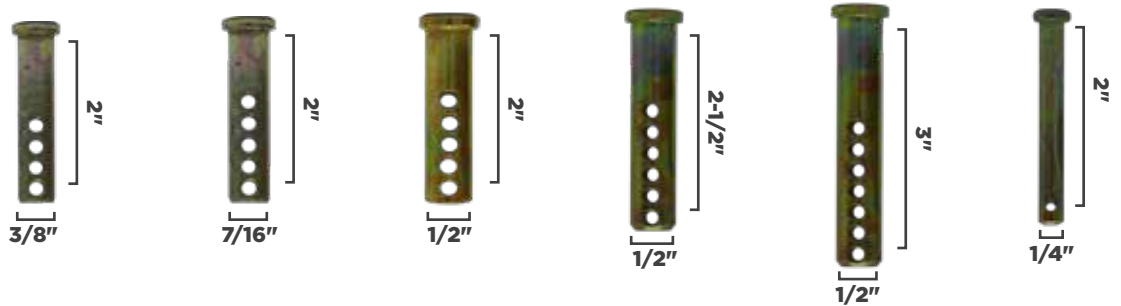

PART#	6049	6050	6051	6052	6053	6054
PIN DIAMETER	3/8"	7/16"	1/2"	1/2"	1/2"	1/4"
USABLE LENGTH	2"	2"	2"	2-1/2"	3"	2"
OVERALL LENGTH	2-3/16"	2-3/16"	2-3/16"	2-11/16"	3-3/16"	2-3/8"
UNIT WEIGHT (LBS)						
ORDER MULTIPLES	2	2	2	2	2	10

*ITEMS ARE SOLD ONLY IN THE ORDER MULTIPLES LISTED

GRADE 5 / EN8 DOUBLE LOCK HITCH PINS WITH QUICK RELEASE HANDLE



DOUBLE LOCKING MECHANISM

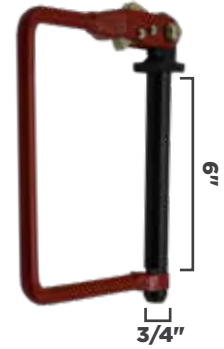

PART#	702HPDL	703HPDL	700HPDL
PIN DIAMETER	5/8"	3/4"	3/4"
USABLE LENGTH	4-1/2"	4-1/2"	6"
UNIT WEIGHT (LBS)	2.1	2.25	2.6
ORDER MULTIPLES	5	5	5

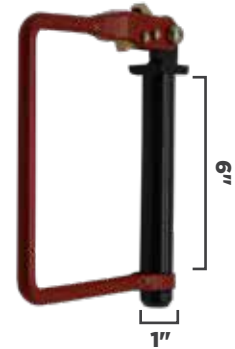

PART#	709HPDL	701HPDL	706HPDL
PIN DIAMETER	7/8"	7/8"	1"
USABLE LENGTH	4-1/2"	6"	6"
UNIT WEIGHT (LBS)	2.6	2.95	3.25
ORDER MULTIPLES	5	5	5

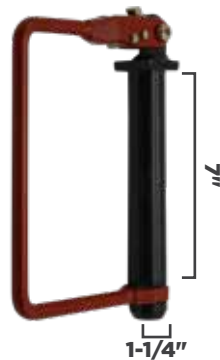
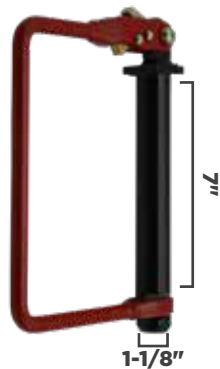

PART#	707HPDL	708HPDL	719HPDL
PIN DIAMETER	1-1/8"	1-1/4"	1-1/2"
USABLE LENGTH	7"	7"	8"
UNIT WEIGHT (LBS)	4.05	4.7	6.45
ORDER MULTIPLES	1	1	1

*ITEMS ARE SOLD ONLY IN THE ORDER MULTIPLES LISTED

FORGED YELLOW ZINC DICHROMATE LIFT ARM PINS

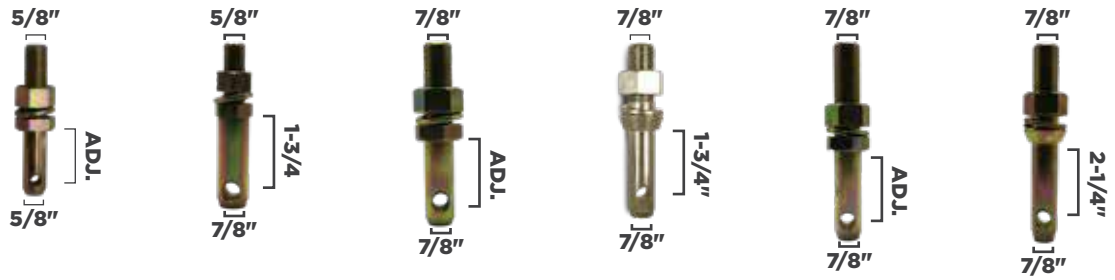

PART#	149IP	150IP	151IP	152IP	159IP	153IP
CATEGORY	0	0 TO 1	1	1	1	1
PIN DIAMETER	5/8"	7/8"	7/8"	7/8"	7/8"	7/8"
USABLE LENGTH	ADJUSTABLE	1-3/4"	ADJUSTABLE	1-3/4"	ADJUSTABLE	2-1/4"
OVERALL LENGTH	3-7/8"	4-5/8"	5"	5-1/2"	6-1/4"	6-1/2"
THREAD DIA.	5/8" NF	5/8" NF	7/8" NF	7/8" NF	7/8" NF	7/8" NF
UNIT WEIGHT (LBS)	0.8	0.65	1.1	1.1	1.25	1.3
ORDER MULTIPLES	5	5	5	5	5	5

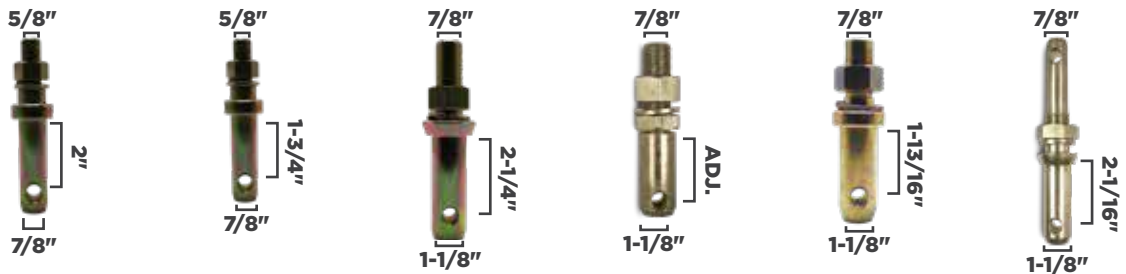

PART#	164IP*	163IP**	156IP	154IP	155IP	162IP
CATEGORY	1	1	1 TO 2	1 TO 2	1 TO 2	1 & 2
PIN DIAMETER	7/8"	7/8"	1-1/8"	1-1/8"	1-1/8"	1-1/8" & 7/8"
USABLE LENGTH	2"	1-3/4"	2-1/4"	ADJUSTABLE	1-13/16"	2-1/16" BOTH
OVERALL LENGTH	5"	4-1/2"	6-5/16"	5-1/4"	5-1/4"	8"
THREAD DIA.	5/8" NF	5/8" NF	7/8" NF	7/8" NF	7/8" NF	1" NF
UNIT WEIGHT (LBS)	0.85		1.7	1.35	1.45	2
ORDER MULTIPLES	5	5	5	5	5	5

*164IP REPLACES FORD 103283, MF662459M1, MF00955-7-7/8

**163IP REPLACES FORD 131010, 195425M1, D0955-4-1/2

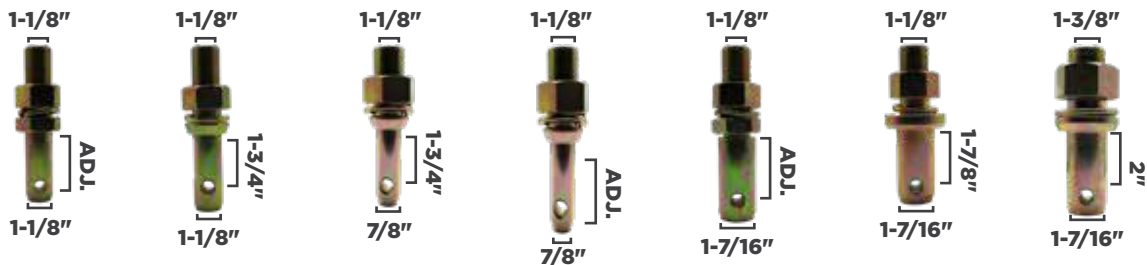

PART#	160IP	157IP	165IP	161IP	167IP	166IP	168IP
CATEGORY	2	2	2 TO 1	2 TO 1	2 TO 3	2 TO 3	3
PIN DIAMETER	1-1/8"	1-1/8"	7/8"	7/8"	1-7/16"	1-7/16"	1-7/16"
USABLE LENGTH	ADJUSTABLE	1-3/4"	1-3/4"	ADJUSTABLE	ADJUSTABLE	1-7/8"	2"
OVERALL LENGTH	6-1/8"	6-1/8"	5-3/4"	6-3/8"	6-1/2"	5-3/4"	5-7/8"
THREAD DIA.	1-1/8" NF	1-1/8" NF	1-1/8" NF	1-1/8" NF	1-1/8" NF	1-1/8" NF	1-3/8" NF
UNIT WEIGHT	2.2	2.15	1.8	1.8	2.8	2.8	3.5
ORDER MULTIPLES	5	5	5	5	5	5	5

*ITEMS ARE SOLD ONLY IN THE ORDER MULTIPLES LISTED

FORGED YELLOW ZINC DICHROMATE LIFT ARM PINS (SPECIALTY)



PART#	170IP	112P	113P	171IP	172IP
CATEGORY	1	1-2	1-2-1	2	2
TYPE	ROLL PIN	STEPPED PIN	STEPPED PIN	ROLL PIN	ROLL PIN
PIN DIAMETER	7/8"	7/8"-1-1/8"	7/8"-1-1/8"	1-1/8"	1-1/8"
USABLE LENGTH	4-1/2"	3"	2-7/8"	3-5/16"	4-3/4"
OVERALL LENGTH	6"	7-1/2"	8-3/8"	4-3/4"	6-1/2"
UNIT WEIGHT (LBS)		1.45	1.55	1.25	1.75
ORDER MULTIPLES	5	5	5	5	5



PART#	173IP	174IP	175IP	169IP	176IP	116P
CATEGORY	2	2	2	3	3	2 & 3
TYPE	ROLL PIN	ROLL PIN	ROLL PIN	HEAD	ROLL PIN	HEAD
PIN DIAMETER	1-1/8"	1-1/8"	1-1/8"	1-7/16"	1-7/16"	1-1/8" & 1-7/16"
USABLE LENGTH	5-3/8"	7-3/8"	9"	4-11/16"	6-1/4"	3-5/8" & 4-1/4"
OVERALL LENGTH	7"	9"	10-3/4"	6"	8-1/2"	9-1/4"
UNIT WEIGHT (LBS)	1.9	2.45	2.95	2.8	3.8	3.3
ORDER MULTIPLES	5	5	5	5	5	5

STABILIZER PINS



PART#	780P	781P	785P	787P	788P
PIN DIAMETER	7/8"	7/8"	7/8"	7/8"	7/8"
USABLE LENGTH	1/2"	3/8"	1-1/4"	1/2"	11/16"
OVERALL LENGTH	3-3/8"	2-5/8"	3-1/8"	2-5/8"	3-1/8"
THREAD DIA.	7/8" NF	5/8" NF	5/8" NF	5/8" NF	3/4" NF
UNIT WEIGHT (LBS)	0.8	0.4	0.4	0.4	0.55
ORDER MULTIPLES	5	5	5	5	5

*ITEMS ARE SOLD ONLY IN THE ORDER MULTIPLES LISTED
*ITEMS ARE SOLD ONLY IN THE ORDER MULTIPLES LISTED

FORGED YELLOW ZINC DICHROMATE TOP LINK PINS

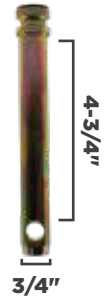
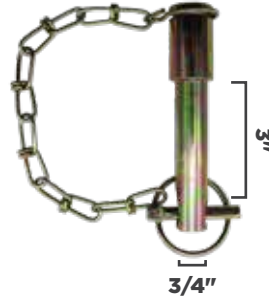
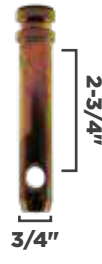
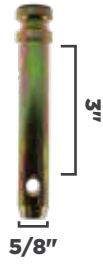

PART#	104P	105P	115P	107P	110P
CATEGORY	0	1	1	1	1
PIN DIAMETER	5/8"	3/4"	3/4"	3/4"	3/4"
USABLE LENGTH	3"	2-3/4"	3"	3-7/8"	4-3/4"
OVERALL LENGTH	4-7/16"	4-1/2"	5-1/4"	5-1/2"	6-3/8"
UNIT WEIGHT	0.35	0.55	0.9	0.65	0.75
ORDER MULTIPLES	5	5	5	5	5

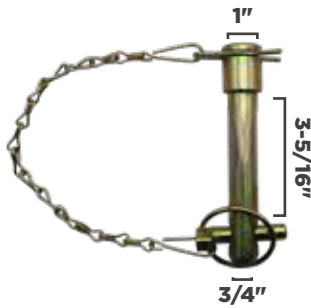

PART#	114P	111P	106P	103P
CATEGORY	1-2	1-2	2	2
PIN DIAMETER	3/4"-1"	3/4"-1"	1"	1"
USABLE LENGTH	3-5/16"	2-1/4"	3-9/16"	3"
OVERALL LENGTH	5-1/2"	6-3/4"	5-1/4"	4-3/4"
UNIT WEIGHT (LBS)	0.9	1.1	1.1	1.05
ORDER MULTIPLES	5	5	5	5

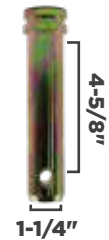
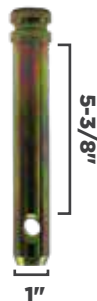
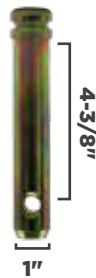

PART#	108P	117P	118P	109P
CATEGORY	2	2	2	3
PIN DIAMETER	1"	1"	1"	1-1/4"
USABLE LENGTH	4-3/8"	5-3/8"	4-1/4"	4-5/8"
OVERALL LENGTH	6"	7-1/16"	6-1/8"	6-1/2"
UNIT WEIGHT (LBS)	1.3	1.55	1.35	2.3
ORDER MULTIPLES	5	5	5	5

*ITEMS ARE SOLD ONLY IN THE ORDER MULTIPLES LISTED

FORGED ZINC PLATED TOP LINKS

CATEGORY 0



7-5/8"

CATEGORY 1



13-1/4"

CATEGORY 1

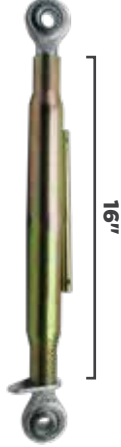

16"

CATEGORY 1



20"

CATEGORY 1



24"

CATEGORY 1 & 2

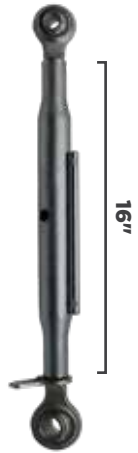

16"

PART#	204TL	205TL	206TL	207TL	212TL	208TL
CATEGORY	0	1	1	1	1	1 & 2
PIN HOLE SIZE	5/8"	3/4"	3/4"	3/4"	3/4"	3/4" & 1"
THREADS	3/4" NC	1-1/8" NC	1-1/8" NC	1-1/8" NC	1-1/8" NC	1-1/8" NC
BODY LENGTH	7-5/8"	13-1/4"	16"	20"	24"	16"
CLOSED LENGTH	11"	17"	21"	25"	29"	21"
OPEN LENGTH	16"	26"	31"	35"	39"	32"
UNIT WEIGHT (LBS)	2.5	7.4	7.6	9.1	8.9	9.1
ORDER MULTIPLES	1	1	1	1	1	1

CATEGORY 1 & 2

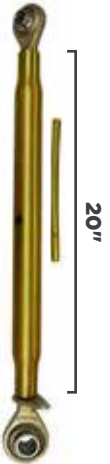

20"

CATEGORY 2



16"

CATEGORY 2

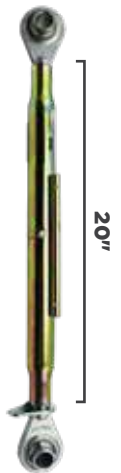

20"

CATEGORY 2



20"

CATEGORY 2

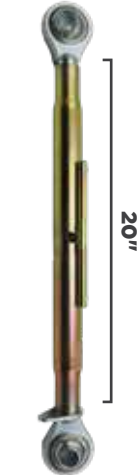

20"

CATEGORY 3

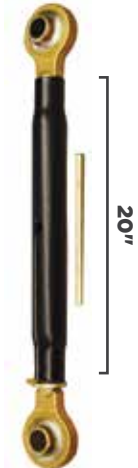

20"

PART#	213TL	209TL	210TL	209TLHD	210TLHD	250TLA
CATEGORY	1 & 2	2	2	2	2	3
PIN HOLE SIZE	3/4" & 1"	1"	1"	1"	1"	1-1/4"
THREADS	1-1/8" NC	1-1/8" NC	1-1/8" NC	1-1/4" NC	1-1/4" NC	1-3/8" NC
BODY LENGTH	20"	16"	20"	15-3/4"	20"	19-1/2"
CLOSED LENGTH	25"	21"	25"	20"	27"	25-1/2"
OPEN LENGTH	35"	31"	37"	30"	37"	37"
UNIT WEIGHT (LBS)	10.1	10	10	10.7	12.6	20
ORDER MULTIPLES	1	1	1	1	1	1

*ITEMS ARE SOLD ONLY IN THE ORDER MULTIPLES LISTED

HYDRAULIC TOP LINKS

CATEGORY 1 HYDRAULIC TOP LINK KIT WITH HYDRAULIC HOSES & Q/C COUPLERS
46.120.008

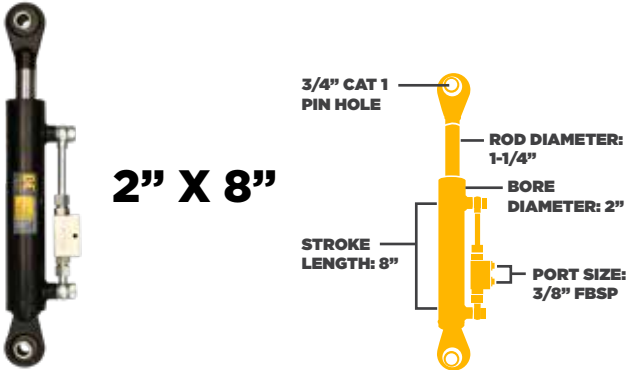

CATEGORY 2 HYDRAULIC TOP LINK KIT WITH HYDRAULIC HOSES & Q/C COUPLERS
46.220.008

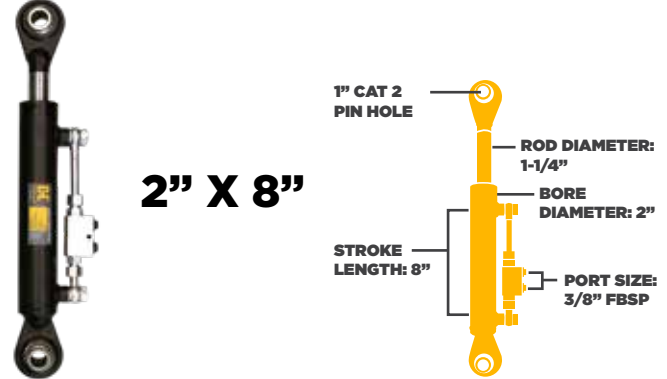

CATEGORY 2 HYDRAULIC TOP LINK KIT WITH HYDRAULIC HOSES & Q/C COUPLERS
46.225.010

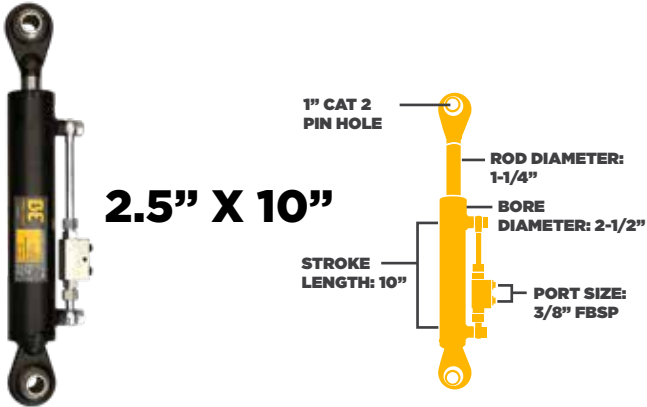

CATEGORY 2 HYDRAULIC TOP LINK KIT WITH HYDRAULIC HOSES & Q/C COUPLERS
46.230.008

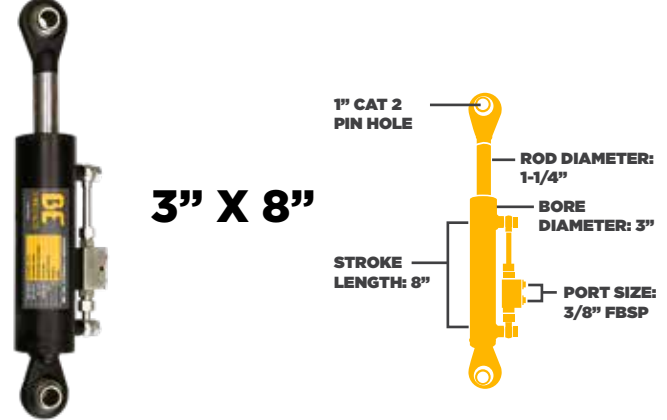

PART NUMBER	46.120.008	46.220.008	46.225.010	46.230.008
CATEGORY	1	2	2	2
COLLAPSED LENGTH	20"	20"	21.5"	22"
EXTENDED LENGTH	28"	28"	31.5"	30"
HOSE LENGTH	36"	36"	36"	36"
OPERATING PRESSURE	2,175 PSI	2,175 PSI	2,175 PSI	2,175 PSI
PUSH CAPACITY	6,490 LBS	6,490 LBS	10,300 LBS	14,600 LBS
PULL CAPACITY	3,830 LBS	3,830 LBS	7,640 LBS	10, 850 LBS



HYDRAULIC TOP LINK HOSE KIT WITH Q/C COUPLERS
46.000.038



- 36" hose length
- 1/2" NPT thread tractor end
- 3/8" BSP thread cylinder end
- 3/8" SAE 100 2RAT hose type

MAX PSI
4800



TOP LINK REDUCER BUSHINGS

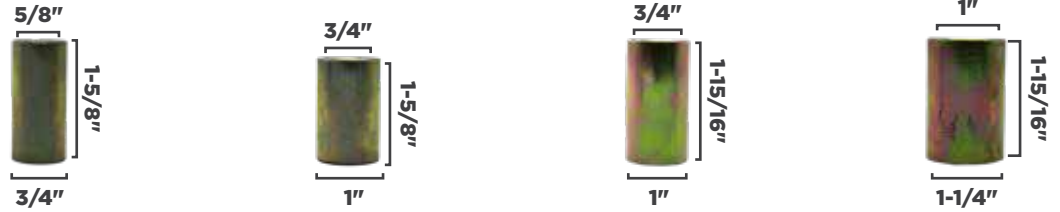

	PART #	PART #	PART #	PART #
BASE #	474RB	478SRB	478RB	480RB
RETAIL BAG OF 2	474RBB2		478RBB2	480RBB2
CATEGORY	1-0	2-1	2-1	3-2
OUTSIDE DIA.	3/4"	1"	1"	1-1/4"
INSIDE DIA.	5/8"	3/4"	3/4"	1"
LENGTH	1-5/8"	1-5/8"	1-15/16"	1-15/16"
UNIT WEIGHT (LBS)	0.05	0.15	0.2	0.2
ORDER MULTIPLES	5	5	5	5

LIFT ARM REDUCER BUSHINGS

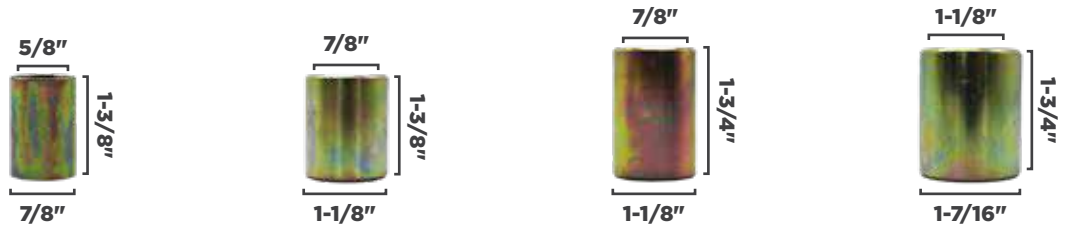

	PART #	PART #	PART #	PART #
BASE #	475RB	477SRB	477RB	479RB
RETAIL BAG OF 2	475RBB2		477RBB2	479RBB2
CATEGORY	1-0	2-1	2-1	3-2
OUTSIDE DIA.	7/8"	1-1/8"	1-1/8"	1-7/16"
INSIDE DIA.	5/8"	7/8"	7/8"	1-1/8"
LENGTH	1-3/8"	1-3/8"	1-3/4"	1-3/4"
UNIT WEIGHT (LBS)	0.1		0.2	
ORDER MULTIPLES	5	5	5	5

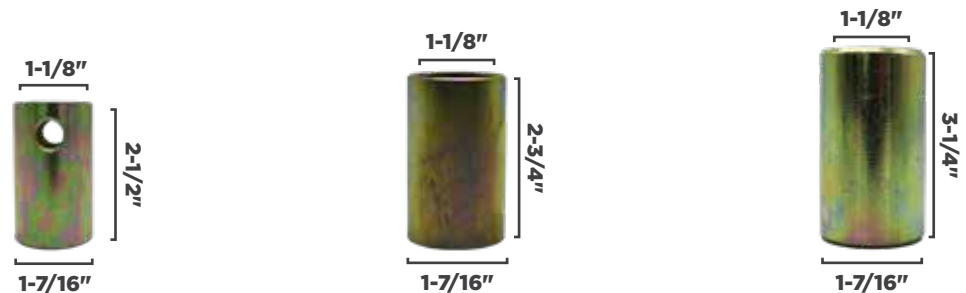

	PART #	PART #	PART #
BASE #	481RB	482RB	483RB
RETAIL BAG OF 2	481RBB2		
CATEGORY	3-2	3-2	3-2
OUTSIDE DIA.	1-7/16"	1-7/16"	1-7/16"
INSIDE DIA.	1-1/8"	1-1/8"	1-1/8"
LENGTH	2-1/2"	2-3/4"	3-1/4"
UNIT WEIGHT (LBS)		0.5	
ORDER MULTIPLES	5	5	5

*ITEMS ARE SOLD ONLY IN THE ORDER MULTIPLES LISTED

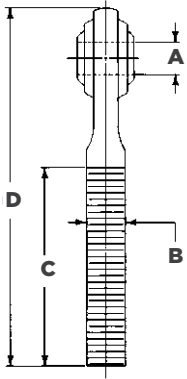

CATEGORY 1

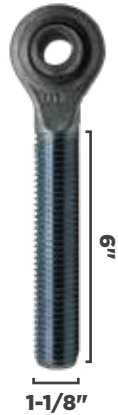

CATEGORY 1

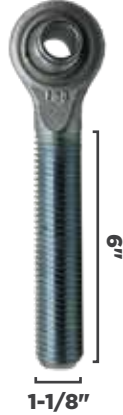

CATEGORY 2



CATEGORY 2



PART#	400BE	401BE	406BE	407BE
CATEGORY	1	1	2	2
TYPE	FORGED	FORGED	FORGED	FORGED
A	3/4"	3/4"	1"	1"
B	1-1/8" NC (LH)	1-1/8" NC (RH)	1-1/4" NC (LH)	1-1/4" NC (RH)
C	6"	6"	5-1/2"	5-1/2"
D	10"	10"	10"	10"
UNIT WEIGHT (LBS)	2.4	2.4	3	3
ORDER MULTIPLES	1	1	1	1

CATEGORY 2

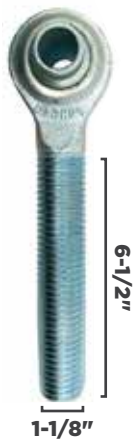

CATEGORY 2

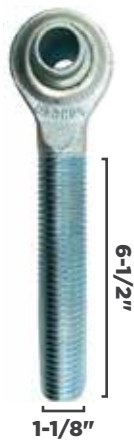

CATEGORY 3



CATEGORY 3



PART#	403BE	402BE	405BE	404BE
CATEGORY	2	2	3	3
TYPE	FORGED	FORGED	FORGED	FORGED
A	1"	1"	1-1/4"	1-1/4"
B	1-1/8" NC (RH)	1-1/8" NC (LH)	1-3/8" NC (RH)	1-3/8" NC (LH)
C	6-1/2"	6-1/2"	7-1/4"	7-1/4"
D	11"	11"	12-1/8"	12-1/8"
UNIT WEIGHT (LBS)	3	8	8	8
ORDER MULTIPLES	1	1	1	1

*ITEMS ARE SOLD ONLY IN THE ORDER MULTIPLES LISTED

TOP LINK & LIFT ARM WELD-ON REPAIR ENDS

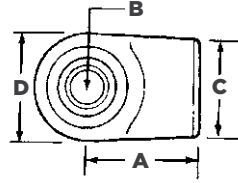
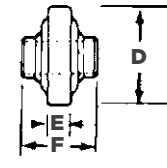
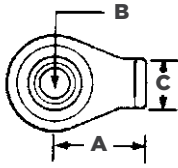

- High-quality, weld-on top link and lift arm ball sockets in Category 1, 2, & 3 sizes
- Lift arm ends are available in straight and bent styles

**TOP LINK END
CATEGORY 1**

**TOP LINK END
CATEGORY 2**

**LIFT ARM END
CATEGORY 1**

**LIFT ARM END
CATEGORY 1**



1-1/8"



1-1/8"



2-3/8"



1-7/8"

PART #	480E	481E	482E	485E
CATEGORY	1	2	1	1
DESCRIPTION	STRAIGHT	STRAIGHT	STRAIGHT	BENT
A	2"	2-3/8"	2-3/4"	4"
B	3/4"	1"	7/8"	7/8"
C	1-1/8"	1-1/8"	2-3/8"	1-7/8"
D	2-1/4"	2-5/8"	2-5/8"	2-5/8"
E	1/2"	1/2"	5/8"	5/8"
F	1-3/4"	2"	1-3/8"	1-3/8"
ORDER MULTIPLES	1	1	1	1

**LIFT ARM END
CATEGORY 2**



2-3/4"

**LIFT ARM END
CATEGORY 2**



1-7/8"

**LIFT ARM END
CATEGORY 3**



3"

PART #	483E	484E	487E
CATEGORY	2	2	3
DESCRIPTION	STRAIGHT	BENT	STRAIGHT
A	3-1/8"	4"	3-3/8"
B	1-1/8"	1-1/8"	1-7/16"
C	2-3/4"	1-7/8"	3"
D	3-1/8"	3-1/8"	3-1/2"
E	3/4"	5/8"	3/4"
F	1-3/4"	1-3/4"	1-3/4"
ORDER MULTIPLES	1	1	1

*ITEMS ARE SOLD ONLY IN THE ORDER MULTIPLES LISTED

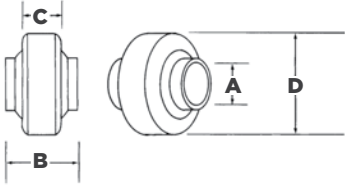

PART#	B-213B	B-213	B-212	B-235	B-228
CATEGORY	1	1	1	1 & 2	2
DESCRIPTION	BLACK OXIDE	PLATED	HD PLATED	BLACK OXIDE	PLATED
A	3/4"	3/4"	3/4"	3/4" & 1"	1"
B	1-5/8"	1-5/8"	1-5/8"	1-1/2" & 1-1/4"	1-1/4"
C	3/4"	3/4"	7/8"	7/8"	7/8"
D	2"	2"	2-1/8"	2-3/8"	2-3/8"
UNIT WEIGHT (LBS)	0.6	0.6	0.7	0.6	0.8
ORDER MULTIPLES	2	2	2	2	2



PART#	B-214B	B-214	B-2219	B-2229
CATEGORY	2	2	2	3
DESCRIPTION	BLACK OXIDE	PLATED	HD BLACK OXIDE	BLACK OXIDE
A	1"	1"	1"	1-1/4"
B	1-3/4"	1-3/4"	1-3/4"	1-3/4"
C	7/8"	7/8"	1-3/16"	1-9/32"
D	2-3/8"	2-3/8"	2-3/4"	3-1/8"
UNIT WEIGHT (LBS)	0.8	0.8	1.8	1.8
ORDER MULTIPLES	2	2	2	2

*ITEMS ARE SOLD ONLY IN THE ORDER MULTIPLES LISTED

LIFT ARM BALL SOCKETS

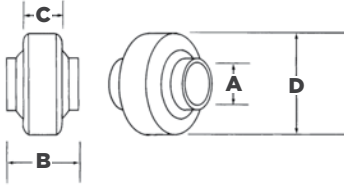

CATEGORY 1



2-3/8"

CATEGORY 1



2-3/8"

CATEGORY 2



2-3/8"

PART#	B-221B	B-221	B-222
CATEGORY	1	1	2
DESCRIPTION	BLACK OXIDE	PLATED	PLATED
A	7/8"	7/8"	1-1/8"
B	1-3/8"	1-3/8"	1-5/16"
C	7/8"	7/8"	15/16"
D	2-3/8"	2-3/8"	2-3/8"
UNIT WEIGHT (LBS)	0.90	0.90	0.85
ORDER MULTIPLES	2	2	2

CATEGORY 2



3-1/8"

CATEGORY 2



3-1/8"

CATEGORY 3



3-1/2"

PART#	B-2215	B-2216	B-2231
CATEGORY	2	2	3
DESCRIPTION	EXTRA HD, BLACK OXIDE	EXTRA HD, PLATED	BLACK OXIDE
A	1-1/8"	1-1/8"	1-7/16"
B	1-3/4"	1-3/4"	1-3/4"
C	1-3/8"	1-3/8"	1-11/32"
D	3-1/8"	3-1/8"	3-1/2"
UNIT WEIGHT (LBS)	2.20	1.90	2.60
ORDER MULTIPLES	2	2	2

*ITEMS ARE SOLD ONLY IN THE ORDER MULTIPLES LISTED

TOP LINK BALLS

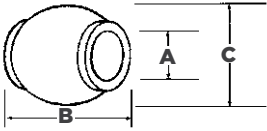

CATEGORY 1



1-3/4"

CATEGORY 2



1-3/4"

PART#	B-241	B-242
CATEGORY	1	2
DESCRIPTION	JOHN DEERE & OLIVER	JOHN DEERE & OLIVER
A	3/4"	1"
B	1-3/4"	1-3/4"
C	2"	2"
UNIT WEIGHT (LBS)	0.95	0.80
ORDER MULTIPLES	1	1

LIFT ARM BALL SOCKETS

CATEGORY 1



1-3/8"

CATEGORY 1



1-3/8"

CATEGORY 2



1-3/4"

PART#	454B	450B	453B
CATEGORY	1	1	2
DESCRIPTION	OLIVER	FORD	OLIVER
A	7/8"	7/8"	1-1/8"
B	1-3/8"	1-3/8"	1-3/4"
C	2"	2-1/4"	2"
UNIT WEIGHT (LBS)			
ORDER MULTIPLES	1	1	1

CATEGORY 2



1-3/8"

CATEGORY 2



1-3/8"

CATEGORY 2



1-3/4"

PART#	451B	451BH	452B
CATEGORY	2	2	2
DESCRIPTION	FORD	FORD	FORD
A	1-1/8"	1-1/8"	1-1/8"
B	1-3/8"	1-3/8"	1-3/4"
C	2-1/4"	2-1/4"	2-1/4"
UNIT WEIGHT (LBS)			
ORDER MULTIPLES	1	1	1

*ITEMS ARE SOLD ONLY IN THE ORDER MULTIPLES LISTED

CATEGORY 0 CATEGORY 0/1 CATEGORY 1 CATEGORY 1 CATEGORY 2 CATEGORY 2 CATEGORY 3

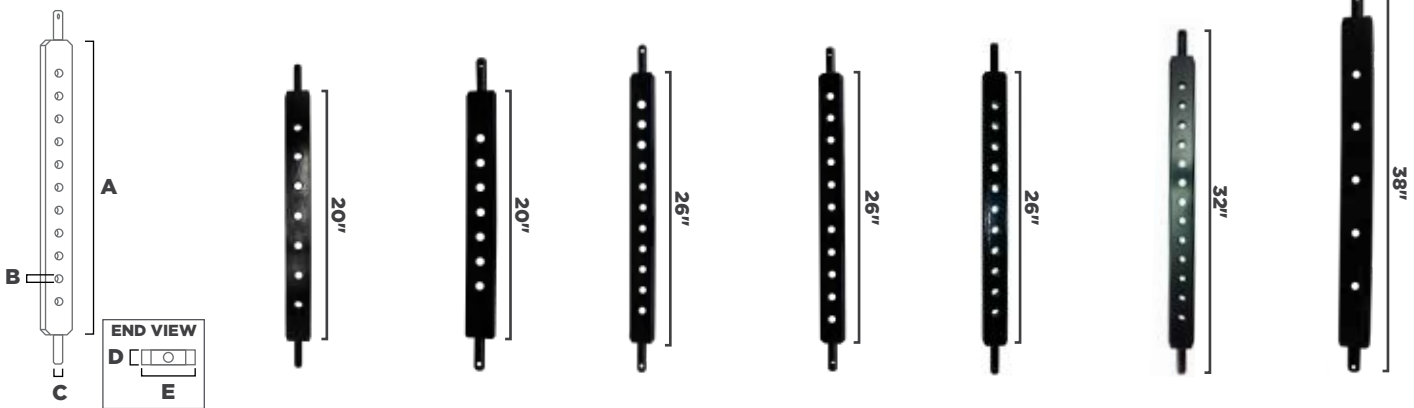

PART#	1005DB	1000DB	1002DB	1004DB	1003DB	1001DB	1008DB
CATEGORY	0	0/1	1	1	2	2	3
NO. OF HOLES	7	7	11	11	11	13	5
LIFT ARM SPACING	20"	20"	26"	26"	26"	32"	38"
HOLE DIA.	5/8"	3/4"	3/4"	3/4"	3/4"	3/4"	1-1/4"
PIN DIA.	5/8"	7/8"	7/8"	7/8"	1-1/8"	1-1/8"	1-7/16"
THICKNESS	5/8"	1"	1"	1-1/8"	1-1/4"	1-1/4"	1-3/4"
WIDTH	2"	2-1/2"	2-1/2"	2-1/2"	3"	3"	3-1/2"
COLOR	BLACK	BLACK	BLACK	BLACK	BLACK	BLACK	BLACK
UNIT WEIGHT (LBS)	13.5	13.5	16.4	18.25	27	33	65
ORDER MULTIPLES	1	1	1	1	1	1	1

DRAWBAR HOOK
64.038.002



- For all tractor drawbars up to 1-5/8" thick
- For use with 5/16" to 1/2" chain

UNIVERSAL STABILIZER BRACKET
SB-631



- LH & RH 5/8" x 1" slotted hole
- 4-5/8" mounting holes

DRAWBAR LOCK
BEDBL2



SWINGING DRAWBAR
FITS ALL TRACTOR MODELS
SD-921



*ITEMS ARE SOLD ONLY IN THE ORDER MULTIPLES LISTED

UPPER STAY STRAP FOR CAT 1

304S



- Fits: all Ferguson models, Ford 2N, 8N, 9N, NAA, 600, 700, 800, 900, Oliver 550 & all Oliver 3 point
- Conversions: Massey-Ferguson 35 & 50
- Weight: 2.8 lbs

LOWER STAY STRAP FOR CAT 1

303S



- Fits: all Ferguson models. Ford 2N, 8N, 9N, NAA, 600, 700, 800, 900, Oliver 550 & all Oliver 3 point
- Conversion: Massey-Ferguson 35 & 50
- Weight: 2.4 lbs

RIGHT OR LEFT UNIVERSAL STABILIZER ARM

301S



- 7/8" pin holes on 31-9/16" centers
- Weight: 6 lbs

RIGHT OR LEFT UNIVERSAL STABILIZER ARM

302S



- Replaces Massey-Ferguson ST96362358; 7/8" pin holes on 33-1/8" centers
- Weight: 6.4 lbs

HEAVY-DUTY ADJUSTABLE FORGED STABILIZER ARM

300S



- Fits: all Ferguson models, Ford 2N, 8N, 9N, NAA, 600, Massey-Ferguson 35, 50, 175, 65, 135, 150, 165, 180;
- Adjustable from 28-1/2" to 36" ; 7/8" pin holes; 7/8" NF threads
- Weight: 6 lbs

UNIVERSAL STABILIZER ARM

309S



- 7/8" pin holes on 31-9/16" and 33-1/8" centers; 3 hole
- Weight: 6.1 lbs

PAIR OF UNIVERSAL STABILIZER CHAINS

310S



- For most Category 1 applications
- Yellow zinc plated
- Weight: 14 lbs

CATEGORY 1 RIGHT- OR LEFT-HAND FORGED LIFT ARM

486E



- Fits: all Ferguson models, Ford 2N, 8N, 9N, NAA, Massey-Ferguson 35, 50, Oliver 550 and Oliver 3-point conversion, John Deere 1010; 7/8" pin holes; 31-3/4" ball centers; 34-1/2" overall length
- Weight: 11.7 lbs

CATEGORY 1 LIFT ARM LEVELING ASSEMBLY

351JA



- 18-1/2" closed; 25" open length
- 7/8" NF thread diameter; replaces Ford NCA577A
- Weight: 6 lbs

COMPLETE CATEGORY 1 3 POINT HITCH ASSEMBLY

10003PT



CHECK-CHAIN CLEVIS EYE BOLT

1641K



- Used to fasten check-chain to lift arms; replaces Ford NCB660A
- Fits Ferguson 20 & 30; assembled with 9/16" NF hex nut
- Weight: 0.4 lbs

CHECK-CHAIN CLEVIS

1642K



- Used to fasten check-chain to tractor;
- Replaces: Ford 9N582
- Fits: MF 20, 30, 35, 40 and 50
- Weight: 0.1 lbs

QUICK HITCH PARTS & ACCESSORIES

QUICK HITCH ADAPTER BUSHING KIT CATEGORY 3-1

QK1-B



QUICK HITCH ADAPTER BUSHING KIT CATEGORY 3-2

QK2-B



QUICK HITCH ADAPTER BUSHING CATEGORY 2

473RB



QUICK HITCH ADAPTER BUSHING CATEGORY 1

472RB



ROLL PINS

QK-RP

- For quick hitch adapter bushings
- 2 Pieces
- 12 mm x 35 mm



QUICK HITCH TOP LINK ADAPTER BRACKET

CATEGORY 1

QK1-A



QUICK HITCH MOUNT PIN CATEGORY 1

QK1-C



QUICK HITCH MOUNT PIN CATEGORY 2

QK2-C



QUICK HITCH MOUNT PIN CATEGORY 2, 3

QK2-3-C



QUICK HITCH MOUNT PIN CATEGORY 3

QK3-C



ZINC PLATED HAIR PINS



	PART #		PART #		PART #		PART #		PART #	
BASE #	P-7922		P-7923		P-7924		P-7925		P-7926	
RETAIL BAG			P-7923B12	12PC	P-7924B8	8PC	P-7925B7	7PC		
RETAIL CLAMSHELL	P-7922BP20	20PC	P-7930	22PC	P-7933	8PC	P-7932	7PC		
SIZE	1/16" X 1-9/16"		3/32" X 1-5/8"		1/8" X 1-15/16"		5/32" X 2-15/16"		3/16" X 3-7/32"	
FITS PIN DIA	3/8" - 1/2"		1/4" - 1/2"		1/2" - 3/4"		5/8" - 1"		7/8" - 1"	

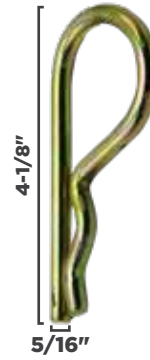
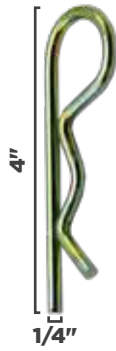

	PART #		PART #		PART #		PART #		PART #	
BASE #	P-7927		P-7928		P-7940		P-7929S		P-7929	
RETAIL BAG	P-7927B3	3PC	P-7928B2	2PC			P-7929SB2	2PC	P-7929B2	2PC
RETAIL CLAMSHELL	P-7931	4PC	P-7928BP2	2PC					P-7935	1PC
SIZE	3/16" X 3-3/4"		1/4" X 4"		5/16" X 3-1/2"		5/16" X 4-1/8"		5/16" X 5-15/16"	
FITS PIN DIA	7/8" - 1-1/4"		3/4" - 1"		1" - 1-7/16"		1" - 1-7/16"		1" - 1-7/16"	



CONTAINS:
P-7923, P-7924,
P-7925, P-7927

AVAILABLE IN THE MOST POPULAR SIZES FOR FARM AND OTHER APPLICATIONS.

YELLOW ZINC DICHROMATE PLATED SPRING WIRE.



P-7925B7



P-7932

	PART #	PART #	PART #
BASE #	P-7995	P-7997	
RETAIL BAG			
RETAIL CLAMSHELL			P-7936
SIZE	1/8" X 2-1/2"		3/16" X 4-3/32"
FITS PIN DIA	1/2" - 3/4"		7/8" - 1-1/4"

*BASE # ARE SOLD IN MULTIPLES OF 100 ONLY

ZINC PLATED OR BLACK POWDER COATED LYNCH PINS

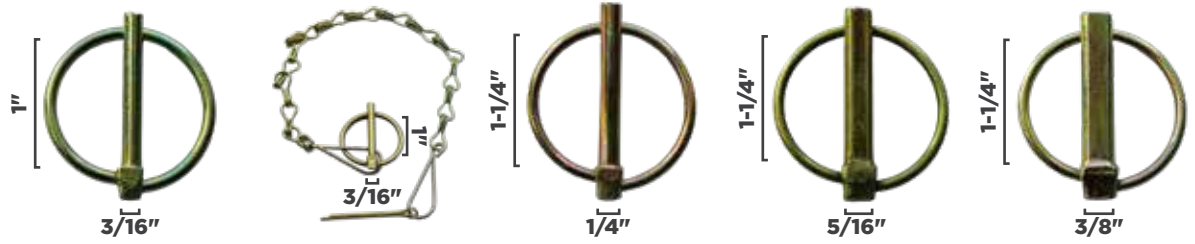

	PART #	PART #	PART #	PART #	PART #
* BASE #	804LP	804LPC	800LP	802LP	805LP
RETAIL BAG OF 2	804LPB2		800LPB2	802LPB2	
CLAMSHELL OF 4	804LPBP4		800LPBP4	802LPBP4	
RETAIL BAG OF 10			800LPB10		
STAINLESS STEEL			800LPSS		
SIZE	3/16" X 1"	3/16" X 1"	1/4" X 1-1/4"	5/16" X 1-1/4"	3/8" X 1-1/4"
UNIT WEIGHT (LBS)	0.05	0.05	0.10	0.05	0.10



	PART #	PART #	PART #	PART #	PART #
* BASE #	801LP	806LP	810LP	809LP	803LP
RETAIL BAG OF 2	801LPB2				803LPB2
CLAMSHELL OF 4	801LPBP4				
RETAIL BAG OF 10	801LPB10				
SIZE	7/16" X 1-1/4"	7/16" X 1-1/4"	7/16" X 1-1/4"	7/16" X 1-1/2"	7/16" X 1-1/2"
UNIT WEIGHT (LBS)	0.10	0.15	0.10	0.10	0.15

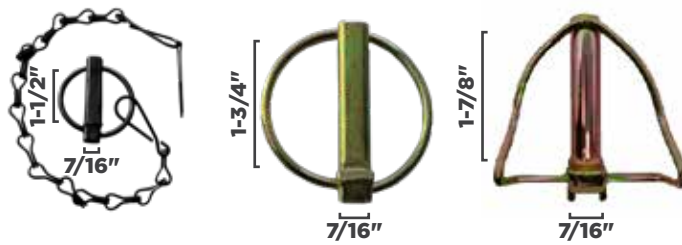

	PART #	PART #	PART #
* BASE #	803LPC	811LP	808LP
RETAIL BAG OF 2			
CLAMSHELL OF 4			
RETAIL BAG OF 10			
SIZE	7/16" X 1-1/2"	7/16" X 1-3/4"	7/16" X 1-7/8"
UNIT WEIGHT (LBS)	0.15	0.10	0.10

***BASE # ARE SOLD IN MULTIPLES OF 100 ONLY**

*BASE # ARE SOLD IN MULTIPLES OF 100 ONLY

PTO LOCK PINS

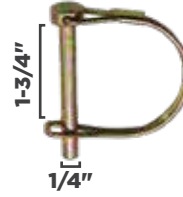

	PART #	PART #	PART #	PART #	PART #
**BASE #	907PA	916PA	922PA	914PA	920PA
RETAIL BAG OF 2					
SIZE	3/8" X 2-1/2"	3/8" X 3"	5/16" X 3-1/2"	3/8" X 3-7/8"	5/16" X 3-15/16"
UNIT WEIGHT (LBS)	0.15	0.20	0.15	0.20	0.15

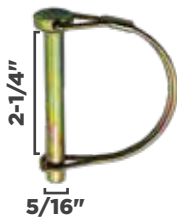

	PART #	PART #	PART #	PART #	PART #
**BASE #	900PA	906PA	903PA	918PA	911PA
RETAIL BAG OF 2	900PAB2	906PAB2	903PAB2		
SIZE	5/16" X 2-1/4"	3/8" X 2-1/4"	1/4" X 2-1/2"	5/16" X 2-1/2"	3/8" X 2-1/2"
UNIT WEIGHT (LBS)	0.10	0.15	0.10	0.10	0.15

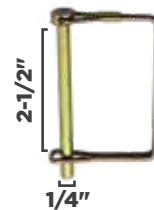
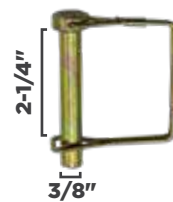
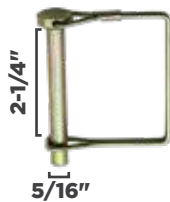
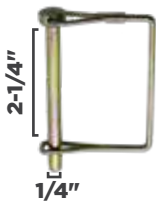

	PART #	PART #	PART #	PART #	PART #
**BASE #	910PA	904PA	905PA	909PA	915PA
RETAIL BAG OF 2		904PAB2	905PAB2		
SIZE	1/4" X 2-1/4"	5/16" X 2-1/4"	3/8" X 2-1/4"	1/4" X 2-1/2"	5/16" X 2-1/2"
UNIT WEIGHT (LBS)	0.10	0.10	0.10	0.10	0.10

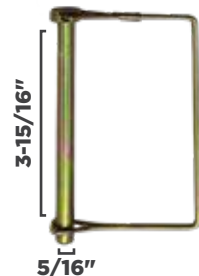
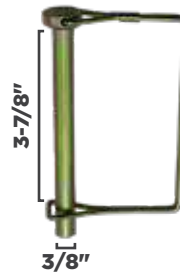
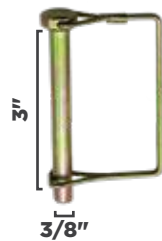
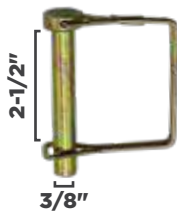

	PART #	PART #	PART #	PART #	PART #
**BASE #	907PA	916PA	922PA	914PA	920PA
RETAIL BAG OF 2					
SIZE	3/8" X 2-1/2"	3/8" X 3"	5/16" X 3-1/2"	3/8" X 3-7/16"	5/16" X 3-15/16"
UNIT WEIGHT (LBS)	0.15	0.20	0.15	0.20	0.15

**BASE # ARE SOLD IN MULTIPLES OF 10 ONLY

SAFETY PINS



PART#	68.100.001	68.100.002	68.100.003
PIN DIAMETER	1/8"	3/16"	1/4"
USABLE LENGTH	3-1/8"	3-3/8"	5-1/4"
ORDER MULTIPLES	10	10	10

COTTER PIN PACKS



PART#	67.700.381	67.700.382	67.700.383	67.700.384	67.700.387	67.700.388
PIN DIAMETER	3/32"	1/8"	1/8"	5/32"	3/16"	3/16"
USABLE LENGTH	1"	1"	1-1/2"	1"	1-1/2"	2"
PACK QTY	100	100	75	75	35	30



PART#	67.700.389	67.700.390	67.700.391
PIN DIAMETER	1/4"	1/4"	5/16"
USABLE LENGTH	1-1/2"	2"	2"
PACK QTY	20	17	10

*ITEMS ARE SOLD ONLY IN THE ORDER MULTIPLES LISTED

DETENT PINS

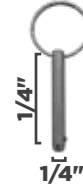

PART#	65.500.000	65.500.001	65.500.002	65.500.003
PIN DIAMETER	3/16"	1/4"	1/4"	1/4"
USABLE LENGTH	1"	1"	1-1/2"	2"
OVERALL LENGTH	1-3/8"	1-1/2"	2"	2-1/2"
ORDER MULTIPLES	5	5	5	5



PART#	65.500.004	65.500.005	65.500.006	65.500.007
PIN DIAMETER	1/4"	1/4"	5/16"	5/16"
USABLE LENGTH	2-1/2"	3"	1"	1-1/2"
OVERALL LENGTH	3"	3-1/2"	1-1/2"	2"
ORDER MULTIPLES	5	5	5	5

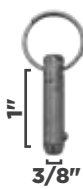
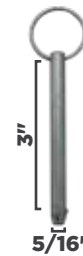
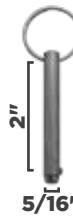

PART#	65.500.008	65.500.009	65.500.010	65.500.011
PIN DIAMETER	5/16"	5/16"	5/16"	3/8"
USABLE LENGTH	2"	2-1/2"	3"	1"
OVERALL LENGTH	2-1/2"	3"	3-1/2"	1-3/4"
ORDER MULTIPLES	5	5	5	5

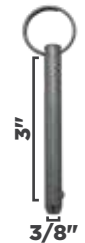
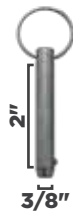

PART#	65.500.013	65.500.015	65.500.016	65.500.024
PIN DIAMETER	3/8"	3/8"	3/8"	1/2"
USABLE LENGTH	2"	3"	4"	2-1/2"
OVERALL LENGTH	2-3/4"	3-3/4"	4-5/8"	3-9/32"
ORDER MULTIPLES	5	5	5	5

*ITEMS ARE SOLD ONLY IN THE ORDER MULTIPLES LISTED

CLEVISES - STRAIGHT & TWISTED

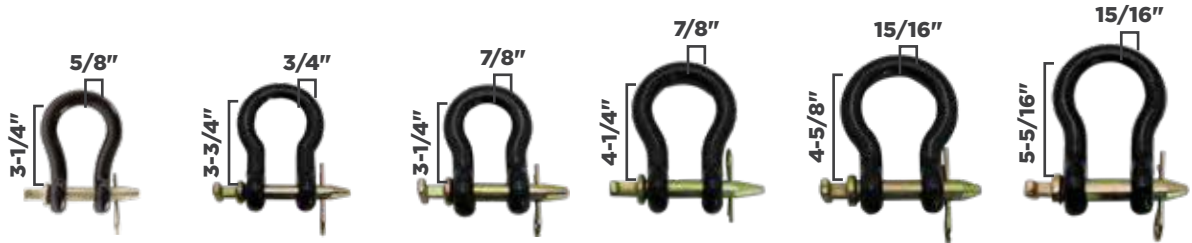

BULK PART#	64.300.058	64.300.075	64.300.078	64.301.078	64.301.516	64.300.001
BODY DIAMETER	5/8"	3/4"	7/8"	7/8"	15/16"	1"
CLEVIS OPENING	7/8"	1-5/16"	1-5/16"	1-5/16"	1-7/16"	2-1/8"
USABLE LENGTH	3-1/4"	3-3/4"	3-1/4"	4-1/4"	4-5/8"	5-5/16"
PIN DIAMETER	1/2"	5/8"	3/4"	3/4"	7/8"	1"
WORKING LOAD LIMIT (LBS)	6,000	12,000	16,000	16,000	20,000	25,000
UNIT WEIGHT (LBS)	1.25	2.35	3.05	3.45	4.50	6.25
ORDER MULTIPLES	1	1	1	1	1	1

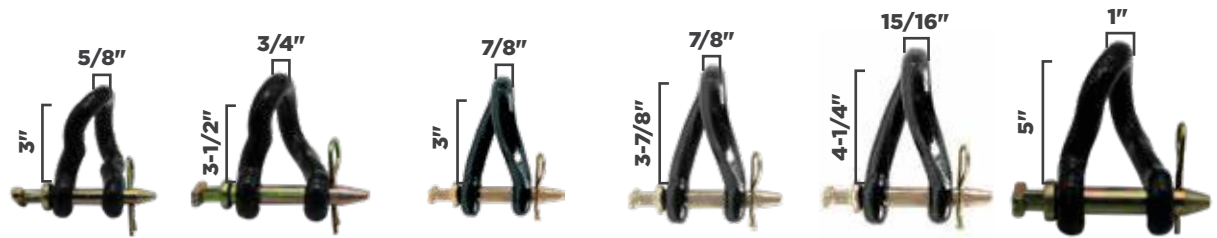

BULK PART#	64.200.058	64.200.075	64.201.078	64.200.078	64.201.516	64.200.001
BODY DIAMETER	5/8"	3/4"	7/8"	7/8"	15/16"	1"
CLEVIS OPENING	7/8"	1-5/16"	1-5/16"	1-5/16"	1-7/16"	2-1/8"
USABLE LENGTH	3"	3-1/2"	3"	3-7/8"	4-1/4"	5"
PIN DIAMETER	1/2"	5/8"	3/4"	3/4"	7/8"	1"
WORKING LOAD LIMIT (LBS)	6,000	12,000	16,000	16,000	20,000	25,000
UNIT WEIGHT (LBS)	1.30	2.30	3.00	3.50	4.20	6.30
ORDER MULTIPLES	1	1	1	1	1	1

REPLACEMENT PINS

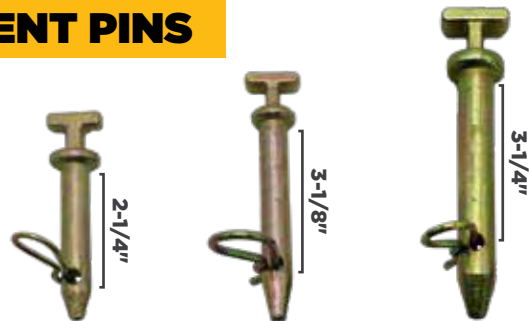

PART#	6070	6071	6072
DIAMETER	1/2"	5/8"	3/4"
USABLE LENGTH	2-1/4"	3-1/8"	3-1/4"
UNIT WEIGHT (LBS)	0.25	0.55	0.80
ORDER MULTIPLES	1	1	1



DO NOT EXCEED WORKING LOAD LIMIT. FARM HARDWARE IS NOT FOR LIFTING.

*ITEMS ARE SOLD ONLY IN THE ORDER MULTIPLES LISTED

UTILITY AND GENERAL PURPOSE CLEVISES

⚠ DO NOT EXCEED WORKING LOAD LIMIT. FARM HARDWARE IS NOT FOR LIFTING.

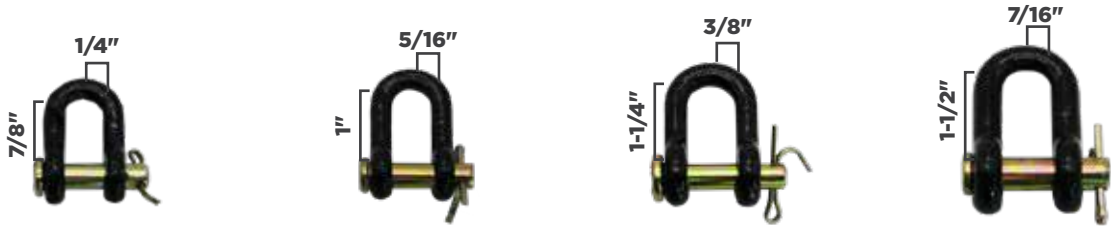

PART#	64.401.025	64.400.516	64.400.038	64.400.716
BODY DIAMETER	1/4"	5/16"	3/8"	7/16"
CLEVIS OPENING	15/32"	17/32"	21/32"	23/32"
USABLE LENGTH	7/8"	1"	1-1/4"	1-1/2"
PIN DIAMETER	5/16"	3/8"	7/16"	1/2"
WORKING LOAD LIMIT (LBS)	1,000	1,500	2,000	3,000
UNIT WEIGHT (LBS)	0.10	0.15	0.25	0.45
ORDER MULTIPLES	1	1	1	1

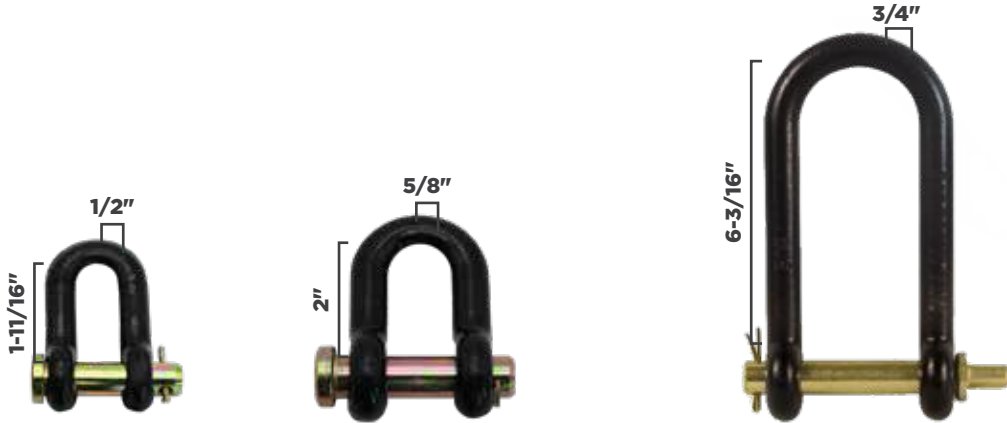

PART#	64.401.050	64.400.058	64.405.075
BODY DIAMETER	1/2"	5/8"	3/4"
CLEVIS OPENING	13/16"	1-1/16"	2-1/2"
USABLE LENGTH	1-11/16"	2"	6-3/16"
PIN DIAMETER	5/8"	3/4"	3/4"
WORKING LOAD LIMIT (LBS)	6,000	9,000	10,000
UNIT WEIGHT (LBS)	0.80	1.35	3.25
ORDER MULTIPLES	1	1	1

MID-LINKS



PART#	64.000.004	64.000.003	64.000.005
CHAIN SIZE	1/4" OR 5/16"	3/8"	7/16" OR 1/2"
WORKING LOAD LIMIT (LBS)	4700	6,600	11,300
UNIT WEIGHT (LBS)	0.35	0.45	1.05
ORDER MULTIPLES	1	1	1

*ITEMS ARE SOLD ONLY IN THE ORDER MULTIPLES LISTED

FARM CLEVISES

DO NOT EXCEED WORKING LOAD LIMIT. FARM HARDWARE IS NOT FOR LIFTING.

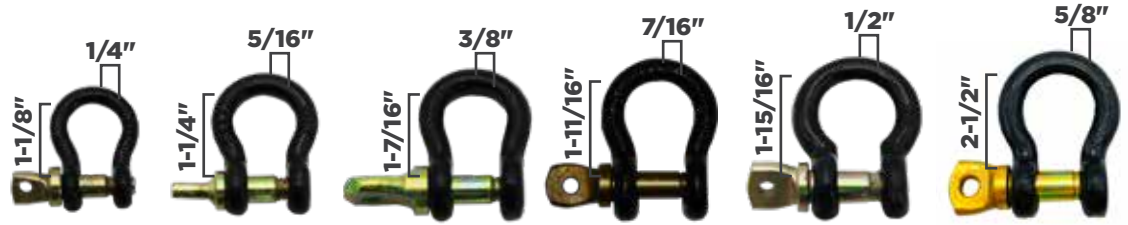

BULK PART#	64.350.025	64.350.516	64.350.038	64.350.716	64.350.050	64.350.058
BODY DIAMETER	1/4"	5/16"	3/8"	7/16"	1/2"	5/8"
CLEVIS OPENING	15/32"	17/32"	23/32"	3/4"	13/16"	1-1/16"
USABLE LENGTH	1-1/8"	1-1/4"	1-7/16"	1-11/16"	1-15/16"	2-1/2"
PIN DIAMETER	5/16"	3/8"	7/16"	1/2"	5/8"	3/4"
WORKING LOAD LIMIT (LBS)	1,000	2,000	3,000	4,000	6,500	9,000
UNIT WEIGHT (LBS)	0.10	0.20	0.25	0.40	0.80	0.60
ORDER MULTIPLES	1	1	1	1	1	1

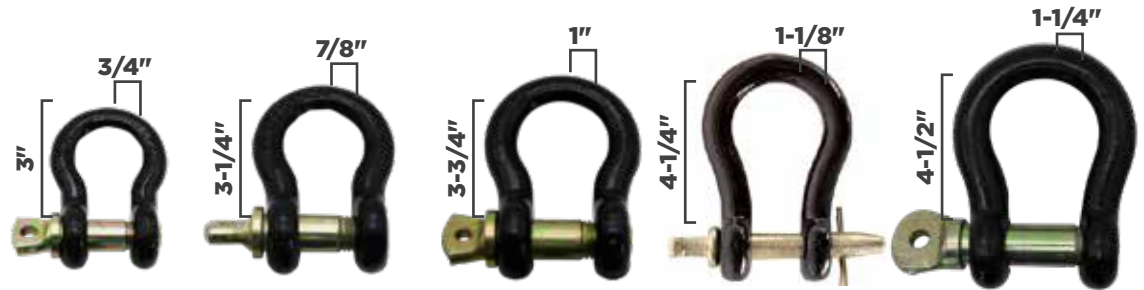

BULK PART#	64.350.075	64.350.078	64.350.001	64.350.118	64.300.114
BODY DIAMETER	3/4"	7/8"	1"	1-1/8"	1-1/4"
CLEVIS OPENING	1-1/4"	1-7/16"	1-11/16"	1-13/16"	2"
USABLE LENGTH	3"	3-1/4"	3-3/4"	4-1/4"	4-1/2"
PIN DIAMETER	7/8"	1"	1-1/8"	1-1/4"	1-3/8"
WORKING LOAD LIMIT (LBS)	13,000	15,000	17,000	24,000	28,000
UNIT WEIGHT (LBS)	2.25	3.50	4.95	6.80	10.80
ORDER MULTIPLES	1	1	1	1	1

MISCELLANEOUS FARM ACCESSORIES

CHECK-CHAIN CLEVIS EYE BOLT

1641K



- Used to fasten check-chain to lift arms
- Replaces: Ford NCB660A
- Fits: Ferguson 20 & 30
- Assembled with 9/16" NF hex nut
- Weight: 0.4 lbs

MUFFLER CLAMP ASSEMBLY

100901MC



- Replaces: Ford 9N5251
- Fits: Ford 2N, 8N, 9N, MF 20, 30, 40 and 50
- Weight: 0.6 lbs

DRILL DRAG CHAIN

2582AD



- Ring diameter: 3-1/2"
- Ring thickness: 1/2"
- Fits most standard seed drills
- Weight: 2.1 lbs

CHECK-CHAIN CLEVIS

1642K



- Used to fasten check-chain to tractors
- Replaces: Ford 9N582
- Fits: MF 20, 30, 35, 40 and 50
- Weight: 0.1 lbs

HEAVY-DUTY RATCHET JACK

350JA



- Clip pins & handle included
- Black powder-coat finish
- With 1-1/4" ACME threads & grease zerks
- Adjustable from 20" closed to 28" open 1" clevis pins
- Weight: 15 lbs



POWER TRANSMISSION PLAN-O-GRAM

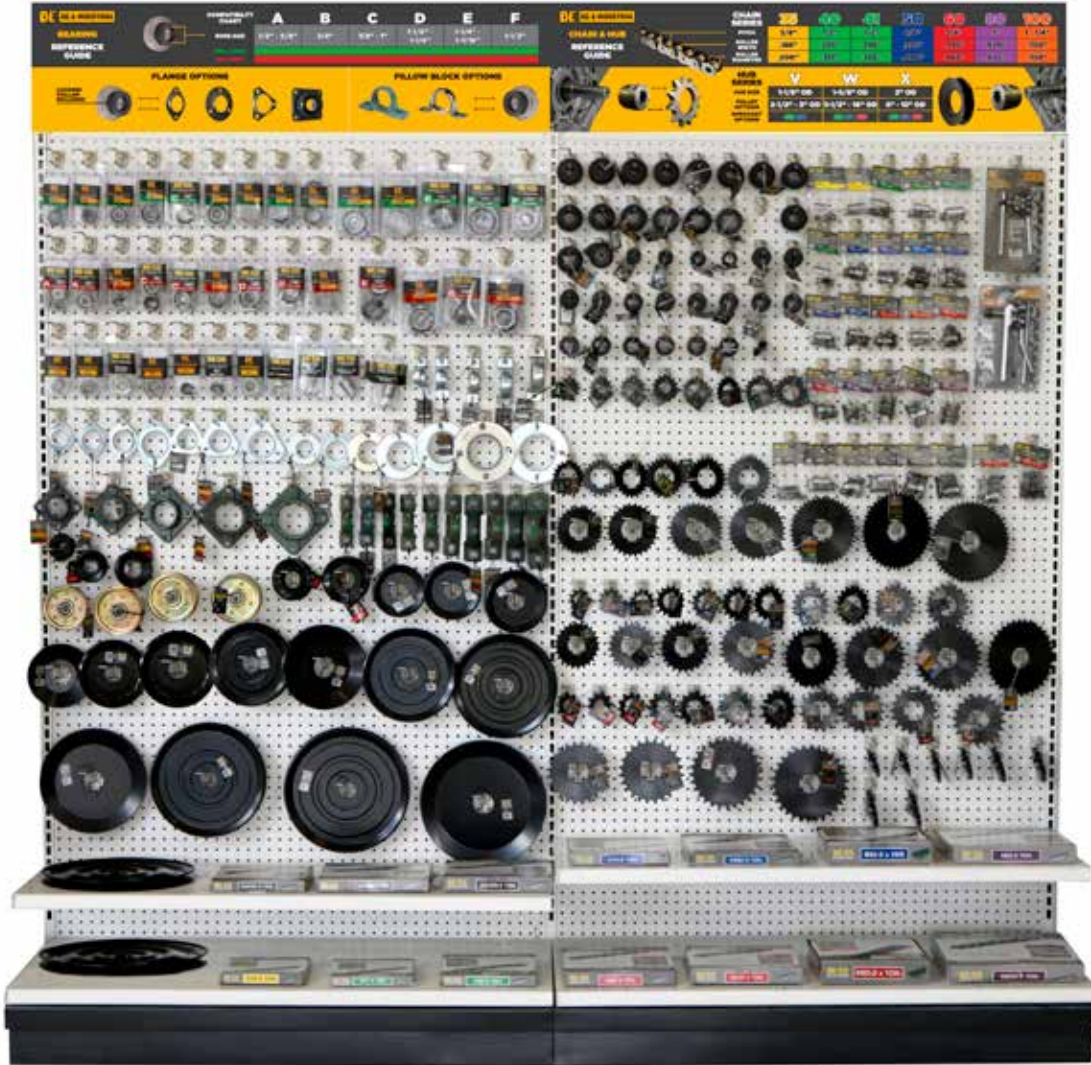

**DESIGNED TO WORK WITH
STANDARD LOZIER SHELVING UNITS**

**COLOR CODING & ALPHABETICAL
SYSTEM SIMPLIFIES AND MAKES PROGRAM
CONSUMER FRIENDLY**

**CONTACT US TODAY FOR INFORMATION AND PRICING ON OUR POWER TRANSMISSION PROGRAM.
RECEIVE THE MERCHANDISERS FREE WITH THE PURCHASE OF THE COMPLETE PROGRAM.**

MATCHING HUBS & BORES TO PULLEYS & SPROCKETS



MATCHING HUBS & PULLEYS

Step 1:

Select a pulley (page 253) based on the outside diameter and belt type you require. Note the hub type (ie: Bolt size A/B or C).

Step 2:

Select the hub you require (page 252) based on the configuration and diameter of the output shaft it will be installed on. The hub type must match the hub type listed for the pulley on page 253.

MATCHING HUBS & SPROCKETS

Step 1:

Select a sprocket (page 254-255) based on the chain size and the number of teeth you require. Note the hub type (ie: V/W/X).

Step 2:

Select the hub you require (page 252) based on the configuration and diameter of the output shaft it will be installed on. The hub type must match the hub type listed for the sprocket on page 254 or 255.

Step 3:

Using the color code, match the chain pitch (page 198) to the sprocket. Then match the color code and chain type to find the correct connecting and offset links (page 256).

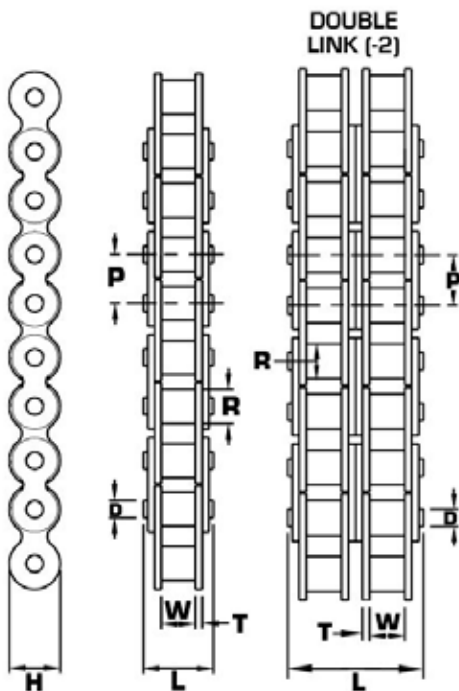

ANSI STANDARDS

CHAIN #	PITCH P	ROLLER		PIN		LINK PLATES		TENSILE STRENGTH LBS	WT. LBS/ FT
		R	W	D	L	T	H		
35	3/8	0.200	3/16	0.141	0.500	0.050	0.350	2100	0.21
41	1/2	0.306	1/4	0.141	0.578	0.050	0.383	2000	0.25
40	1/2	0.312	5/16	0.156	0.695	0.060	0.466	3700	0.42
50	5/8	0.400	3/8	0.200	0.855	0.080	0.584	6100	0.69
60	3/4	0.468	1/2	0.234	1.081	0.094	0.700	8500	1.00
80	1	0.625	5/8	0.312	1.378	0.125	0.934	14500	1.71
100	1-1/4	0.750	3/4	0.375	1.701	0.156	1.166	24000	2.58
120	1-1/2	0.875	1	0.437	2.130	0.187	1.400	34000	3.87
50H	5/8	0.400	3/8	0.200	0.922	0.094	0.571	7500	0.80
60H	3/4	0.468	1/2	0.234	1.185	0.125	0.700	8500	1.22
80H	1	0.625	5/8	0.312	1.504	0.156	0.934	14500	2.03
35-2	3/8	0.200	3/16	0.141	0.900	0.050	0.350	4200	0.40
40-2	1/2	0.312	5/16	0.156	1.259	0.060	0.466	7400	0.82
50-2	5/8	0.400	3/8	0.200	1.585	0.080	0.584	12200	1.36
60-2	3/4	0.468	1/2	0.234	1.985	0.094	0.700	17000	1.99
80-2	1	0.625	5/8	0.312	2.536	0.125	0.934	29000	3.40
100-2	1-1/4	0.750	3/4	0.375	3.107	0.156	1.166	48000	5.10
120-2	1-1/2	0.875	1	0.437	3.921	0.187	1.400	68000	7.65
A2040	1	0.312	5/16	0.156	0.630	0.060	0.466	3700	0.30
A2050	1-1/4	0.400	3/8	0.200	0.790	0.080	0.584	6100	0.50
A2060	1-1/2	0.468	1/2	0.234	0.990	0.094	0.700	8500	0.70

V HUB - ROUND BORE

72.100.012



PART#	BORE SIZE	HUB TYPE
72.100.012	1/2"	V
72.100.916	9/16"	V
72.100.058	5/8"	V
72.100.034	3/4"	V
72.100.078	7/8"	V

W HUB - SPLINED BORE

72.206.138



PART#	BORE SIZE	HUB TYPE
72.206.118	1-1/8" X 6 SP	W
72.206.138	1-3/8" X 6 SP	W

X HUB - HEX BORE

72.320.078



PART#	BORE SIZE	HUB TYPE
72.320.078	7/8"	X
72.320.100	1"	X
72.320.118	1-1/8"	X

W HUB - ROUND BORE

72.200.034



W HUB - HEX BORE

72.220.078



PART#	BORE SIZE	HUB TYPE
72.220.078	7/8"	W
72.220.100	1"	W

X HUB - SPLINED BORE

72.306.118



PART#	BORE SIZE	HUB TYPE
72.306.118	1-1/8" X 6 SP	X
72.321.138	1-3/8" X 21 SP	X
72.306.138	1-3/8" X 6 SP	X

PART#	BORE SIZE	HUB TYPE
72.200.012	1/2"	W
72.200.916	9/16"	W
72.200.058	5/8"	W
72.201.116	11/16"	W
72.200.034	3/4"	W
72.201.316	13/16"	W
72.200.078	7/8"	W
72.201.516	15/16"	W
72.210.000	1"	W
72.210.116	1-1/16"	W
72.210.018	1-1/8"	W
72.210.316	1-3/16"	W
72.210.014	1-1/4"	W

X HUB - ROUND BORE

72.300.058



PART#	BORE SIZE	HUB TYPE
72.300.058	5/8"	X
72.301.116	11/16"	X
72.300.034	3/4"	X
72.301.316	13/16"	X
72.300.078	7/8"	X
72.301.516	15/16"	X
72.310.000	1"	X
72.310.116	1-1/16"	X
72.310.118	1-1/8"	X
72.310.316	1-3/16"	X
72.310.014	1-1/4"	X
72.310.516	1-5/16"	X
72.310.038	1-3/8"	X
72.310.716	1-7/16"	X
72.310.012	1-1/2"	X

X - HUB - SQUARE BORE

72.330.058



PART#	BORE SIZE	HUB TYPE
72.330.058	5/8"	X
72.330.078	7/8"	X
72.330.118	1-1/8"	X
72.331.316	1-3/16"	X

W HUB - SQUARE

72.230.012



PART#	BORE SIZE	HUB TYPE
72.230.012	1/2"	W
72.230.034	3/4"	W

IDLER HUB

72.212.058



PART#	BORE SIZE	HUB TYPE
72.212.058	5/8" - 1/2"	W
72.312.058	5/8" - 1/2"	X

PULLEYS - WELD-ON & IDLER

V BELT PULLEY
75.100.003



PART#	OD	BELT STYLE	HUB TYPE
75.100.212	2-1/2"	A OR B	V
75.100.003	3"	A OR B	V

W BELT PULLEY
75.200.312



PART#	OD	BELT STYLE	HUB TYPE
75.200.312	3-1/2"	A OR B	W
75.200.004	4"	A OR B	W
75.200.412	4-1/2"	A OR B	W
75.200.005	5"	A OR B	W
75.200.512	1/2"	A OR B	W
75.200.006	6"	A OR B	W
75.200.612	6-1/2"	A OR B	W
75.200.007	7"	A OR B	W
75.200.008	8"	A OR B	W
75.200.009	9"	A OR B	W
75.200.010	10"	A OR B	W
75.200.011	11"	A OR B	W
75.200.012	12"	A OR B	W
75.200.014	14"	A OR B	W
75.200.016	16"	A OR B	W

X BELT PULLEY
75.300.006



PART#	OD	BELT STYLE	HUB TYPE
75.300.006	6"	C	X
75.300.008	8"	C	X
75.300.010	10"	C	X
75.300.012	12"	C	X

FLAT TYPE IDLER PULLEY
75.850.303



PART#	OD	BORE SIZE	INSIDE WIDTH
75.850.303	1-7/8"	3/8"	3/4"
75.850.304	2-1/4"	3/8"	1"
75.850.305	2-3/4"	5/8"	7/8"
75.850.307	3-1/2"	5/8"	1"
75.850.308	4"	5/8"	3/4"
75.850.301	4"	1/2"	1"
75.850.302	4"	5/8"	1"

- Full range of sizes to suit most industry needs
- High Quality and Precision Machined
- Weld-on pulleys to be used in combination with multiple sizes of weld-on hubs

IDLER SPROCKET

74.401.217



PART#	CHAIN	BORE SIZE	TEETH	COLOR
74.401.217	#40/41	1/2"	17	GREEN
74.405.817	#40/41	5/8"	17	GREEN
74.501.213	#50	1/2"	13	BLUE
74.505.813	#50	5/8"	13	BLUE
74.501.215	#50	1/2"	15	BLUE
74.505.815	#50	5/8"	15	BLUE
74.501.217	#50	1/2"	17	BLUE
74.505.817	#50	5/8"	17	BLUE
74.601.211	#60	1/2"	11	RED
74.605.811	#60	5/8"	11	RED
74.601.213	#60	1/2"	13	RED
74.605.813	#60	5/8"	13	RED
74.601.215	#60	1/2"	15	RED
74.605.815	#60	5/8"	15	RED

#40 SPROCKET 1/2" PITCH - V

74.040.015



PART#	CHAIN	OD	TEETH	HUB	COLOR
74.040.012	# 40	2-3/16"	12	V	GREEN
74.040.013	# 40	2-1/4"	13	V	GREEN
74.040.014	# 40	2-7/16"	14	V	GREEN
74.040.015	# 40	2-5/8"	15	V	GREEN

#40 SPROCKET 1/2" PITCH - X

74.040.020



PART#	CHAIN	OD	TEETH	HUB	COLOR
74.040.020	# 40	3-7/16"	20	X	GREEN
74.040.021	# 40	3-5/8"	21	X	GREEN
74.040.022	# 40	3-3/4"	22	X	GREEN
74.040.023	# 40	4"	23	X	GREEN
74.040.024	# 40	4-1/6"	24	X	GREEN
74.040.026	# 40	4-3/8"	26	X	GREEN
74.040.028	# 40	4-11/16"	28	X	GREEN
74.040.030	# 40	5-1/16"	30	X	GREEN
74.040.032	# 40	5-3/8"	32	X	GREEN
74.040.036	# 40	6"	36	X	GREEN
74.040.040	# 40	6-5/8"	40	X	GREEN
74.040.042	# 40	7"	42	X	GREEN
74.040.045	# 40	7-3/8"	45	X	GREEN
74.040.048	# 40	7-7/8"	48	X	GREEN

#40 SPROCKET 1/2" PITCH - W

74.040.016



PART#	CHAIN	OD	TEETH	HUB	COLOR
74.040.016	# 40	2-13/16"	16	W	GREEN
74.040.017	# 40	3"	17	W	GREEN
74.040.018	# 40	3-1/8"	18	W	GREEN
74.040.019	# 40	3-5/16"	19	W	GREEN

- Made of high quality, precision machined steel for long lasting performance
- Offered in a full line of weld-on or idler sprockets
- Weld-on sprockets to be used in combination with multiple sizes of weld-on hubs

#50 SPROCKET 5/8" PITCH - V

74.050.010



PART#	CHAIN	OD	TEETH	HUB	COLOR
74.050.010	#50	2-1/4"	10	V	BLUE
74.050.011	#50	2-1/2"	11	V	BLUE

#50 SPROCKETS 5/8" PITCH - W

74.050.012



PART#	CHAIN	OD	TEETH	HUB	COLOR
74.050.012	#50	2-3/4"	12	W	BLUE
74.050.013	#50	2-7/8"	13	W	BLUE
74.050.014	#50	3-1/16"	14	W	BLUE
74.050.015	#50	3-1/4"	15	W	BLUE
74.050.016	#50	3-7/16"	16	W	BLUE

#50 SPROCKET 5/8" PITCH

74.050.017



PART#	CHAIN	OD	TEETH	HUB	COLOR
74.050.017	#50	3-11/16"	17	X	BLUE
74.050.018	#50	3-7/8"	18	X	BLUE
74.050.019	#50	4-1/8"	19	X	BLUE
74.050.020	#50	4-3/8"	20	X	BLUE
74.050.021	#50	4-9/16"	21	X	BLUE
74.050.022	#50	4-3/4"	22	X	BLUE
74.050.024	#50	5-1/8"	24	X	BLUE
74.050.026	#50	5-1/2"	26	X	BLUE
74.050.028	#50	5-7/8"	28	X	BLUE
74.050.030	#50	6-5/16"	30	X	BLUE
74.050.032	#50	6-3/4"	32	X	BLUE
74.050.034	#50	7-1/16"	34	X	BLUE
74.050.036	#50	7-9/16"	36	X	BLUE

#60 SPROCKET 3/4" PITCH - V

74.060.009



PART#	CHAIN	OD	TEETH	HUB	COLOR
74.060.009	#60	2-1/2"	9	V	RED
74.060.010	#60	2-3/4"	10	V	RED

#60 SPROCKET 3/4" PITCH - W

74.060.011



PART#	CHAIN	OD	TEETH	HUB	COLOR
74.060.011	#60	3"	11	W	RED
74.060.012	#60	3-1/4"	12	W	RED
74.060.013	#60	3-1/2"	13	W	RED
74.060.014	#60	3-3/4"	14	W	RED

#60 SPROCKET 3/4" PITCH - X

74.060.015



PART#	CHAIN	OD	TEETH	HUB	COLOR
74.060.015	#60	4"	15	X	RED
74.060.016	#60	4-1/4"	16	X	RED
74.060.017	#60	4-1/2"	17	X	RED
74.060.018	#60	4-11/16"	18	X	RED
74.060.019	#60	5"	19	X	RED
74.060.020	#60	5-1/8"	20	X	RED
74.060.021	#60	5-1/2"	21	X	RED
74.060.022	#60	5-11/16"	22	X	RED
74.060.024	#60	6-1/8"	24	X	RED
74.060.026	#60	6-5/8"	26	X	RED
74.060.028	#60	7-1/8"	28	X	RED
74.060.030	#60	7-5/8"	30	X	RED

ROLLER CHAIN, LINKS & TOOLS

HIGH QUALITY AND PRECISION MACHINED STEEL TO MEET OR EXCEED ANSI SPECIFIED STANDARDS
OFFERED IN BAGGED QUANTITIES FOR CONVENIENCE

CONNECTING LINKS

65.040.001



OFFSET LINKS

65.050.002



PART#	TYPE	BAG QTY	PITCH	COLOR
65.204.001	A2040	4	1"	BLACK
65.205.001	A2050	3	1-1/4"	BLACK
65.206.001	A2060	3	1-1/2"	BLACK
65.035.001	35	4	3/8"	YELLOW
65.035.201	35-2	4	3/8"	YELLOW
65.040.001	40	4	1/2"	GREEN
65.041.001	41	4	1/2"	GREEN
65.050.001	50	4	5/8"	BLUE
65.050.201	50-2	4	5/8"	BLUE
65.050.501	50H	4	5/8"	BLUE
65.060.001	60R	3	3/4"	RED
65.060.201	60-2	3	3/4"	RED
65.060.501	60H	3	3/4"	RED
65.080.001	80	2	1"	PURPLE
65.080.201	80-2	2	1"	PURPLE
65.080.501	80H	2	1"	PURPLE
65.100.001	100	2	1-1/4"	ORANGE
65.120.001	120	2	1-1/2"	BROWN

PART#	TYPE	BAG QTY	PITCH	COLOR
65.204.002	A2040	4	1"	BLACK
65.205.002	A2050	3	1-1/4"	BLACK
65.206.002	A2060	3	1-1/2"	BLACK
65.035.002	35	4	3/8"	YELLOW
65.035.202	35-2	4	3/8"	YELLOW
65.040.002	40	4	1/2"	GREEN
65.041.002	41	4	1/2"	GREEN
65.050.002	50	3	5/8"	BLUE
65.050.202	50-2	3	5/8"	BLUE
65.050.502	50H	3	5/8"	BLUE
65.060.002	60R	3	3/4"	RED
65.060.202	60-2	3	3/4"	RED
65.060.502	60	3	3/4"	RED
65.080.002	80	2	1"	PURPLE
65.080.202	80-2	2	1"	PURPLE
65.080.502	80	2	1"	PURPLE
65.100.002	100R	2	1-1/4"	ORANGE
65.120.002	120R	2	1-1/2"	BROWN

ROLLER CHAIN BREAKER PIN BREAKER #25 - #60 CHAIN

67.005.050



ROLLER CHAIN BREAKER PIN BREAKER #60 - #100 CHAIN

67.005.051



ROLLER CHAIN

65.050.010



PART#	TYPE	LENGTH	PITCH	COLOR
65.204.010	2040	10'	1"	BLACK
65.205.010	2050	10'	1-1/4"	BLACK
65.206.010	2060	10'	1-1/2"	BLACK
65.035.010	35	10'	3/8"	YELLOW
65.035.210	35-2	10'	3/8"	YELLOW
65.040.010	40	10'	1/2"	GREEN
65.041.010	41	10'	1/2"	GREEN
65.050.010	50	10'	5/8"	BLUE
65.050.210	50-2	10'	5/8"	BLUE
65.050.510	50H	10'	5/8"	BLUE
65.060.010	60R	10'	3/4"	RED
65.060.210	60-2	10'	3/4"	RED
65.060.510	60H	10'	3/4"	RED
65.080.010	80R	10'	1"	PURPLE
65.080.510	80H	10'	1"	PURPLE
65.100.010	100	10'	1-1/4"	ORANGE
65.120.010	120	10'	1-1/2"	BROWN

DRIVE PRODUCT - CAST BEARING HOUSING

4 BOLT FLANGE HOUSING

33.207.000FS



PART#	DESCRIPTION	COLOR		TYPE
33.204.000FS	1/2" - 3/4"	GREEN	RED	B
33.205.000FS	7/8" - 1"	GREEN	RED	C
33.206.000FS	1-1/8" - 1-1/4"	GREEN	RED	D
33.207.000FS	1-1/4" - 1-7/16"	GREEN	RED	E
33.208.000FS	1-1/2" - 1-9/16"	GREEN	RED	F

LOW PROFILE PILLOW BLOCK HOUSING

33.204.000LP



PART#	BORE SIZE	COLOR		TYPE
33.204.000LP	3/4"	GREEN	RED	B
33.205.000LP	7/8" - 1"	GREEN	RED	C
33.206.000LP	1-1/8" - 1-1/4"	GREEN	RED	D
33.207.000LP	1-1/4" - 1-7/16"	GREEN	RED	E

PILLOW BLOCK HOUSING

33.203.000P



PART#	BORE SIZE	COLOR		TYPE
33.203.000P	1/2" - 11/16"	GREEN	RED	A
33.204.000P	3/4"	GREEN	RED	B
33.205.000P	7/8" - 1"	GREEN	RED	C
33.206.000P	1-1/8" - 1-1/4"	GREEN	RED	D
33.207.000P	1-1/4" - 1-7/16"	GREEN	RED	E
33.208.000P	1-1/2" - 1-9/16"	GREEN	RED	F

- High quality, precision machined steel
- Meets or exceeds ANSI specified standards
- Solid rollers, solid bushings
- Offered in a complete line of sizes to suit all needs

**STAMPED STEEL
3 & 4 BOLT FLANGE**
33.203.000PF



PART#	DESCRIPTION	BORE SIZE	COLOR		TYPE
33.203.000PF	3 HOLE ROUND	1/2" - 1-1/16"	GREEN	RED	A
33.204.000PF	3 HOLE ROUND	3/4"	GREEN	RED	B
33.205.000PF	3 HOLE ROUND	7/8" - 1"	GREEN	RED	C
33.206.000PF	3 HOLE ROUND	1-1/8" - 1-1/4"	GREEN	RED	D
33.207.000PF	3 HOLE ROUND	1-1/4" - 1-7/16"	GREEN	RED	E
33.208.004PF	4 HOLE ROUND	1-1/2" - 1-9/16"	GREEN	RED	F
33.209.004PF	4 HOLE ROUND	1-5/8" - 1-3/4"	GREEN	RED	G

**STAMPED STEEL
2 BOLT FLANGE**
33.203.000PFL



PART#	DESCRIPTION	BORE SIZE	COLOR		TYPE
33.203.000PFL	2 HOLE	1/2" - 1-1/16"	GREEN	RED	A
33.204.000PFL	2 HOLE	3/4"	GREEN	RED	B
33.205.000PFL	2 HOLE	7/8" - 1"	GREEN	RED	C
33.206.000PFL	2 HOLE	1-1/8" - 1-1/4"	GREEN	RED	D

**STAMPED STEEL
3 BOLT FLANGE**
33.204.000GPFL



PART#	DESCRIPTION	BORE SIZE	COLOR		TYPE
33.204.000GPFL	3 HOLE TRIANGLE	3/4"	GREEN	RED	B
33.205.000GPFL	3 HOLE TRIANGLE	7/8" - 1"	GREEN	RED	C
33.206.000GPFL	3 HOLE TRIANGLE	1-1/8" - 1-1/4"	GREEN	RED	D

**STAMPED STEEL
PILLOW BLOCK FLANGE**
33.203.000PP



PART#	DESCRIPTION	COLOR		TYPE
33.203.000PP	1/2" - 1-1/16"	GREEN	RED	A
33.204.000PP	3/4"	GREEN	RED	B
33.205.000PP	7/8" - 1"	GREEN	RED	C
33.206.000PP	1-1/8" - 1-1/4"	GREEN	RED	D
33.207.000PP	1-1/4" - 1-7/16"	GREEN	RED	E

PRESS WHEEL BEARING

33.007.032RS



5/8" BEARING
29.062.002BP



CULTIVATOR & PUMP BEARINGS

PART#	DESCRIPTION	COLOR
33.007.032RS	PRESS WHEEL BEARING	BLACK
31.062.002BP	BEARING 5/8"	BLACK
29.062.002BP	PUMP BEARING 15 MM .5906	BLACK
29.062.003BP	PUMP BEARING 17 MM .6693	BLACK
29.062.004BP	PUMP BEARING 20 MM .7874	BLACK
29.062.005BP	PUMP BEARING 25 MM .9843	BLACK
33.885.151E	BEARING IHC CULTIVATOR GAUGE WHEEL	BLACK
33.885.154B	CULT GAUGE WHEEL BEARING	BLACK
33.099.502H	BEARING FOR ACE PUMP 15.88 MM 5/8"	BLACK
33.009.504ZRST	CULTIVATOR BEARING 3/4"	BLACK

PRE-LUBED BEARING

33.201.008SA



PART#	BORE SIZE	COLOR	TYPE
33.201.008SA	1/2"	GREEN	A
33.202.010SA	5/8"	GREEN	A
33.204.012SA	3/4"	GREEN	B
33.205.014SA	7/8"	GREEN	C
33.205.015SA	15/16"	GREEN	C
33.205.016SA	1"	GREEN	C
33.206.018SA	1-1/8"	GREEN	D
33.206.019SA	1-3/16"	GREEN	D
33.206.020SA	1-1/4"	GREEN	D
33.207.020SA	1-1/4"	GREEN	E
33.207.022SA	1-3/8"	GREEN	E
33.207.023SA	1-7/16"	GREEN	E
33.208.024CSA	1-1/2"	GREEN	F
33.208.000WPPB7		GREEN	F

RE-LUBED BEARINGS

33.201.008HC



PART#	BORE SIZE	COLOR	TYPE
33.201.008HC	1/2"	RED	A
33.202.010HC	5/8"	RED	A
33.204.012HC	3/4"	RED	B
33.205.014HC	7/8"	RED	C
33.205.015HC	15/16"	RED	C
33.205.016HC	1"	RED	C
33.206.018HC	1-1/8"	RED	D
33.206.019HC	1-3/16"	RED	D
33.206.020HC	1-1/4"	RED	D
33.207.020HC		RED	E
33.207.022HC	1-3/8"	RED	E
33.207.023HC	1-7/16"	RED	E
33.208.024HC	1-1/2"	RED	F

**EARTH ANCHOR
HOT DIPPED GALVANIZED**
62.000.004

- Orchard & vineyard anchors
- Hot dipped electro galvanized finish

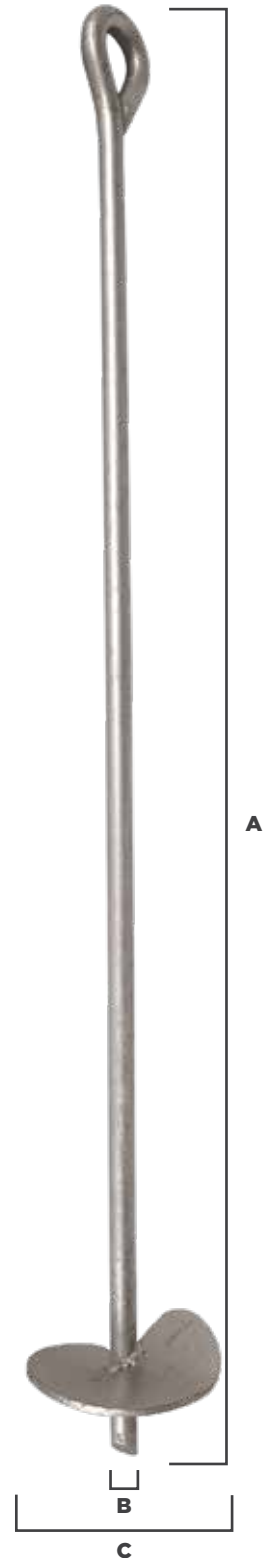
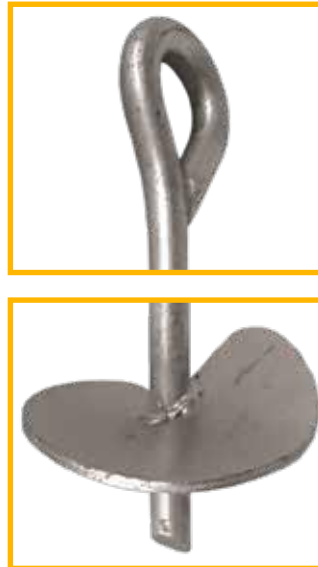
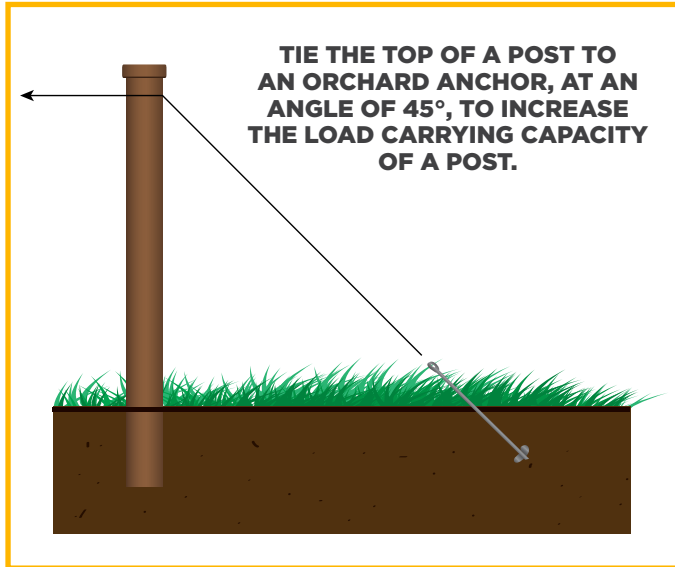

PART#	A	B	C
62.000.004	48"	5/8"	6"
62.000.006	48"	5/8"	4-1/2"
62.000.007	36"	1/2"	4-1/2"
62.000.008	36"	5/8"	6"
62.000.009	28"	1/2"	3"
62.000.010	15-1/2"	1/2"	3"

TIE-OUT STAKE
15" LONG, 3/8" THICK
62.000.012



INCLUDES KEY RING



SQUARE BALE COVER ANCHOR
PLASTIC (7-2/3" - 3-3/16")
62.000.020



RANCH HARDWARE - FENCE PRODUCT

**GATE CLOSER
HEAVY DUTY CABLE**
71.000.010



- A quick, yet effective way to open/close gates
- Adjustable cable can be sized to fit around most size posts
- Easy and quick to install on any wooden fence post

**GATE CLOSER
CABLE**
71.000.008



**GATE ANCHOR
FITS 1-3/4" - 2" TUBE**
71.000.005



- Drop down anchor when gate is in any position to keep from moving
- Prevent sagging and swinging with this easy to install gate anchor

**GATE LATCH
1-5/8" - 2" TUBE
ONE WAY LOCKABLE**
71.002.007



- Reduce stress on gate hinge and prevent sagging and swinging
- Quickly open latch with only one hand
- Lockable, for extra security

**GATE HINGE
1-5/8" - 1-3/4" TUBE GATES**
71.002.001

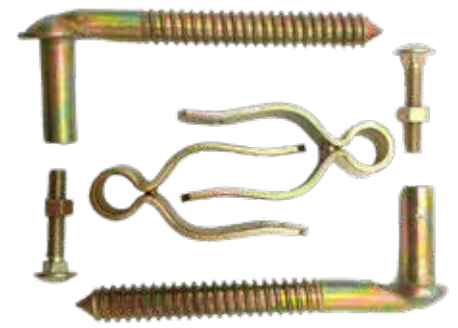

- Includes both upper and lower mounting hardware
- Simple to install and reliable quality

**GATE LATCH
1-5/8" - 2" TUBE
TWO WAY LOCKABLE**
71.002.010



- Reduce stress on gate hinge and prevent sagging and swinging
- Quickly open latch with only one hand
- Lockable, for extra security

**GATE HINGE
2" TUBE GATES**
71.002.002

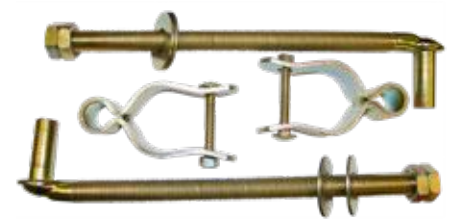

- Includes both upper and lower mounting hardware
- Simple to install and reliable quality

GATE WHEEL
71.003.400



- Fits round tube 1-5/8" - 2" OD
- Allows gate to open and close easily in either direction
- Prevents gate from swinging and sagging

TALL GATE WHEEL
FITS 1-5/8" - 2" TUBE
71.003.000



- Height adjustable mounting system for different height gates
- Reduce stress on gate hinge and bolts, and allow the gate to open with ease
- Easy to install

FLAT FREE SLIDING GATE WHEEL
71.003.200



- Constructed of zinc plated, rust resistant steel
- Two foam filled, flat free tires prevent sagging or dragging when the gate rolls open
- U-bolts attach wheels to 2" - 3" diameter tube.

FLAT FREE SUSPENSION GATE WHEEL
71.003.100



- Castors are designed to make gate opening and closing easy
- Integrated extended gate mount allows full 360° rotation of wheel
- Spring-loaded design provides shock absorption
- U-bolts (included) attach wheel to 1-5/8" - 2" diameter tube
- 10" wheel diameter

XTRAC PLASTIC GATE WHEEL
71.003.300



- Dual mounting positions to accommodate high or low gates.
- Includes heavy duty axle bolt with locking nut and 3 U-bolts with nuts.
- Large wheel allows gate to swing over rough, muddy or uneven entries and helps gate float across rough or wet driveways.
- Black powder coat finish prevents rust and weathering.
- Supports up to a 300 lb gate.

RANCH HARDWARE - FENCE PRODUCT

8' STUDDED T-POST
71.004.008



8'

SPRING LOADED POST POUNDER
71.004.003

- Drive steel fence posts into the ground with ease
- Heavy duty steel & powder coated finish make for a long lasting life



POST POUNDER
71.004.002 AVAILABLE ONLY IN CANADA
71.004.002R AVAILABLE ONLY IN USA

- Drive steel fence posts into the ground with ease
- Heavy duty steel & powder coated finish make for a long lasting life



T-POST PULLER
71.004.000



- Pull T-posts out of the ground & keep them straight & in re-usable condition
- Long handle gives extra leverage
- Makes for a simple & effective one person operation

T-POST PULLER
71.004.001



- Pull T-posts out of the ground & keep them straight & in re-usable condition
- Can be used with farm jack or chain with hook

WIRE GRIPPER
71.000.011



- Safely grip and hold barbed wire when doing maintenance
- Works with other small cables or wires
- For use with a come-along

WIRE STRETCHER
36" WOVEN
71.000.017



- A simple, efficient tool to stretch woven and welded wire fence
- Just attach hooks to fence and cable puller to loop to start stretching

BARBED WIRE CARRIERS
71.000.012



- Grip and carry rolls of barbed wire safely
- Can also be used to easily unroll barbed wire with its free spinning design

RATCHETING WIRE STRETCHER
71.000.015



- Safely hold and keep tension on wire when connecting

RATCHETING WIRE STRETCHER WITH CONTROLLED RELEASE
71.000.020



- With controlled release ratchet

**COW BELL
RED HANDLE**
71.500.000



- Powder coated finish for long life
- Great for sporting events!

**COW BELL
4" LONG DISTANCE**
71.500.001



- Long distance cowbells produce a sharp tone that can be heard at long distances

HAY HOOK 11" RED
71.000.013

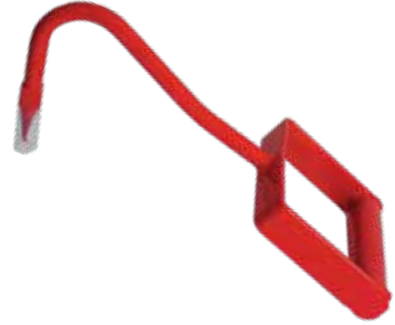

**COW BELL
1-5/8" KENTUCKY**
71.500.005

- Kentucky cowbells produce a dull tone that can be heard at long distances

**COW BELL
3-3/4" KENTUCKY**
71.500.004



**COW BELL
4-7/8" KENTUCKY**
71.500.003

HAY HOOK 17" RED
71.000.016



- Move and secure bales of hay easier with hay hooks
- Wide handle makes this the ideal hay bucking tool

**16" TOOL BOX
TRACTOR RED PORTABLE**
67.500.016



**20" TOOL BOX
TRACTOR RED PORTABLE**
67.500.020



- Mount and dismount tool box with ease whenever needed.
- Includes mounting hardware to mount to tractor or other equipment.
- Sturdy steel construction



DIESEL TRANSFER TANK

DIESEL TRANSFER TANK
DD400

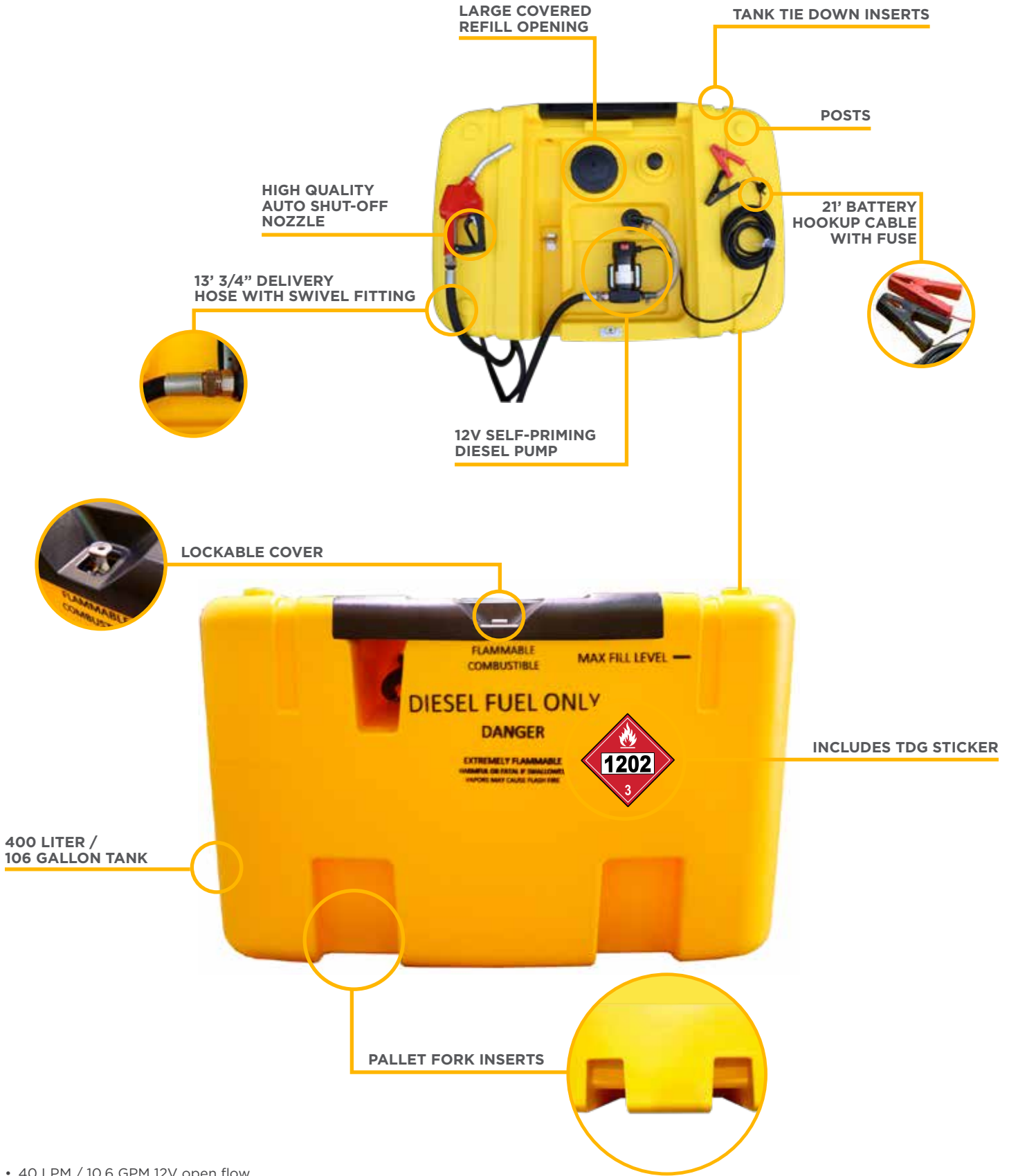

- 40 LPM / 10.6 GPM 12V open flow
- Size: 1150 mm x 880 mm x 680 mm (45.5" x 32" x 27")
- Weight: 53 kg / 116 lbs

36" JOB BOX WITH ONE CYLINDER STRUT JB36



- Easy operation with cylinder struts
- 16 gauge steel construction
- MIG welded seams for extra durability
- Tamper-proof locking system keeps tools safe
- Recessed industrial strength side handles
- Heavy duty locking hinge provides extra lid strength
- Rust and scratch resistant durable powder coat finish



TB30

PART#	SIZE	CYLINDER STRUTS	OVERALL SIZE
TB30	30"	N/A	30" X 12" X 16"
JB36	36"	1	36" X 17.3" X 22"
JB48	48"	2	48" X 24.4" X 27.9"

3-IN-1 JOB BOX SET 30", 36" & 48" JB30-48



- Easy operation with cylinder struts
- 16 gauge steel construction
- MIG welded seams for extra durability
- Tamper-proof locking system keeps tools safe
- Recessed industrial strength side handles
- Heavy duty locking hinge provides extra lid strength
- Rust and scratch resistant durable powder coat finish



**BUY ALL 3
AS A SET
AND SAVE!**

BOOSTER CABLES



ZIPPED BAG



BOXED



PARROT CLAMPS



ALLIGATOR CLAMPS

UNIVERSAL BATTERY TERMINALS ZINC, 2 PACK
67.999.005

UNIVERSAL BATTERY TERMINALS LEAD, 2 PACK
67.999.006

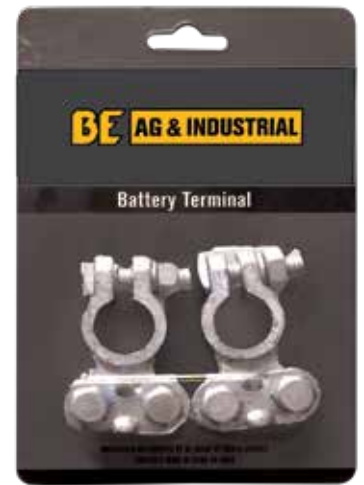

COPPER/ALUMINUM BOOSTER CABLES

PART#	GAUGE	LENGTH	CLAMP STYLE	CLAMP AMP	COATING	CABLE MATERIAL	PACKAGING
BE128BC	8	12'	ALLIGATOR	250	HIGH FLEX	COPPER/ALUMINUM	ZIPPED BAG
BE126BC	6	12'	PARROT	500	HIGH FLEX	COPPER/ALUMINUM	ZIPPED BAG
BE124BC	4	12'	PARROT	500	HIGH FLEX	COPPER/ALUMINUM	BOXED
BE164BC	4	16'	PARROT	500	HIGH FLEX	COPPER/ALUMINUM	BOXED
BE204BC	4	20'	PARROT	500	HIGH FLEX	COPPER/ALUMINUM	BOXED
BE202BC	2	20'	PARROT	500	HIGH FLEX	COPPER/ALUMINUM	BOXED

ALL COPPER BOOSTER CABLE

PART#	GAUGE	LENGTH	CLAMP STYLE	CLAMP AMP	COATING	CABLE MATERIAL	PACKAGING
BE252BC	2	25'	PARROT	500	HIGH FLEX	ALL COPPER	BOXED



FARM JACK
48"
FJ-48

FARM JACK
60"
FJ-60



FEATURES

- Farm, lift, hoist, pull or push
- Top winch-connector clamp
- Safe use information is fixed to jack handle tube for easy reference

APPLICATIONS

- Multi-purpose jack for off road, winching, pulling/clamping & agricultural applications

PART#	RATED CAPACITY	TESTED CAPACITY	HEIGHT	LIFT RANGE	CLAMPING CAPACITY	WINCHING CAPACITY
FJ-48	4660 LBS	7000 LBS	48"	4-1/2" - 37"	750 LBS	5000 LBS
FJ-60	4660 LBS	7000 LBS	60"	4-1/2" - 48-1/4"	750 LBS	5000 LBS

ACCESSORIES AVAILABLE

PART#	DESCRIPTION
FJ-FP	FARM JACK FOOT PLATE

- Reduces jack sinkage on soft ground
- Convenient to use, easy to store
- Can be used with FJ-48 & FJ-60
- Durable foot plate increases support surface area and gives the jack more versatility



SOMETHING EXCITING IS HERE

BE'S NEW RANGE OF LIFTING EQUIPMENT HAS BEEN DESIGNED TO NOT ONLY MEET BUT EXCEED THE REQUIREMENTS AND DEMANDS OF WORKING PROFESSIONALS.

BUILT WITH THICKER GAUGE STEEL, HEAVIER DUTY NUTS & BOLTS AND HIGHER QUALITY SEALS AND WHEELS THAN THE COMPETITION, YOU'LL HAVE THE CONFIDENCE TO LIFT WITH **BE** WHETHER IN THE GARAGE OR ON THE FARM.

BACKED BY **BE'S** 1 & 2 YEAR WARRANTY AGAINST MANUFACTURING DEFECTS.

BE LIFTING EQUIPMENT



AUTOMOTIVE
VEHICLES



OFF-ROAD
VEHICLES



MOTORCYCLES



SNOWMOBILES



BUSES



CONSTRUCTION
EQUIPMENT



FARM & GARDEN
VEHICLES



HEAVY
TRUCKS

WORKSHOP

SERIES

PROFESSIONAL

SERIES



2 - 3-1/2 TON HYDRAULIC FLOOR JACKS

- Built In Small Parts Tray
- Built-in safety valve protects against jack over-loading
- Hydraulic oil by-pass system protects ram from being over-extended
- "Quick Start" double pump technology for fast operation to contact point



TWIN PISTON PUMP



SWIVEL REAR HEAVY DUTY CASTOR WHEELS



HEAVY DUTY RUBBER SADDLE PAD



KNURLED HANDLE WITH FOAM SLEEVE

PROFESSIONAL

SERIES



AUTOMOTIVE VEHICLES



OFF-ROAD VEHICLES



FARM & GARDEN VEHICLES



PART NO.	35.400.102	35.400.002	35.400.035
CAPACITY	2 TON (LOW PROFILE)	2 TON	3-1/2 TON
MIN HEIGHT	2.7"	4.4"	5.2"
MAX HEIGHT	24"	20"	21"
TOTAL LIFT	21.3"	15.6"	15.8"

3 TON HYDRAULIC FLOOR JACK / JACK STANDS COMBO KIT

- Built In Small Parts Tray
- Built-in safety valve protects against jack over-loading
- Hydraulic oil by-pass system protects ram from being over-extended
- "Quick Start" double pump technology for fast operation to contact point

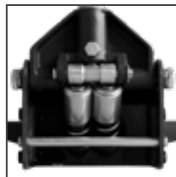

TWIN PISTON PUMP



SWIVEL REAR HEAVY DUTY CASTOR WHEELS



DUCTILE IRON RATCHET BAR



LOCKING PAWL WITH BUILT-IN COUNTER WEIGHT



HEAVY DUTY RUBBER SADDLE PAD



KNURLED HANDLE WITH FOAM SLEEVE



WELDED DESIGN



WIDE BASE

PROFESSIONAL

SERIES



AUTOMOTIVE VEHICLES



OFF-ROAD VEHICLES



FARM & GARDEN VEHICLES



PART NO.	35.400.300	
TYPE	FLOOR JACK	JACK STANDS
CAPACITY	3 TON	3 TON
MIN HEIGHT	5.2"	11.3"
MAX HEIGHT	18.3"	16.4"
TOTAL LIFT	13.1"	5.1"

5 - 10 TON LONG FRAME HEAVY DUTY FLOOR JACK

- Innovative design of turbo lift offers a quick lift for professional performance
- Heavy gauge steel frame helps prevent distortion and twisting
- Safety by-pass and over-load systems protect hydraulics
- Foot pedal operated power unit
- Handle-actuated release valve provides metered control at any desired lowering speed
- Wide stance and low center of gravity provide optimum stability under load stress



FOOT PEDAL ASSIST FOR EASY LIFTING



HEAVY DUTY SWIVEL CASTORS WITH FULL 360° MOVEMENT



LONG CHASSIS FOR HARD TO REACH LIFT POINTS



LARGE T-HANDLE PROVIDES SECURE GRIP



PROFESSIONAL

SERIES

PART NO.	35.410.005	35.410.010
CAPACITY	5 TON	10 TON
MINI HEIGHT	6.3"	6.3"
MAX HEIGHT	23.6"	23.6"
TOTAL LIFT	17.3"	17.3"

BUSES

HEAVY TRUCKS

CONSTRUCTION EQUIPMENT

FARM & GARDEN VEHICLES

22 TON AIR / HYDRAULIC FLOOR JACK

- Long 49-1/2" Handle for Hard to Reach Lift Points
- Ideal for Working on Vehicles or Equipment with Overhang



HEAVY DUTY "T" HANDLE WITH THREE LOCKING POSITIONS; 90°, 45°, 0°



SELF-RETURNING SPRING FOR EASE OF OPERATION



BUILT-IN INLINE AIR FILTER TO EXTENDED MOTOR LIFE



ADAPTOR: 3/4", 2-1/4" AND 4" FOR EXTENDED REACH



STEEL WHEEL HUB WITH METAL BEARINGS



WELDED CYLINDER AND RESERVOIR



PROFESSIONAL

SERIES

BUSES

HEAVY TRUCKS

CONSTRUCTION EQUIPMENT

FARM & GARDEN VEHICLES



PART NO.	35.410.022
CAPACITY	22 TON
MINIMUM HEIGHT	9"
MAXIMUM HEIGHT	18"
EXTENSION SCREW	4.2"
HYDRAULIC LIFTING	4.8"

JACK STANDS

2 - 12 TON DOUBLE LOCK JACK STANDS

- Counter-weighted pawl serves as a safe, secure locking device to prevent the load from accidentally disengaging
- Sturdy welded-steel construction for superior safety and strength
- One piece multi-position ductile ratchet bar provides greater strength and durability
- Quick adjustment mechanism that securely locks into desired position



DOUBLE LOCK DESIGN



SINGLE PIECE DUCTILE IRON CASTED RATCHET BAR



HEAVY DUTY STAMPED STEEL CONSTRUCTION



HANDLE WITH SAFETY COUNTER-WEIGHTED PAWL

PROFESSIONAL

SERIES



AUTOMOTIVE VEHICLES



OFF-ROAD VEHICLES



FARM & GARDEN VEHICLES



PART NO.	35.200.002	35.200.003	35.200.006	35.200.012
CAPACITY (PER PAIR)	2 TON	3 TON	6 TON	12 TON
BASE SIZE	7.59" X 6.88"	8.15" X 7.4"	11.22" X 9.84"	11.81" X 10.63"
MINIMUM HEIGHT	11.1"	11.8"	15.7"	17.7"
MAXIMUM HEIGHT	16.9"	17.5"	24.4"	27.5"

10 TON TALL PIN STYLE JACK STANDS

- Includes a Storage Sleeve Welded onto Body
- Superior Quality, Strength and Rigidity and Can Accommodate Vehicles with Panel Rails



PIN IS FASTENED TO BODY BY A TETHER



EXTRA WIDE BASE AND WELDED ON FEET

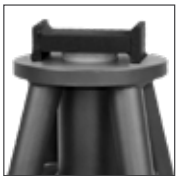

EXTRA WIDE SUPPORT SADDLE



STAMPED STEEL CONSTRUCTION



PART NO.	35.210.010
CAPACITY (PER PAIR)	10 TON
BASE SIZE	16.25" X 16.25"
MINIMUM HEIGHT	28"
MAXIMUM HEIGHT	47.5"

22 TON PIN STYLE TRUCK STANDS

- Provides Superior Strength and Resistance Against Twisting or Bending
- Includes a Knurled Head for a Secure Grip and a Storage Sleeve Welded onto Body



HEAVY GAUGE WELDED STEEL CONSTRUCTION



PIN IS FASTENED TO BODY WITH A TETHER



INCLUDES CONVENIENT CARRY HANDLE



PART NO.	35.210.022
CAPACITY (PER PAIR)	22 TON
BASE SIZE	9.88" X 9.88"
MINIMUM HEIGHT	13.3"
MAXIMUM HEIGHT	19.7"

2 - 20 TON HYDRAULIC BOTTLE JACKS

- Heat-treated extension screw allows for low pick-up height adjustment and maximum lift height
- U.S. patented built-in bypass device protects hydraulic system from overpumping damage
- Unique cross-type forged release valve assures positive control
- Wide rugged base provides stability and strength
- In-line pump allows for easy jack positioning under load

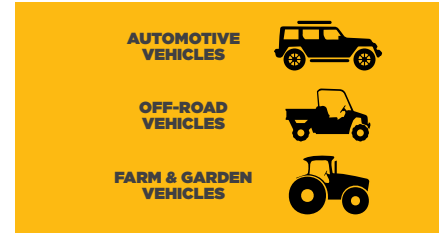

WORKSHOP

SERIES



PART NO.	35.300.002	35.300.004	35.300.006	35.300.008	35.300.012	35.300.112	35.300.020
CAPACITY	2 TON	4 TON	6 TON	8 TON	12 TON	12 TON SHORTY	20 TON
LIFTING	4.5"	4.6"	5"	5.8"	5.9"	3.9"	5.3"
ADJUST	2"	2.4"	2.7"	3.1"	3.1"	2.4"	2.3"
MIN. HEIGHT	7.1"	7.6"	8.5"	9.1"	9.4"	7.5"	9.5"
MAX. HEIGHT	13.6"	14.6"	16.2"	18"	18.4"	13.8"	17.1"

12 - 50 TON HYDRAULIC / AIR BOTTLE JACKS

- A compact yet powerful air turbo motor is equipped to raise the load to the desired height efficiently, effortlessly and safely
- Versatile "quick connector" design provides for easy removal of air hose from air motor allowing compact storage or remote operation
- All air bottle jacks have chrome-plated rams
- Effortless air operation will greatly reduce operator fatigue and speed up the efficiency of garage work

WORKSHOP

SERIES

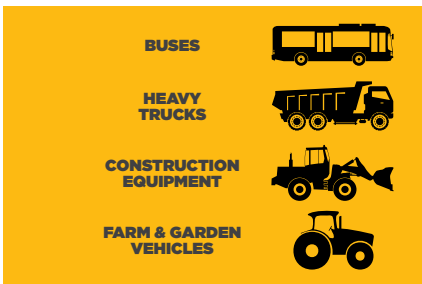

PART NO.	35.310.012	35.310.020	35.300.050
CAPACITY	12 TON	20 TON	50 TON
MINIMUM HEIGHT	9.8"	10.2"	10.6"
MAXIMUM HEIGHT	19.4"	20"	16.9"
HYDRAULIC LIFTING	6.5"	6.7"	6.3"
ADJUSTABLE HEIGHT	3.1"	3.1"	-

1,500 LB MOTORCYCLE / ATV JACK

- Swivel rear heavy duty castor wheels
- Heavy duty Steel Construction provides stability and rigidity
- Non-slip pedal provides easy lifting operation
- Rubber padded lifting platform protects object from scratching

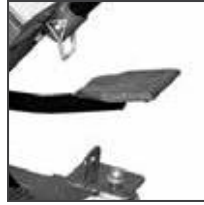

NON-SLIP FOOT PEDAL PROVIDES EASY LIFTING OPERATION

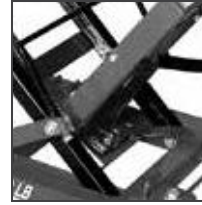

HEAVY DUTY STEEL CONSTRUCTION PROVIDES STABILITY AND RIGIDITY



SELF-ACTING MECHANICAL LOCK CAN BE ENGAGED IN 3 POSITIONS

PROFESSIONAL

SERIES



SWIVEL REAR HEAVY DUTY CASTOR WHEELS



RUBBER PADDED LIFTING PLATFORM PROTECTS OBJECT FROM SCRATCHING



PART NO.	35.001.500
CAPACITY	1,500 LB
LIFTING	9.9"
MIN. HEIGHT	4.6"
MAX. HEIGHT	14.5"

OFF-ROAD VEHICLES



MOTORCYCLES



SNOWMOBILES



4 - 10 TON PORTABLE POWER BODY REPAIR KITS

- Cases are portable for easy use in shop or on the road
- Custom fitted, rugged, blow-molded storage case
- 10 ton set has wheels for easy movement
- A must for body collision repair use
- Designed for applications of pushing, spreading and pressing of vehicle body panels as well as various component parts and assemblies
- A variety of attachments are included
- Pumps are rated from 8,000 to 10,000 PSI



FINISHED WITH OIL, GREASE, AND DIRT RESISTANT PAINT FOR SIMPLE CLEAN UP



HEAVY-DUTY RETURN SPRING RETRACTS RAM SPREADER TO MINIMUM HEIGHT AUTOMATICALLY

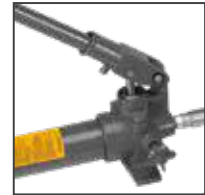

PUMP BUILT WITH AN AUTOMATIC OVERLOAD SYSTEM HELPING PREVENT DAMAGE TO RAMS AND EQUIPMENT



KIT INCLUDES LIFTING, STRAIGHTENING, AND SPREADING ACCESSORIES

WORKSHOP

SERIES



AUTOMOTIVE VEHICLES



OFF-ROAD VEHICLES



FARM & GARDEN VEHICLES



PART NO.	35.100.004	35.100.010
CAPACITY	4 TON	10 TON



ALL PRODUCT FLAG TAGGED/BAR CODED

NEW RETAIL DISPLAY BOARDS

PART#	DESCRIPTION
67.900.002	VERTICAL TOWER
67.900.003	BOARD WITH HOLES
67.900.005	PEG, STEEL W/NUT
67.900.006	BE HEADER SIGNS
67.600.001	TRAILER BALLS
67.600.002	HITCH COUPLERS
67.600.003	TURNBUCKLES
67.600.004	CLEVIS & SHACKLES
67.600.005	FARM LOOSE PINS
67.600.006	CHAIN HOOKS
67.600.007	3 POINT IMP PINS & BUSHINGS
67.600.008	FARM BLISTER PACK PINS
67.600.009	FOLD OVER HITCH PINS
67.600.010	RED HITCH PINS
67.600.011	WIRE ROPE ACCESSORIES
67.600.012	(BE) SMALL ACCESSORIES KITS
67.600.013	GREASE PACKS & ACCESSORIES
67.600.014	RATCHET TIE DOWNS BOARD #1
67.600.015	RATCHET TIE DOWNS BOARD #2
67.600.016	U-BOLTS

ALL ITEMS LABELED WITH UPC CODES

RETAIL DISPLAY BOARDS

TRAILER BALLS RETAIL DISPLAY
67.600.001



HITCH COUPLERS RETAIL DISPLAY
67.600.002



TURNBUCKLE RETAIL DISPLAY
67.600.003



CLEVIS & SHACKLES RETAIL DISPLAY
67.600.004



FARM LOOSE PINS RETAIL DISPLAY
67.600.005



CHAIN HOOKS RETAIL DISPLAY
67.600.006



3 POINT IMPLEMENT PINS & BUSHINGS RETAIL DISPLAY
67.600.007



FARM BLISTER PACK PINS RETAIL DISPLAY
67.600.008



RETAIL DISPLAY BOARDS

**FOLD OVER HITCH PINS
RETAIL DISPLAY**
67.600.009



**RED HITCH PINS
RETAIL DISPLAY**
67.600.010



**WIRE ROPE ACCESSORIES
RETAIL DISPLAY**
67.600.011



**SMALL ACCESSORY KITS
RETAIL DISPLAY**
67.600.012



**GREASE PACKS & ACCESSORIES
RETAIL DISPLAY**
67.600.013



**RATCHET TIE DOWNS
RETAIL DISPLAY #1**
67.600.014



**RATCHET TIE DOWNS
RETAIL DISPLAY #2**
67.600.015



U-BOLTS RETAIL DISPLAY
67.600.016



BOOKING PROGRAM

BE

AG & INDUSTRIAL

BRABEREQ.COM
PARTS@BRABEREQ.COM

PHONE: 604-850-7770
FAX: 604-850-7774
TOLL FREE PHONE: 1-877-588-3311
TOLL FREE FAX: 1-800-665-7334